



We have
the accessories to fit
your space,
to suit your needs

ES

28 años de experiencia nos han permitido desarrollar un programa de productos que nos orgullece, por el nivel de calidad de sus acabados, por el particular estilo de su diseño y por su gran funcionalidad.

En este programa que les presentamos, estamos seguros de que encontrará el complemento que se adecua más a sus necesidades.

Un producto de calidad para diferentes ambientes, que proporcionara un toque de innovación, diseño y funcionalidad...

Oficinas – Universidades – Centros comerciales – Estaciones de tren y Aeropuertos – Bibliotecas – Hoteles – Espacios públicos y privados.

EN

28 years experience has given us the chance to develop a catalogue of products that we are very proud of, thanks to the quality of their finishes and their unique design and practical features.

In this catalogue, we are confident you can find the items best-suited to your needs.

A product of high quality for diverse environments, which comes with a touch of innovation, design and functionality...

Offices - Universities – Shopping centres - train stations and airports – libraries – hotels – public and private areas.

FR

28 années d'expérience nous ont permis de développer un programme de produits dont nous sommes fiers, tant par la qualité de ses finitions et le style particulier de sa conception que par son importante fonctionnalité.

Nous sommes sûrs que vous trouverez parmi le programme que nous présentons, le complément qui s'adapte le mieux à vos besoins.

Un produit de qualité pour différents environnements, qui fournit une touche d'innovation, de design et de fonctionnalité...

Bureaux - Universités - Centres Commerciaux – Gares et Aéroports - Bibliothèques - Hôtels Espaces publics et privés.

DE

28 Jahre Erfahrung erlauben uns eine Produktpalette darzulegen welche uns, aufgrund ihrer hochwertigen Verarbeitung, ihrem einzigartigem Design und ihrer großartigen Funktionalität, mit Stolz erfüllt.

In der folgenden Produktpalette, die wir Ihnen vorstellen, sind wir sicher, dass Sie das Accessoire finden, das sich Ihren Bedürfnissen am besten anpasst.

Ein Qualitätsprodukt für unterschiedliche Umgebungen um einem Hauch von Innovation, Design und Funktionalität zu bieten...

Büros - Hochschulen - Einkaufszentren - Bahnhöfe und Flughäfen - Bibliotheken - Hotels-öffentlicher und privater Raum.



Uno de nuestros objetivos principales, es buscar soluciones a las necesidades de nuestros clientes. Por este motivo ofrecemos la posibilidad de crear un producto personalizado, permitiendo modificar características del artículo como el diseño, las medidas, los colores e incluso añadiendo la marca o el logotipo del cliente.

One of our main objectives is to look for solutions for the needs of our customers. For that reason we offer the possibility to create a personalized product, allowing to modify the characteristics, design, formats or colour of the item and even adding the logo or brand of the client.

Un de nos principaux objectifs est de trouver des solutions aux besoins de nos clients. Pour cette raison, nous offrons la possibilité de créer un produit personnalisé, en permettant de modifier les caractéristiques de l'article ainsi que le design, les dimensions, les couleurs et même y ajouter la marque ou le logo du client.

Eines unsere Hauptziele ist, für die Bedürfnisse unserer Kunden Lösungen zu finden. Deswegen bieten wir die Möglichkeit ein maßgeschneidertes Produkt zu kreieren, wobei die Merkmale des Artikels insbesondere Design, Maße, Farben und sogar die Firmenmarke oder das Kundenlogo modifiziert werden können.



Producto Personalizado



Custom product



Produit personnalisé



Zugeschnittenes Produkt



Bajo pedido se puede fabricar en más gamas de colores, consultar.



If requested the item can be made in a wider spectrum of colours



Sur demande, nous pouvons fabriquer en d'autres couleurs, consultez.



Kann auf Anfrage in mehreren Farbvariationen hergestellt werden. Lassen Sie sich durch uns beraten.



FABRICANTES - INVESTIGACIÓN, DESARROLLO, INNOVACIÓN - PRODUCTOS DE CALIDAD - DISEÑO - SERVICIO – PRODUCTOS PERSONALIZADOS

MANUFACTURERS - RESEARCH, DEVELOPMENT AND INNOVATION - QUALITY PRODUCTS - DESIGN - SERVICE – CUSTOM PRODUCTS

FABRICANTS - RECHERCHE, DÉVELOPPEMENT, ET INNOVATION - PRODUITS DE QUALITÉ - DESIGN - SERVICE – PRODUITS PERSONNALISÉS

HERSTELLERN - FORSCHUNG, ENTWICKLUNG UND INNOVATION - QUALITÄTSPRODUKTE - DESIGN - DIENSTLEISTUNG – MAßGESCHNEIDERTE PRODUKTE

EXPOSITORES
 DISPLAY STANDS
 PRÉSENTOIRS
 PROSPEKTHALTER

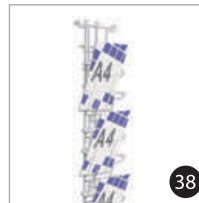
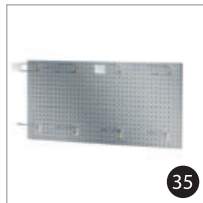
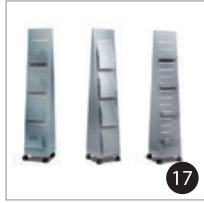
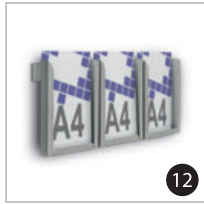

PAPELERAS
 WASTEPAPER BASKETS
 CORBEILLES À PAPIER
 PAPIERKÖRBE



COMPLEMENTOS
ACCESSORIES
COMPLÉMENTS
ZUBEHÖR

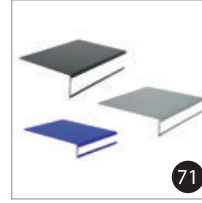
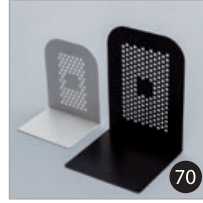
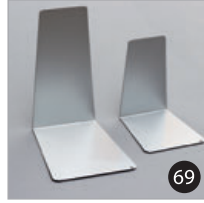
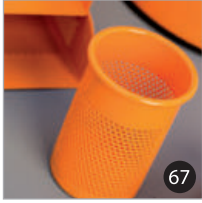
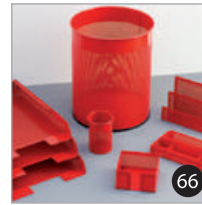
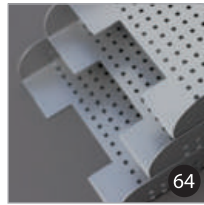

POSTES DE CINTA EXTENSIBLE RETRÁCTIL
RETRACTABLE BELT POSTS
POTEAUX À SANGLE RÉTRACTABLE
ABSPERRSTÄNDER MIT AUSZIEHBAREM BAND

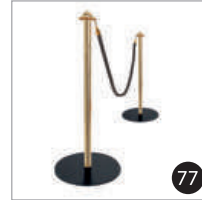

SISTEMAS DE SEÑALIZACIÓN
SIGNALLING SYSTEMS
SYSTÈMES DE SIGNALISATION
SIGNALSYSTEME

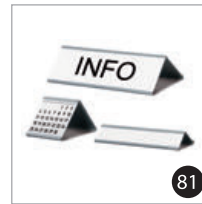
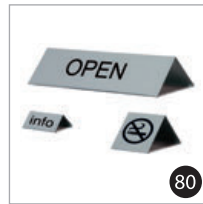

PERCHEROS
COAT RACKS
PORTEMANTEAUX
GARDEROBEN

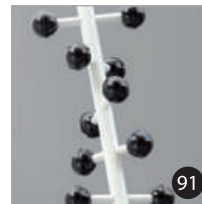
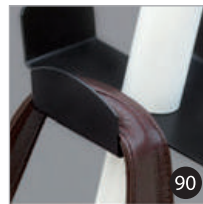
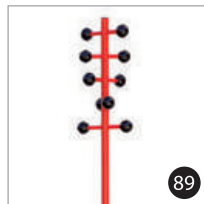

CARRO AUXILIAR
SIDE TROLLEY
CHARIOT AUXILIAIRE
MOBILER BEISTELLTISCH

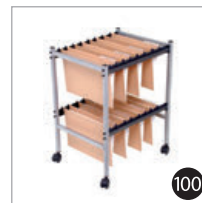
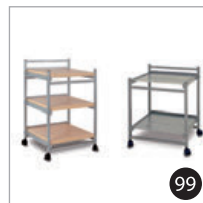
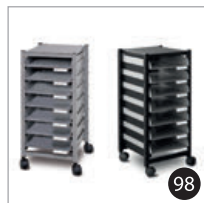

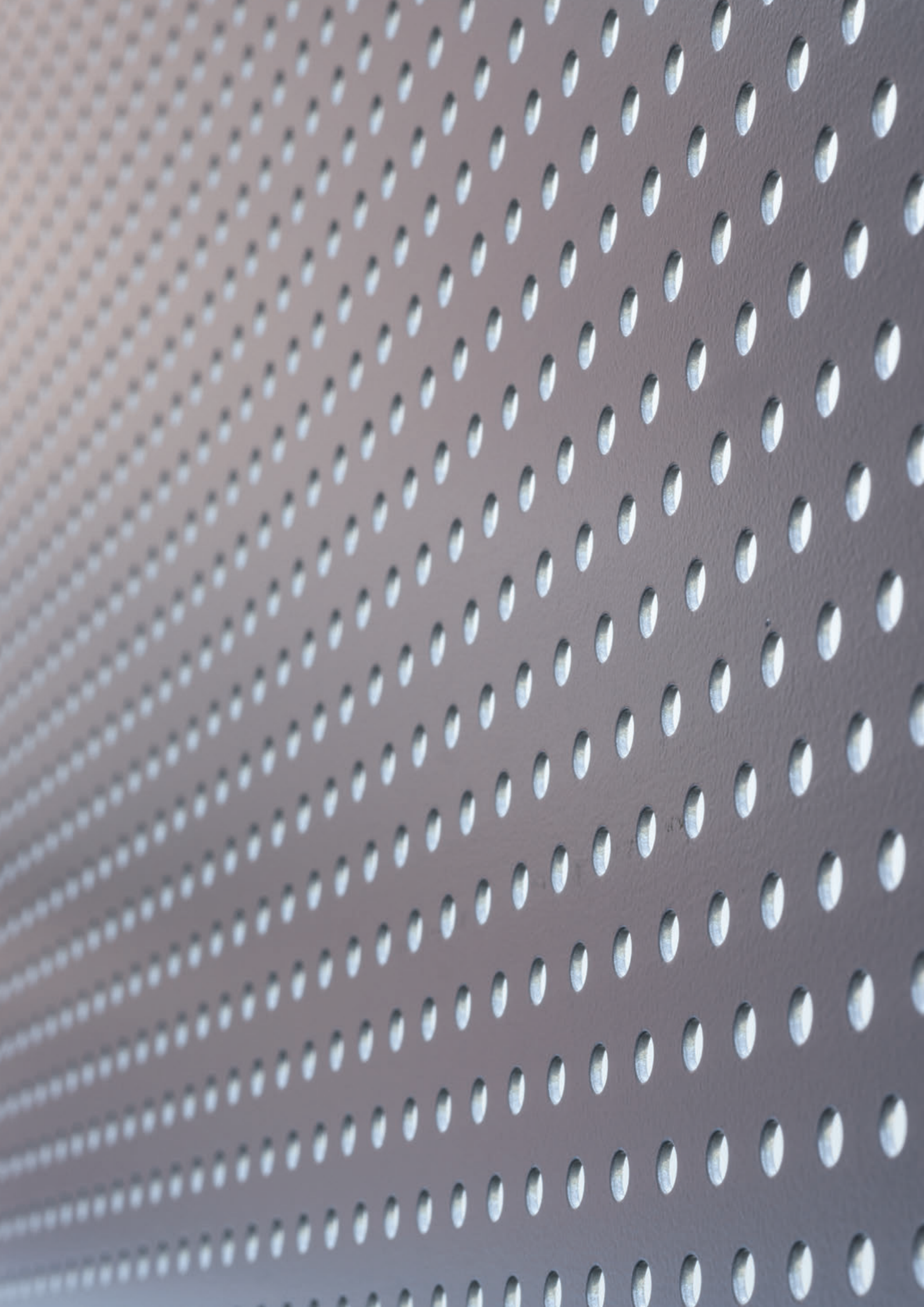

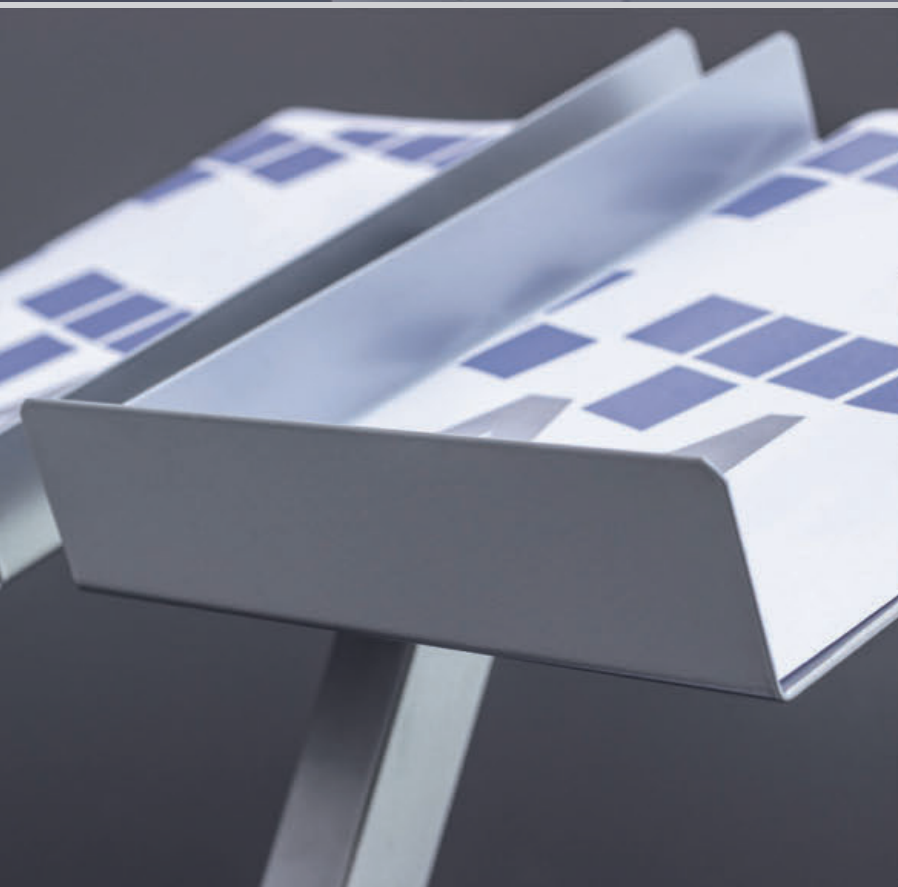
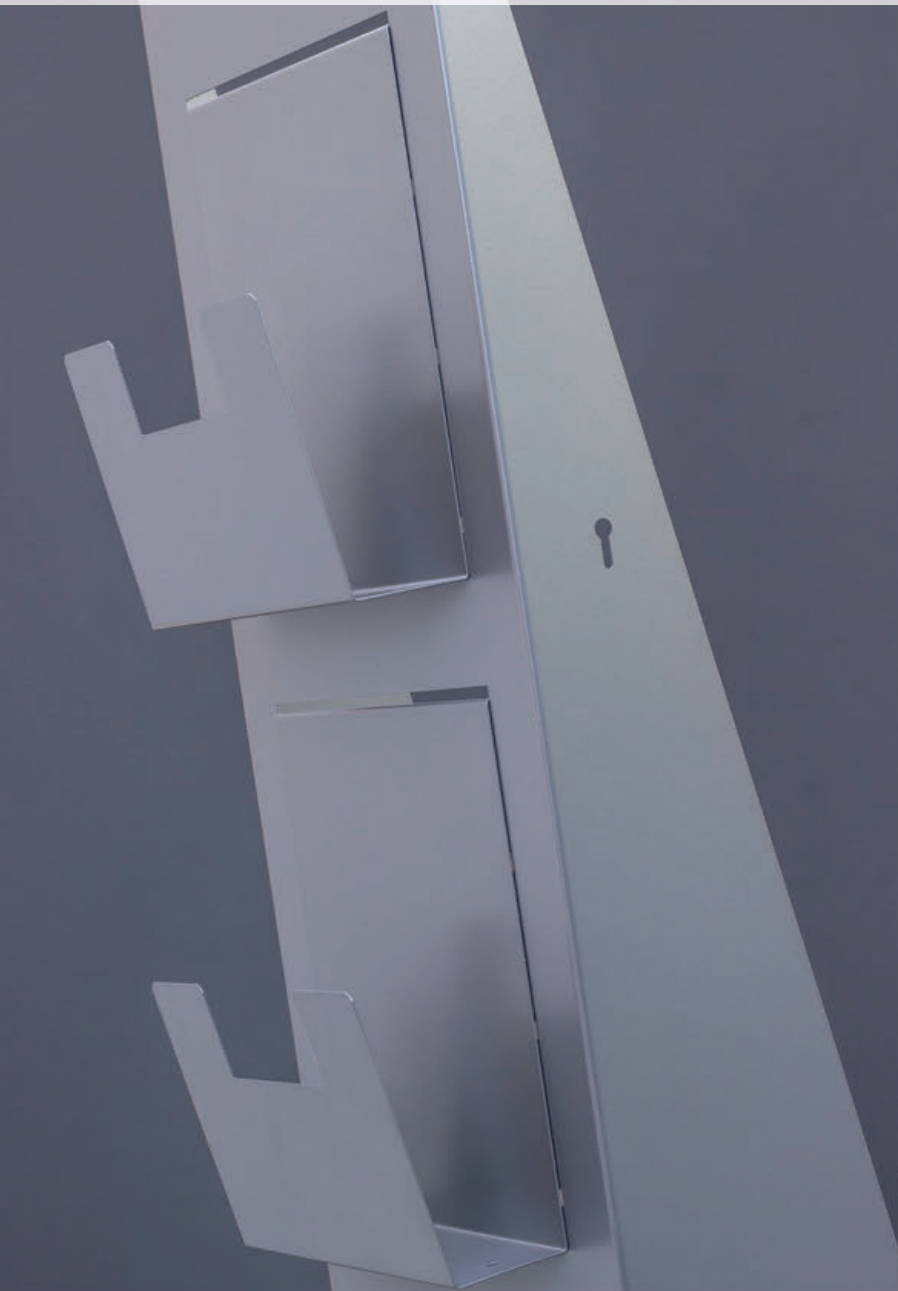



1014 09

1008 09

ES Expositor de pared metálico de gran utilidad para situar toda clase de documentos: propaganda, folletos, correspondencia, fichas, expedientes, etc.
Disponible en varios formatos: Din A4V, Din A4H, Din A5V, Din A5H, 1/3 Din A4V (formato tríptico), 1/3 Din A4H (formato tríptico).
Se suministra en packs de 3 y 6 departamentos.

EN Wall-mounted metal display stand, with great utility for placing all kinds of documents: advertising materials, brochures, correspondence, forms, files, etc.
Available in various formats: DIN A4V, Din A4H, Din A5V, Din A5H, 1/3 Din A4V (leaflet format), 1/3 Din A4H (leaflet format).
Shipped in packs of 3 and 6 units.

FR Présentoir métallique mural, utile à placer toutes sortes de documents : publicité, brochure, courrier, fiches, dossiers, etc.
Disponible en différents formats: Din A4V, Din A4H, Din A5V, Din A5H, 1/3 Din A4V (format triptyque), 1/3 Din A4H (format triptyque).
Il est fourni en paquets de 3 et 6 compartiments.

DE Wandprospektregal aus Metall um Dokumente jeder Art aufzubewahren : Werbung, Faltprospekte, Briefpost, Karteikarten, Akten etc.
in verschiedenen Formaten verfügbar: Din A4V, Din A4H, Din A5V, Din A5H, 1/3 Din A4V (Triptychon Format), 1/3 Din A4H (Triptychon Format).
Lieferbar in 3 und 6 Fächer Pack.





Ref.	A	B	C	D
1008_	28 cm	24 cm	1,5 cm	3
1014_	28 cm	24 cm	1,5 cm	6

02 03 09 A4V

Ref.	A	B	C	D
1008K_	28 cm	24 cm	1,5 cm	3
1014K_	28 cm	24 cm	1,5 cm	6

02 03 09 A4V



Ref.	A	B	C	D
1012_	21,5 cm	16,5 cm	1,5 cm	3
1018_	21,5 cm	16,5 cm	1,5 cm	6

02 03 09 A5V

Ref.	A	B	C	D
1012K_	21,5 cm	16,5 cm	1,5 cm	3
1018K_	21,5 cm	16,5 cm	1,5 cm	6

02 03 09 A5V



Ref.	A	B	C	D
1010_	21,5 cm	13 cm	1,5 cm	3
1016_	21,5 cm	13 cm	1,5 cm	6

02 03 09 1/3 A4V

Ref.	A	B	C	D
1010K_	21,5 cm	13 cm	1,5 cm	3
1016K_	21,5 cm	13 cm	1,5 cm	6

02 03 09 1/3 A4V



Ref.	A	B	C	D
1009_	21,5 cm	31,5 cm	1,5 cm	3
1015_	21,5 cm	31,5 cm	1,5 cm	6

02 03 09 A4H

Ref.	A	B	C	D
1009K_	21,5 cm	31,5 cm	1,5 cm	3
1015K_	21,5 cm	31,5 cm	1,5 cm	6

02 03 09 A4H



Ref.	A	B	C	D
1013_	15 cm	24 cm	1,5 cm	3
1019_	15 cm	24 cm	1,5 cm	6

02 03 09 A5H

Ref.	A	B	C	D
1013K_	15 cm	24 cm	1,5 cm	3
1019K_	15 cm	24 cm	1,5 cm	6

02 03 09 A5H



Ref.	A	B	C	D
1011_	10,5 cm	24 cm	1,5 cm	3
1017_	10,5 cm	24 cm	1,5 cm	6

02 03 09 1/3 A4H

Ref.	A	B	C	D
1011K_	10,5 cm	24 cm	1,5 cm	3
1017K_	10,5 cm	24 cm	1,5 cm	6

02 03 09 1/3 A4H

ES Ejemplo de pedido:
Referencia del producto +
Referencia color

EN Order Example:
Product reference + Color
Reference

FR Exemple de commande:
Référence produit +
référence couleur

DE Bestellbeispiel:
Referenz des Produkts +
Farbe Referenz



1008 03

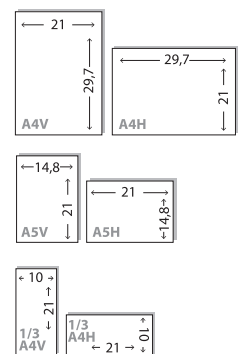
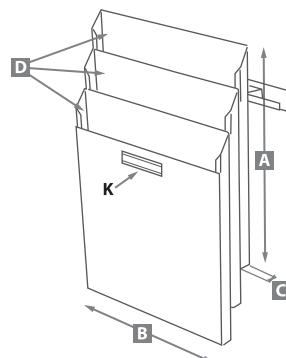

Ejemplo de montaje / Mounting example / Exemple de montage / Montagebeispiel



1 A4V S + 8 A4V M + 1 A4V F 09

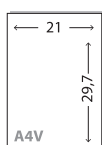

Ref.

A4V S_
A4V M_
A4V F_

02 03 09

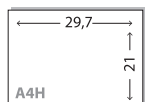

Ref.

A4H S_
A4H M_
A4H F_

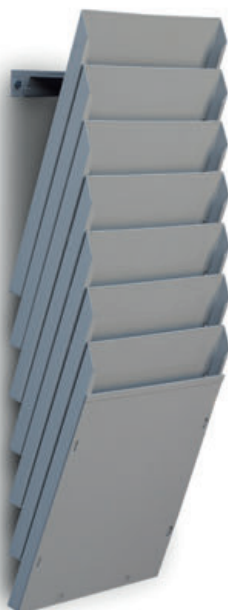

1 A4V S + 6 A4V M + 1 A4V F 09



Ref.

A5V S_
A5V M_
A5V F_

02 03 09

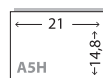

Ref.

A5H S_
A5H M_
A5H F_



1 A4V S + 4 A4V M + 1 A4V F 09

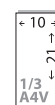

Ref.

1/3 A4V S_
1/3 A4V M_
1/3 A4V F_

02 03 09

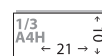

Ref.

1/3 A4H S_
1/3 A4H M_
1/3 A4H F_

ES Expositor de pared metálico, ideal para poder crear columnas con el número de compartimentos que se precise.

Producto compuesto de tres piezas:

Soporte de pared ref. **S** (primer compartimento para ser fijado en la pared).
Intermedio ref. **M** (referencia que nos permite ir añadiendo compartimentos al expositor).

Tapa final ref. **F** (tapa para cerrar el último compartimento).

EN Wall-mounted metal display stand, ideal to set up columns with any number of compartments necessary. The product consists of three parts:

Wall bracket model **S** (the first compartment attaches the item to a wall).

Intermediate model **M** (the model allows us to add compartments to the showcase).

Cover model **F** (cover to close the last compartment).

FR Présentoir métallique mural, idéal pour créer des colonnes avec le nombre de compartiments nécessaires

Produit composé de trois parties:

Support mural Réf. **S** (premier compartiment à être fixé au mur).

Intermédiaire Réf. **M** (référence qui nous permet d'ajouter des compartiments au présentoir).

Couvercle finale Réf. **F** (couvercle pour fermer le dernier compartiment).

DE Wandprospektregal aus Metall mit dem man mehrere Kolonnen mit mehreren Einheiten bilden kann.

Aus drei Modulen zusammengesetzt:

Wandhalterung Ref. **S** (das erste Segment kann an der Wand platziert werden).

Zwischenstück Ref. **M** (Es können bei Bedarf mehrere Segmente angefügt werden).

Endstück Ref. **F** (Endstück um das letzte Segment abzudecken).

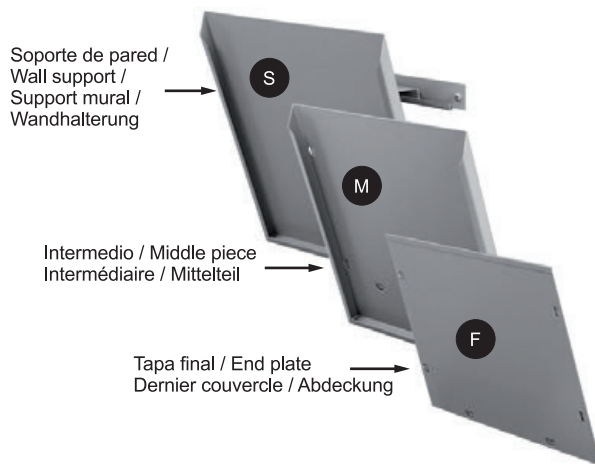



1020K 02



1021 03

1022 03

1020 03

ES Expositor de pared metálico.
Incluye accesorios para instalación.

EN Wall-mounted metal display stand.
Installation accessories included.

FR Présentoir métallique mural.
Les accessoires pour l'installation sont inclus.

DE Wandprospektregal aus Metall.
Enthält Zubehör zur Installation an Wänden.

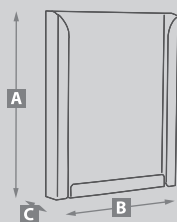
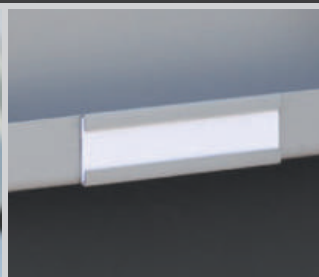

	A	B	C	
Ref. 1020_	27,5 cm	22,5 cm	3,5 cm	A4V
Ref. 1022_	20 cm	16,5 cm	3,5 cm	A5V
Ref. 1021_	20 cm	11,5 cm	3,5 cm	1/3 A4V
 K	01	02	03	



1147 03



1147 02

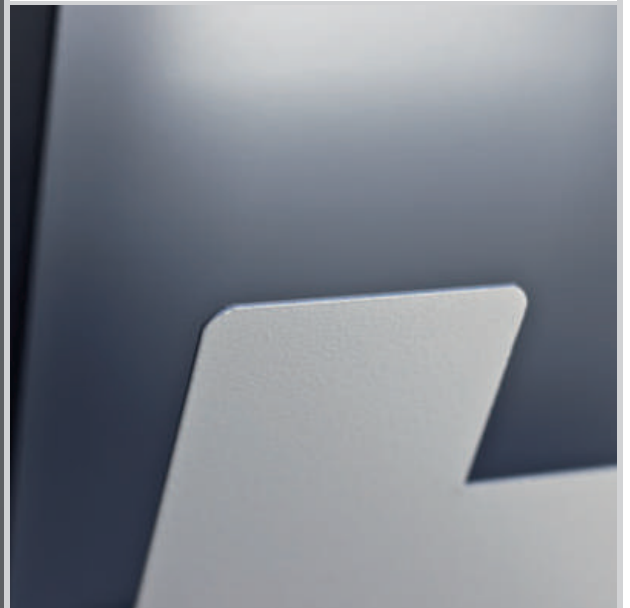

ES Expositor metálico de pared para revistas y catálogos. Incluye accesorios para instalación.

EN Wall-mounted metal display stand, for magazines and catalogues. Installation accessories included.

FR Présentoir métallique mural, pour revues et catalogues. Les accessoires pour l'installation sont inclus.

DE Wandprospektregal aus Metall, für Zeitschriften und Kataloge. Enthält Zubehör zur Installation an Wänden.

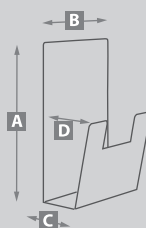

Ref. 1147_ **A** 27,5 cm **B** 22 cm **C** 6,5 cm **D** 10 cm **A4V**

01 **02** **03**



0861_02



0820_02



0821_02



0822_02

ES Expositor de sobremesa metálico. Incluyen protecciones inferiores para no rayar la superficie donde se sitúe.

EN Tabletop display stand. Includes base protectors to prevent scratching the surface it is placed on.

FR Présentoir de bureau métallique. Protections inférieures incluses pour ne pas rayer la surface sur laquelle il est placé.

DE Tischprospekthalter aus Metall. Beinhaltet Kratzschutz.

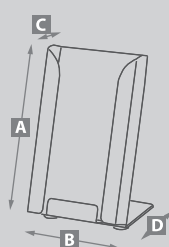

	A	B	C	D	
Ref. 0820_	27,5 cm	22,5 cm	3,5 cm	13 cm	A4V
Ref. 0822_	20 cm	16 cm	3,5 cm	12 cm	A5V
Ref. 0821_	20 cm	11,5 cm	3,5 cm	12 cm	1/3 A4V
Ref. 0861_	20 cm	23 cm	3,5 cm	12 cm	1/3 A4V x 2
	01	02	03		



114802/3 02

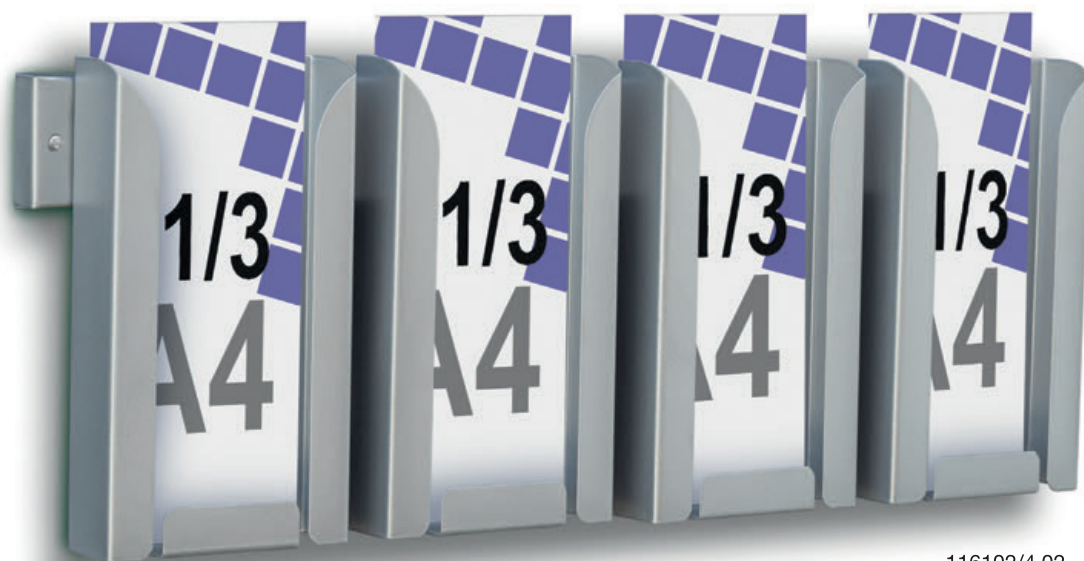

116102/4 02

ES Expositor metálico de pared, pintado en color plata. Disponible en 6 modelos, 2 o 3 departamentos formato Din A4V i 2,3,4 o 5 departamentos formato 1/3 Din A4V (formato tríptico).

EN Silver painted wall-mounted metal display stand. Available in 6 models: 2 or 3 A4 portrait format departments and 2,3,4 or 5 1/3 A4 portrait (leaflet format) format departments.

FR Présentoir métallique mural, peint en argent. Disponible en 6 modèles, 2 ou 3 compartiments Din A4V et 2,3,4 ou 5 compartiments format 1/3 DIN A4V (format triptyque).

DE Wandprospektregal aus Metall in Silber lackiert. In sechs Varianten: 2 oder 3 Fächer Format Din A4V und 2,3,4 oder 5 Fächer Format 1/3 Din A4V (Triptychon Format).

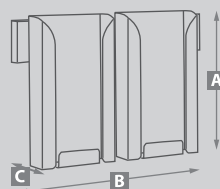

Ref.	A	B	C	Format	Quantity
114802_	27,5 cm	49 cm	5,5 cm	A4V	X 2
114802/3_	27,5 cm	72 cm	5,5 cm	A4V	X 3
116102_	20 cm	31,5 cm	5,5 cm	1/3 A4V	X 2
116102/3_	20 cm	45 cm	5,5 cm	1/3 A4V	X 3
116102/4_	20 cm	58,5 cm	5,5 cm	1/3 A4V	X 4
116102/5_	20 cm	72 cm	5,5 cm	1/3 A4V	X 5

01 02 03

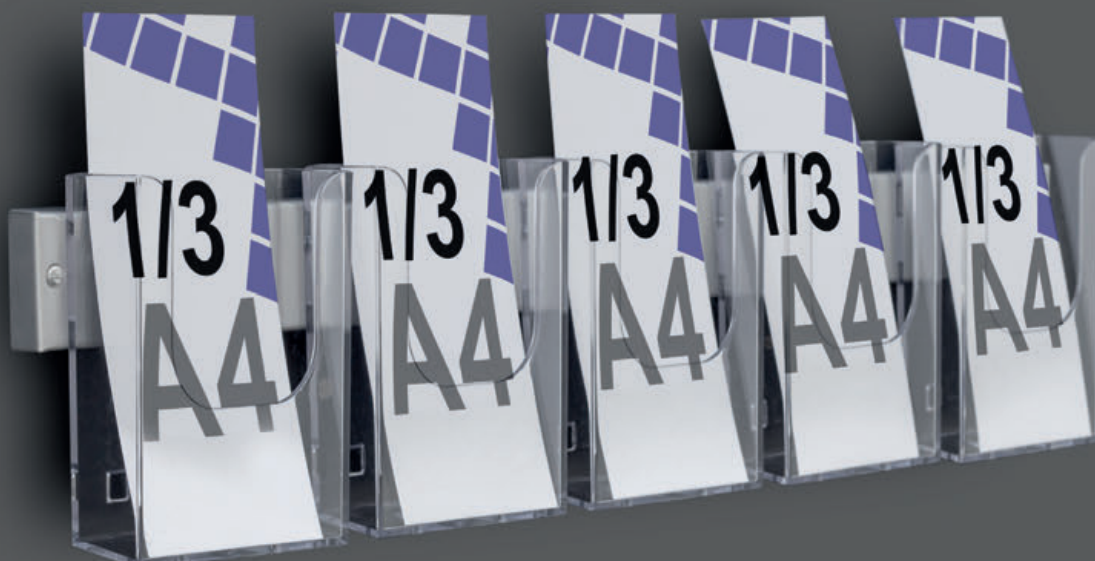

116146/5

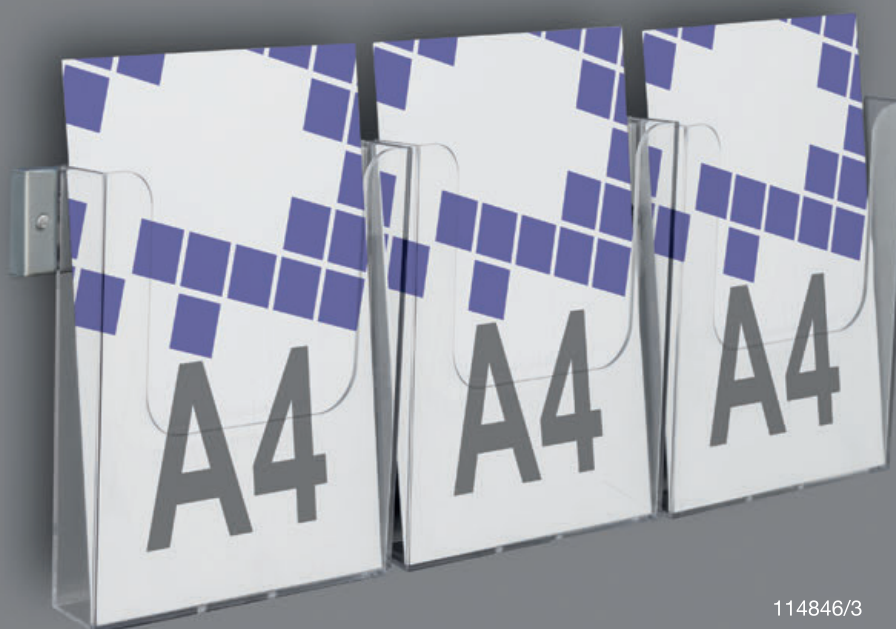

114846/3

ES Expositor de pared con soporte fabricado en metal y porta folletos de poliestireno. Disponible en 6 modelos, 2 o 3 departamentos formato Din A4V i 2,3,4 o 5 departamentos formato 1/3 Din A4V (formato tríptico).

EN Wall-mounted display stand with foundation made of metal and polystyrene leaflet holder. Available in 6 models: 2 or 3 A4 portrait format departments and 2,3,4 or 5 1/3 A4 portrait (leaflet format) format departments.

FR Présentoir mural avec support fabriqué en métal et porte-brochures en polystyrène. Disponible en 6 modèles, 2 ou 3 compartiments Din A4V et 2,3,4 ou 5 compartiments format 1/3 DIN A4V (format triptyque).

DE Wandprospektregal mit Metallhalterung und Prospekthalter aus Polystyrol. In sechs Varianten: 2 oder 3 Fächer Format Din A4V und 2,3,4 oder 5 Fächer Format 1/3 Din A4V (Triptychon Format).

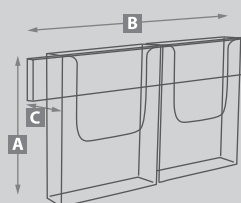

	A	B	C	
Ref. 114846	27,5 cm	49 cm	5,5 cm	A4V x 2
Ref. 114846/3	27,5 cm	72 cm	5,5 cm	A4V x 3
Ref. 116146	15 cm	31,5 cm	5,5 cm	1/3 A4V x 2
Ref. 116146/3	15 cm	45 cm	5,5 cm	1/3 A4V x 3
Ref. 116146/4	15 cm	58,5 cm	5,5 cm	1/3 A4V x 4
Ref. 116146/5	15 cm	72 cm	5,5 cm	1/3 A4V x 5

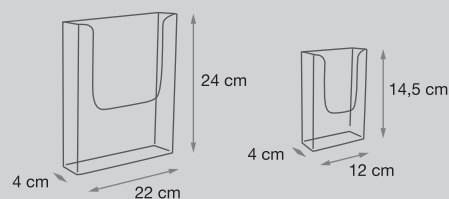



082046



082246



086146

ES Expositor de sobremesa, con soporte metálico pintado en plata y porta folletos en poliestireno. Disponible en 3 formatos: Din A4V, Din A5V y 1/3 Din A4V.

EN Table top display stand with metal foundation painted in silver and polystyrene leaflet holder. Available in three formats; DIN A4V, Din A5V and 1/3 Din A4V.

FR Présentoir de bureau, avec support métallique peint en argent et porte-brochures en polystyrène. Disponible en 3 formats : Din A4V, Din A5V et 1/3 Din A4V

DE Tischprospekthalter mit Metall Halterung in Silber lackiert und Prospekthalter aus Polystyrol. In 3 Formaten lieferbar: Din A4V, Din A5V und 1/3 Din A4V.

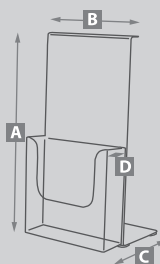

	A	B	C	D	
Ref. 082046	38 cm	22 cm	12 cm	4 cm	A4V
Ref. 082246	30,5 cm	17 cm	12 cm	4 cm	A5V
Ref. 086146	30,5 cm	25 cm	12 cm	4 cm	1/3 A4V x 2



2161 03



2159 02



2154 02

ES Expositor de pared metálico, pintado en color plata. Paneles fabricados en metal donde se sitúan portafolletos DIN A4V, 1/3 DIN A4V (formato tríptico).

EN Silver painted wall-mounted metal display stand. Metal panels, on which DIN A4V, 1/3 DIN A4V (tri-fold size) leaflet holders are fitted.

FR Présentoir métallique mural, peint en argent. Panneaux fabriqués en métal où sont situés les porte-brochures DIN A4V, 1/3 DIN A4V (format triptyque).

DE Wandprospektregal aus Metall, in Silber. Blende hergestellt Blech, an der man die Halterungen, DIN A4V, 1/3 DIN A4V (Faltprospekte).

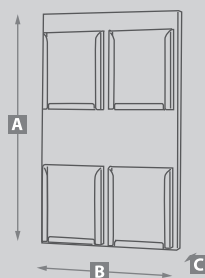

	A	B	C	
Ref. 2161_	83,5 cm	51 cm	8 cm	$\frac{1}{3}$ A4V X 8
Ref. 2154_	83,5 cm	51 cm	8 cm	A4V X 4
Ref. 2159_	83,5 cm	51 cm	8 cm	A4V X 2 + $\frac{1}{3}$ A4V X 4

02 03



115702

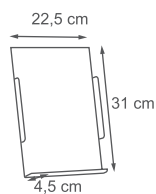

115502

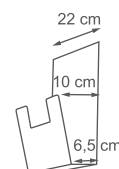

ES Expositor metálico de pared, pintado en plata, con ranuras para la colocación de 4 bandejas en ángulo recto o ángulo inclinado, según se precise.

EN Silver painted wall-mounted metal display stand, with slots to position the 4 trays either at a right angle or at a slanting angle, as required.

FR Présentoir métallique mural, peint en argent, avec rainures pour placer 4 plateaux à angle droit ou incliné, selon les besoins.

DE Wandprospektregal aus Metall, in Silber mit Schlitz für die Anordnung von 4 geneigten oder rechtwinkligen Ablagen, je nach Bedarf.

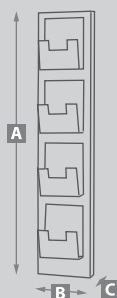

	A	B	C	
Ref. 115702	148,5 cm	31 cm	3,5 cm	A4V x 4
Ref. 115502	148,5 cm	31 cm	3,5 cm	A4V x 4



135502 R

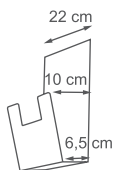

135702 R

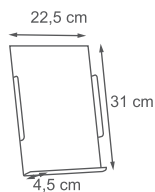

135402 R

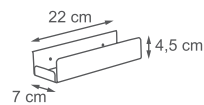

ES Expositor metálico móvil, pintado en plata, con ranuras para la colocación de 4 bandejas en ángulo recto o ángulo inclinado, según se precise.

EN Silver painted Moveable metal display stand, with slots to position the 4 trays either at a right angle or at a slanting angle, as required.

FR Présentoir métallique mobile, peint en argent, avec rainures pour placer 4 plateaux à angle droit ou inclinés, selon les besoins.

DE Metallprospekthalter mit Rollen, in Silber mit Schlitz für die Anordnung von 4 geneigten oder rechtwinkligen Ablagen, je nach Bedarf.

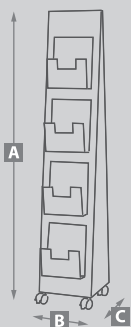

	A	B	C	
Ref. 135502_	157 cm	30,5 cm	30 cm	A4V X 4
Ref. 135702_	157 cm	30,5 cm	30 cm	A4V X 4
Ref. 135402_	157 cm	30,5 cm	30 cm	A4V X 4



138202

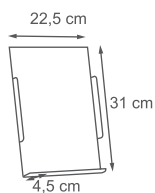

135802

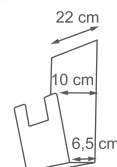

ES Expositor metálico de pie, pintado en plata, con ranuras para la colocación de 8 bandejas en ángulo recto o ángulo inclinado, según se precise.

EN Silver painted free standing metal display stand, with slots to position the 8 trays either at a right angle or at a slanting angle, as required.

FR Présentoir métallique sur pied, peint en argent, avec rainures pour placer 8 plateaux à angle droit ou incliné, selon les besoins.

DE Prospektständer aus Metall, in Silber mit Schlitz für die Anordnung von 8 geneigten oder rechtwinkligen Ablagen, je nach Bedarf.

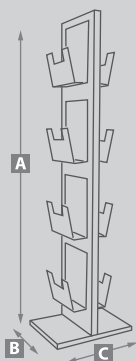

	A	B	C	
Ref. 138202	148,5 cm	33 cm	40 cm	A4V x 8
Ref. 135802	148,5 cm	33 cm	40 cm	A4V x 8



125002



125202



125102

ES Expositor de pie. Diferentes modelos desde 1 a 6 estantes. Artículo metálico pintado en plata.

EN Free standing display stand. Different models with between 1 an 6 shelves. Silver painted.

FR Présentoir sur pied. Différents modèles a 1 a 6 rangées. Peint en argent.

DE Prospekthalterständer. Verschiedene Modelle mit bis zu sechs Fächern. In silber.

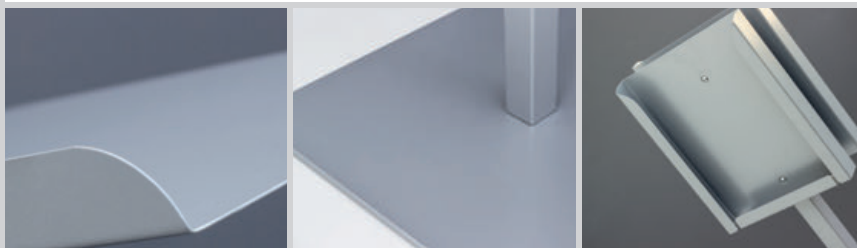

	A	B	C	
Ref. 125202	109,5 cm	33 cm	33 cm	A4V X 1 + 1/3 A4V X 1
Ref. 125002	101 cm	33 cm	33 cm	A4V X 2
Ref. 125102	109,5 cm	33 cm	33 cm	A4V X 2

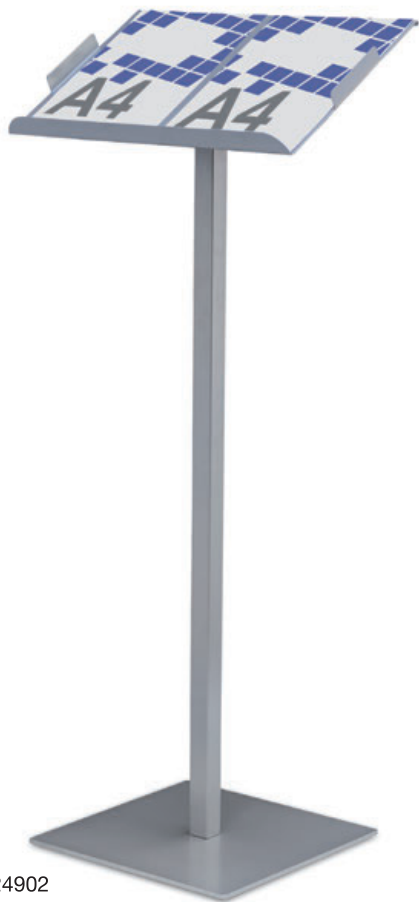

124902



235102



127002

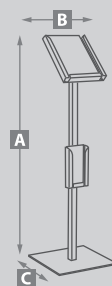
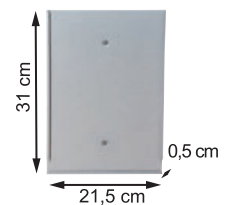
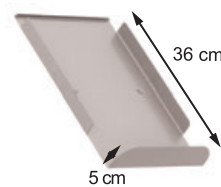
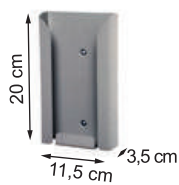

	A	B	C	
Ref. 127002	111,5 cm	33 cm	33 cm	A4V x 2
Ref. 124902	109,5 cm	45,5 cm	33 cm	A3H x 1
Ref. 235102	114,5 cm	33 cm	33 cm	A4V x 2

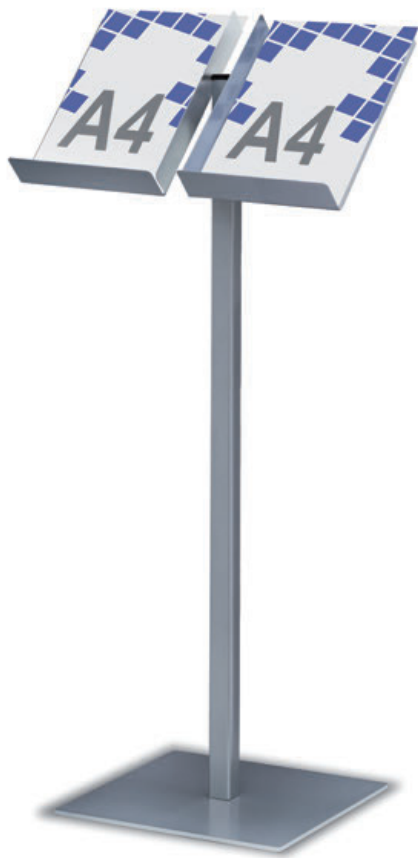

125302



125502

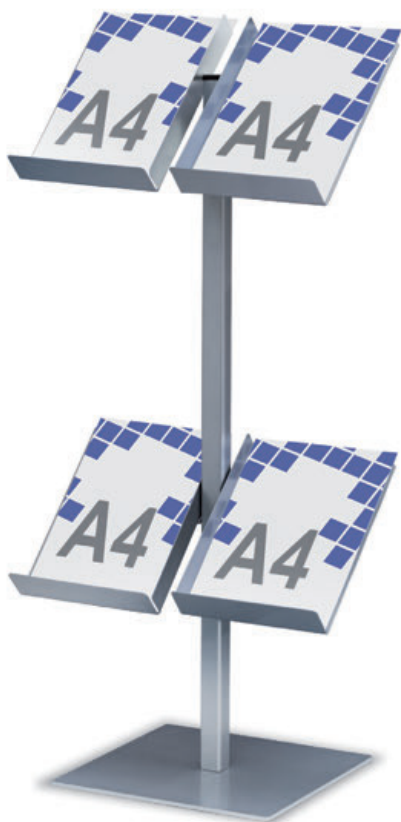

125402

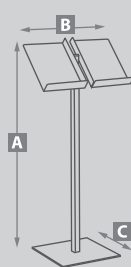
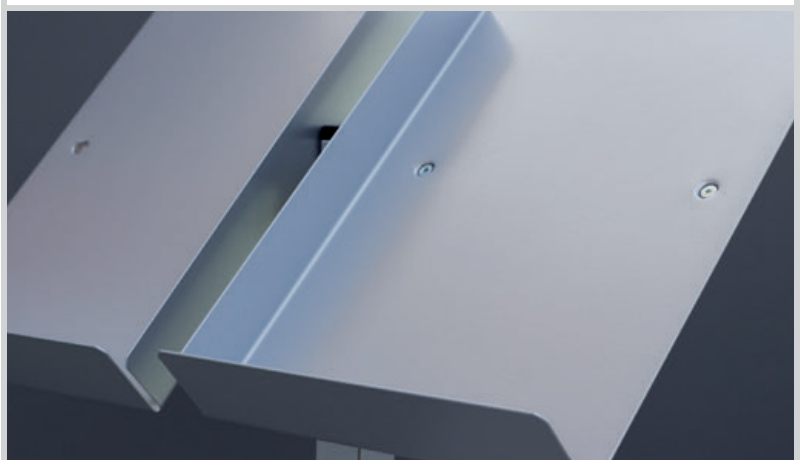

	A	B	C	
Ref. 125302	101 cm	48 cm	33 cm	A4V X 2
Ref. 125402	101 cm	48 cm	33 cm	A4V X 4
Ref. 125502	151 cm	48 cm	33 cm	A4V X 6



15130 R

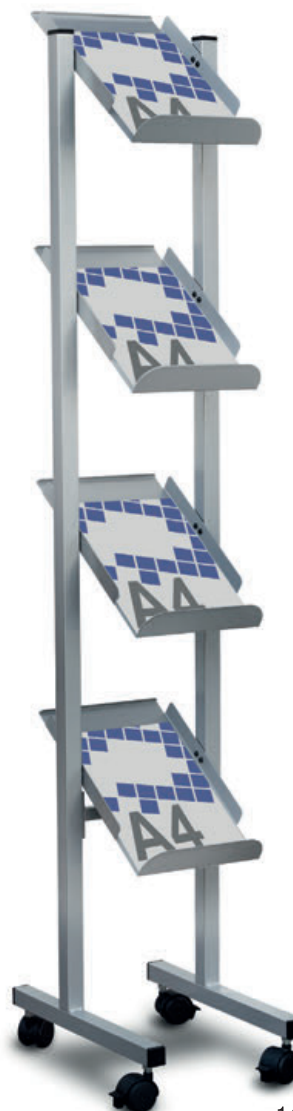

14130 R

ES Expositor con estructura de acero y estantes fabricados en metal laminado, pintado en color plata. Disponible en dos versiones: con o sin rótulo en la parte superior.

EN Free standing display stand with steel structure and shelves made of sheet metal, painted in silver. Available in two versions: with or without sign on the upper part.

FR Présentoir structure en acier et des étagères en tôle peintes en argent. Disponible en deux versions: avec ou sans étiquette à la partie supérieure.

DE Prospekthalterständer mit aus Metallwalz hergestellter Stahlstruktur und Regale, in Silber lackiert. In zwei Modellen lieferbar: mit oder ohne Schild oben.

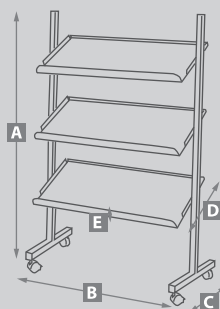

	A	B	C	D	E	
Ref. 14130_	168 cm	29 cm	41 cm	36 cm	5 cm	A4V X 4
Ref. 15130_	183,5 cm	29 cm	41 cm	36 cm	5 cm	A4V X 4





15131 R



14131 R

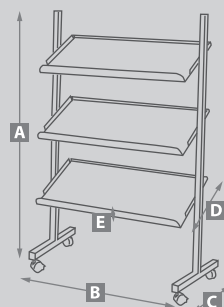

	A	B	C	D	E	
Ref. 14131_	168 cm	51 cm	41 cm	36 cm	5 cm	A4V x 8
Ref. 15131_	183,5 cm	51 cm	41 cm	36 cm	5 cm	A4V x 8











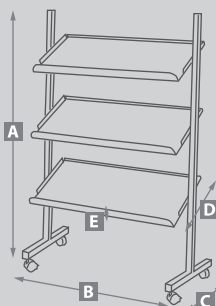
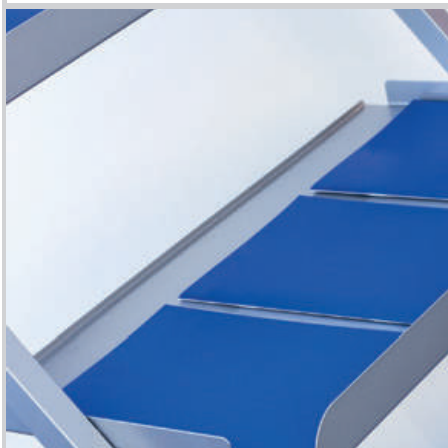

15132 R



14132 R



	A	B	C	D	E	
Ref. 14132_	168 cm	74,5 cm	41 cm	36 cm	5 cm	 A4V x 12
Ref. 15132_	183,5 cm	74,5 cm	41 cm	36 cm	5 cm	 A4V x 12
						 _R  _N
Ref. 14132	159 cm	104,5 cm	41 cm	36 cm	5 cm	 A4V x 12
Ref. 15132	174 cm	104,5 cm	41 cm	36 cm	5 cm	 A4V x 12
						



1457R 02

1456B 02



ES Expositor metálico pintado en negro o plata, con 3 o 4 estantes situados frontalmente.

EN Black or silver painted metal display stand with 3 or 4 shelves positioned at the front.

FR Présentoir métallique peint en noir ou argent, avec 3 ou 4 rangées sur la partie frontale.

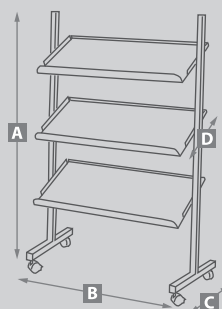
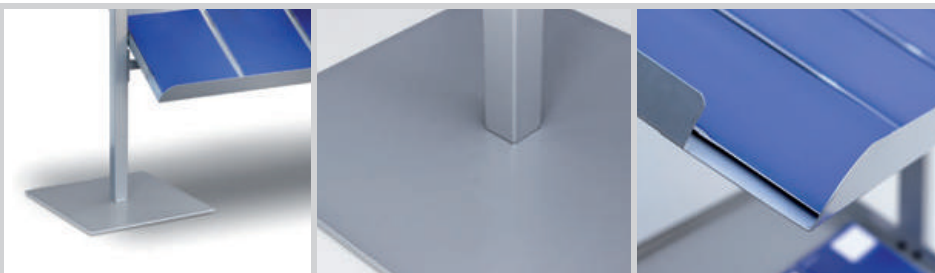
DE Prospektregal aus Metall, in Schwarz oder silver mit drei oder vier frontal ausgerichteten Fächern.



	A	B	C	D	
Ref. 1456R_	147 cm	102 cm	57 cm	40 cm	A4V x 12
Ref. 1457R_	176,5 cm	102 cm	57 cm	40 cm	A4V x 16
01 02 					
Ref. 1456B_	137 cm	131,5 cm	33 cm	40 cm	A4V x 12
Ref. 1457B_	167 cm	131,5 cm	33 cm	40 cm	A4V x 16
01 02 					

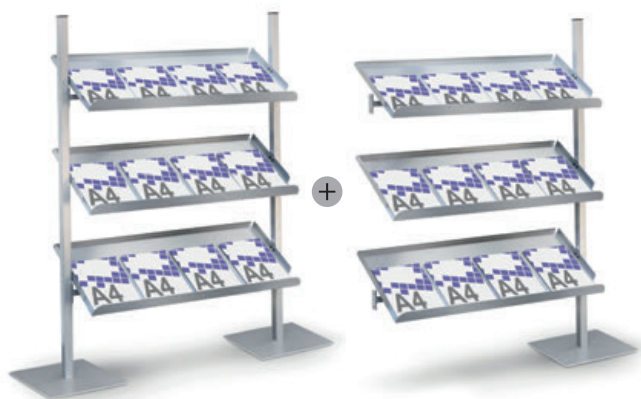
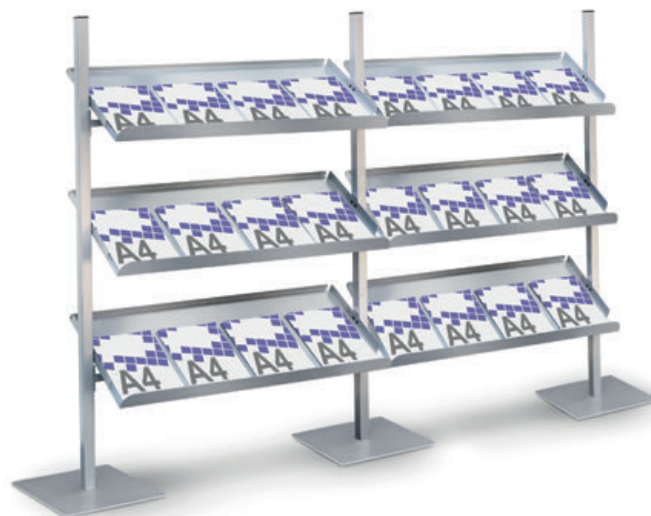
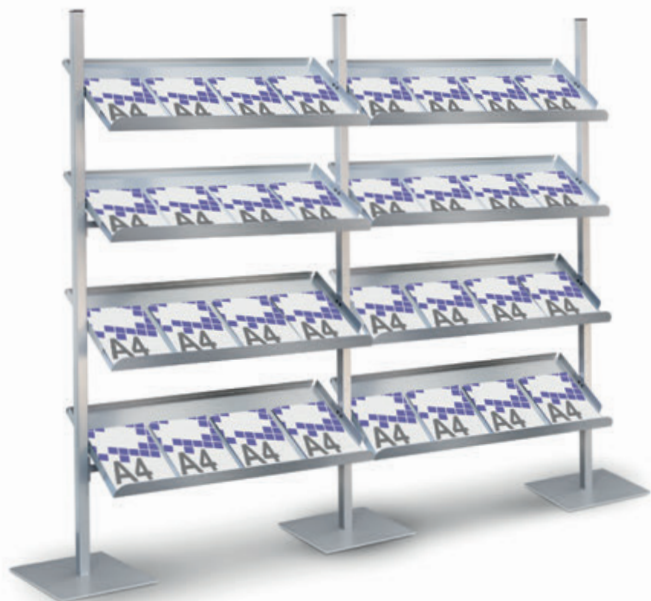

145602L

145602L1

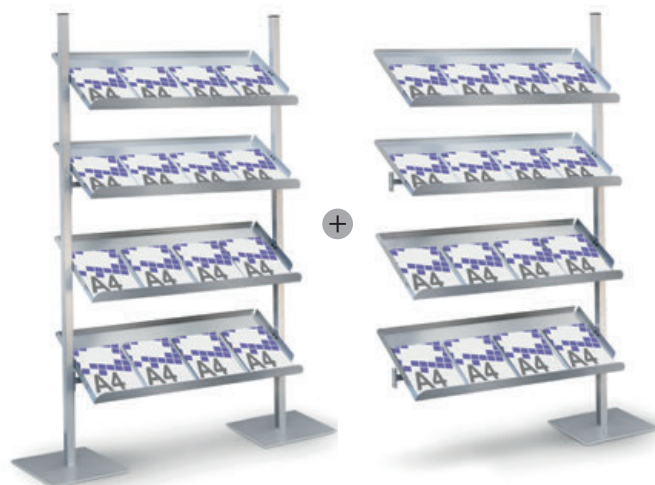

145702L

145702L1

ES Este artículo permite la opción de poder crear montajes con varios expositores.

EN This item has a number of options for assembly to create a variety of displays.

FR Cet article permet de pouvoir créer des montages avec plusieurs présentoirs.

DE Von diesem Artikel kann man mehrere Einheiten miteinander verbinden.

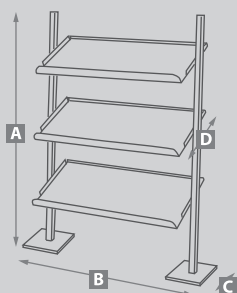

	A	B	C	D	
Ref. 145602L_	147 cm	131,5 cm	33 cm	40 cm	A4V x 12
Ref. 145602L1_	147 cm	117 cm	33 cm	40 cm	A4V x 12
Ref. 145702L_	167 cm	131,5 cm	33 cm	40 cm	A4V x 16
Ref. 145702L1_	167 cm	117 cm	33 cm	40 cm	A4V x 16

01 02



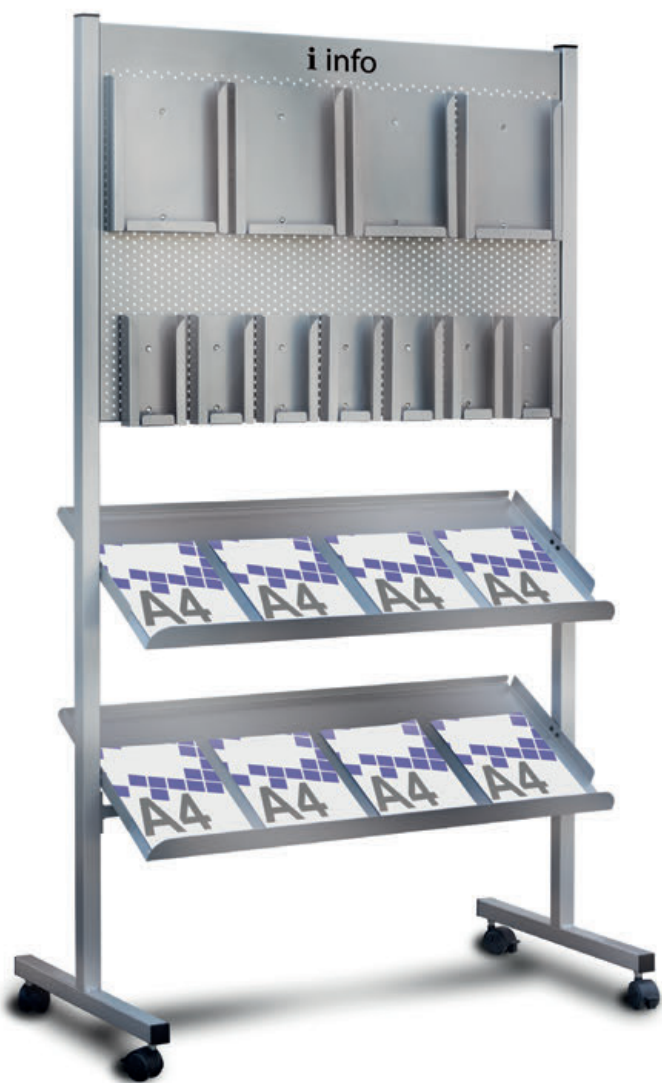

136302 R



136346 R



ES Expositor de pie metálico pintada en color plata, compuesto por un panel fabricado en chapa perforada de 1,5 mm de espesor donde se sitúan porta folletos y dos bandejas para revistas, catálogos etc. Disponible en 2 modelos, 1 modelo con porta folletos metálicos y un modelo con porta folletos de poliestireno.

EN Silver painted portable display stand, consisting of a 1,5mm thick perforated plate where leaflet holders and trays for magazines/catalogues. Available in 2 models, 1 model with metal leaflet holders and 1 model with polystyrene leaflet holders.

FR Présentoir sur pied métallique peint en argent, composé d'un panneau fabriqué en tôle perforée de 1,5 mm. D'épaisseur où l'on peut placer des brochures et deux plateaux pour magazines, catalogues, etc. Disponible en deux modèles, l'un métallique avec porte-brochures et l'autre en polystyrène avec porte-brochures

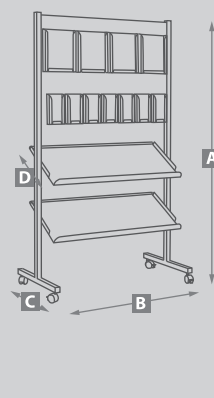
DE Prospektregal mit Fuß aus Metall, Silber lackiert bestehend aus einem perforierten Blech mit einer Stärke von 1,5 mm zur Anbringung von Prospekthalter und zwei Bleche für Zeitschriften, Kataloge, etc. Verfügbar in 2 Modellen, 1 Modell für metallische Prospekthalter und ein Modell mit Prospekthalter aus Polystyren



	A	B	C	D		
Ref. 136302_	184 cm	106,5 cm	57 cm	40 cm	A4V x 12 +	1/3 A4V x 7
Ref. 136346_	184 cm	106,5 cm	57 cm	40 cm	A4V x 8 +	1/3 A4V x 14
	 _R	 _N				
	A	B	C	D		
Ref. 136302B	174,5 cm	136 cm	33 cm	40 cm	A4V x 12 +	1/3 A4V x 7
Ref. 136346B	174,5 cm	136 cm	33 cm	40 cm	A4V x 8 +	1/3 A4V x 14
	 _B					



245902 R

ES Expositor metálico pintado en plata. Paneles fabricados en chapa perforada, donde se sitúan porta folletos DIN A4V, 1/3DIN A4V (formato tríptico) y DIN A5V. Dispone de ruedas con freno, para la movilidad o fijación del artículo. Con posibilidad de incorporar pie nivelador. Paneles muy resistentes fabricados en chapa perforada de 1,5 mm de espesor.

EN Silver painted metal display stand, Perforated metal panels, on which DIN A4V, 1/3DIN A4V (tri-fold size) and DIN A5V leaflet holders are fitted. This item is mounted on casters with brakes so that it can be moved or fixed in one place. With the option of attaching an adjustable levelling foot. Highly resistant panels made of a perforated 1,5 mm thick plate.

FR Présentoir métallique peint en argent. Panneaux fabriqués en plaque perforée où sont situés les porte-brochures DIN A4V, 1/3DIN A4V (format triptyque) et DIN A5V. Équipé de roulettes avec frein, pour la mobilité ou la fixation de l'article. Possibilité d'ajouter des pieds niveleurs. Panneaux très résistants en plaque perforée de 1,5 mm d'épaisseur.

DE Prospektregal aus Metall, in silver. Blende hergestellt aus perforiertem Blech, an der man die Halterungen, DIN A4V, 1/3DIN A4V (Faltprospekte) und DIN A5V, platzieren kann. Ausgestattet mit Rollen und Bremsen für Mobilität oder Fixierung des Artikels. Auch mit höhenverstellbarem Fuß erhältlich. Widerstandsfähige Blende hergestellt aus perforiertem Blech mit 1,5 mm Materialstärke.



245902  x 4  x 3







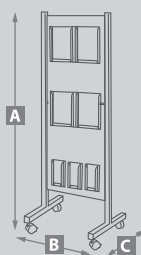

246002  x 2  x 2  x 4



246102  x 9





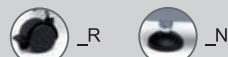



	A	B	C	
Ref. 245902_	180 cm	57 cm	56 cm	 x 4 +  x 3
Ref. 246002_	180 cm	57 cm	56 cm	 x 2 +  x 2 +  x 4
Ref. 246102_	180 cm	57 cm	56 cm	 x 9

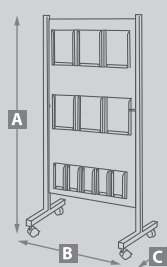



255902 R



	A	B	C	
Ref. 256002_	180 cm	81 cm	56 cm	 x 3 +  x 3 +  x 6
Ref. 255902_	180 cm	81 cm	56 cm	 x 6 +  x 5
Ref. 256102_	180 cm	81 cm	56 cm	 x 15





265902 R

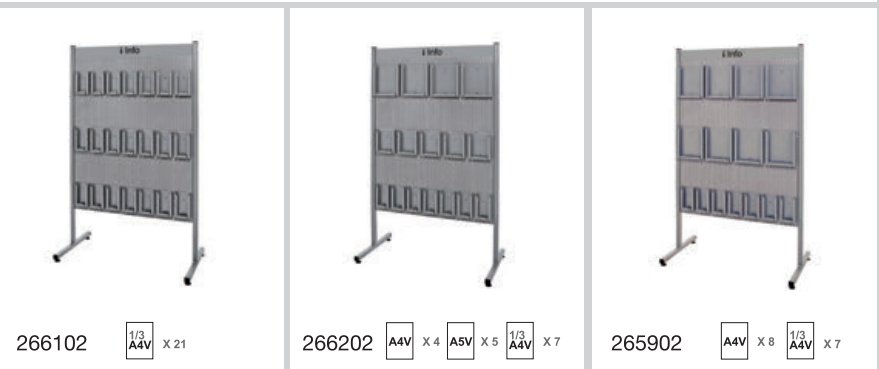
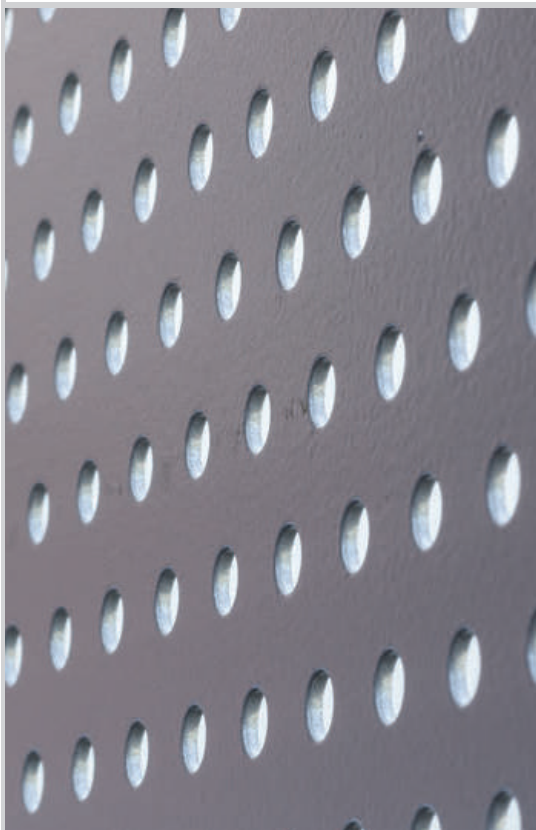





266102  X 21

266202  X 4  X 5  X 7

265902  X 8  X 7



	A	B	C	
Ref. 266102_	180 cm	106 cm	56 cm	 X 21
Ref. 266202_	180 cm	106 cm	56 cm	 X 4 +  X 4 +  X 7
Ref. 265902_	180 cm	106 cm	56 cm	 X 8 +  X 7





266146 R

ES Expositor metálico pintado en plata. Paneles muy resistentes fabricados en chapa perforada de 1,5 mm de espesor, donde se sitúan porta folletos DIN 1/3 A4V(formato tríptico). Porta folletos de poliestireno.

EN Silver painted metal display stand. Highly resistant panels made of a perforated 1.5 mm thick plate, on which 1/3 A4 portrait (tri-fold size) leaflet holders are fitted. Polystyrene leaflet holder.

FR Présentoir métallique peint en argent. Panneaux très résistants en plaque perforée de 1,5 mm d'épaisseur, où sont situés les porte-brochures 1/3DIN A4V (format triptyque). Porte-brochures en polystyrène.

DE Aussteller aus Metall Silber lackiert. Sehr widerstandsfähige Tafeln aus perforiertem Blech hergestellt mit einer Stärke von 1,5 mm, wo Prospekthalter in den Formaten DIN 1/3 A4V angebracht werden (3-teiliges Format).



266146 R  X 28





256146 R  X 20

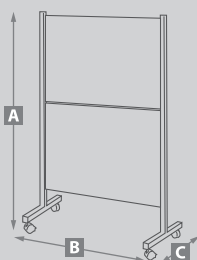

246146 R  X 12



	A	B	C	
Ref. 266146_	180 cm	106 cm	56 cm	 X 28
Ref. 256146_	180 cm	81 cm	56 cm	 X 20
Ref. 246146_	180 cm	57 cm	56 cm	 X 12





185902 R

ES Expositor de pie metálico. Conjunto formado por dos paneles, el panel superior que nos permite la colocación de imanes para la sujeción de papeles, y un panel inferior muy resistente fabricado en chapa perforada de 1,5mm. De espesor, donde se sitúan porta folletos DIN A4V, 1/3DIN A4V (formato tríptico) y DIN A5V. Panel no apto para la escritura.

EN Moveable silver painted metal display stand. Consists of two panels. The upper panel allows the use of magnets to fix papers and a lower panel which is made of strong 1.5mm thick metal plate. Panel not suitable for writing.

FR Présentoir sur pied métallique. Ensemble formé par deux panneaux, le panneau supérieur permet y placer des aimants pour fixer des papiers et un panneau inférieur très résistant fabriqué en tôle perforée de 1,5 mm. où sont situés les porte-brochures DIN A4V, 1/3DIN A4V (format triptyque) et DIN A5V. Panneau pas convenable à écrire.

DE Prospekthalter mit Metallfuß. Diese Einheit wird aus zwei Tafeln gebildet. Die obere Tafel erlaubt das Anbringen von Magnete um Papiere zu fixieren und eine untere Tafel, die sehr belastbar ist. Dieses Lochblech ist mit einer Stärke von 1,5 mm gefertigt, an der man die Halterungen, DIN A4V, 1/3DIN A4V (Faltprospekte) und DIN A5V, platzieren kann. Diese Tafel kann nicht beschriftet werden.



185902  x2 +  x3



186002  x2 +  x4



186102  x6

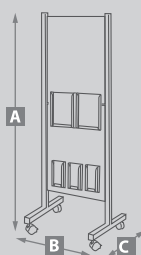

	A	B	C		
Ref. 185902_	180 cm	57 cm	56 cm	 x2 +  x3	
Ref. 186002_	180 cm	57 cm	56 cm	 x2 +  x4	
Ref. 186102_	180 cm	57 cm	56 cm	 x6	





195902 R

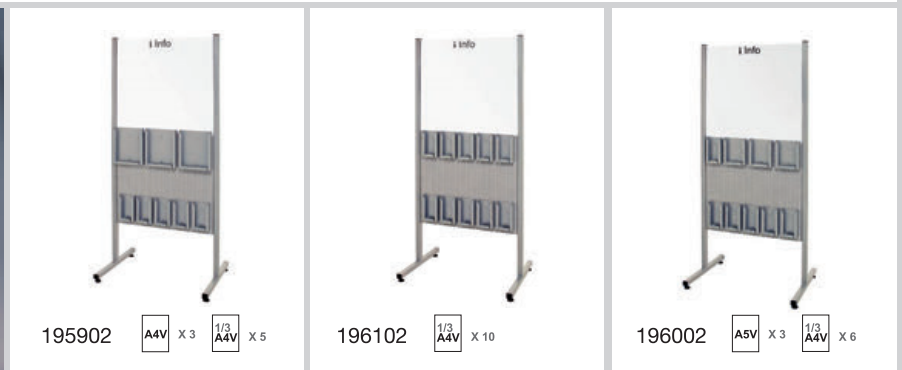



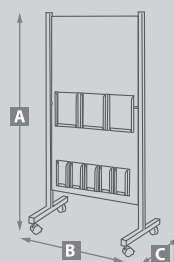

195902  x 3 +  x 5

196102  x 10

196002  x 3 +  x 6



	A	B	C	
Ref. 195902_	180 cm	81 cm	56 cm	 x 3 +  x 5
Ref. 196102_	180 cm	81 cm	56 cm	 x 10
Ref. 196002_	180 cm	81 cm	56 cm	 x 3 +  x 6

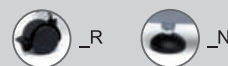



205902 R

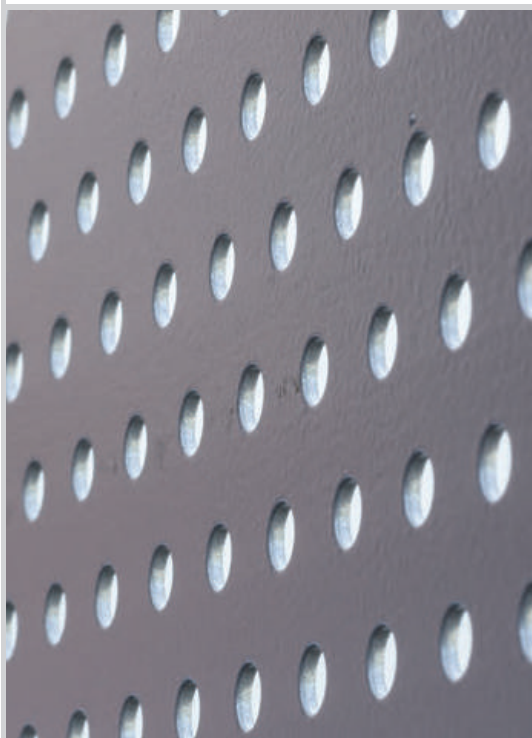

205902  x 4 +  x 7







206102  x 14

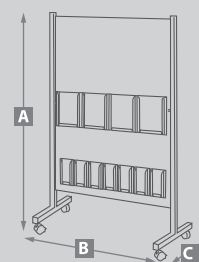

206002  x 5 +  x 7



	A	B	C	
Ref. 205902_	180 cm	106 cm	56 cm	 x 4 +  x 7
Ref. 206102_	180 cm	106 cm	56 cm	 x 14
Ref. 206002_	180 cm	106 cm	56 cm	 x 5 +  x 7



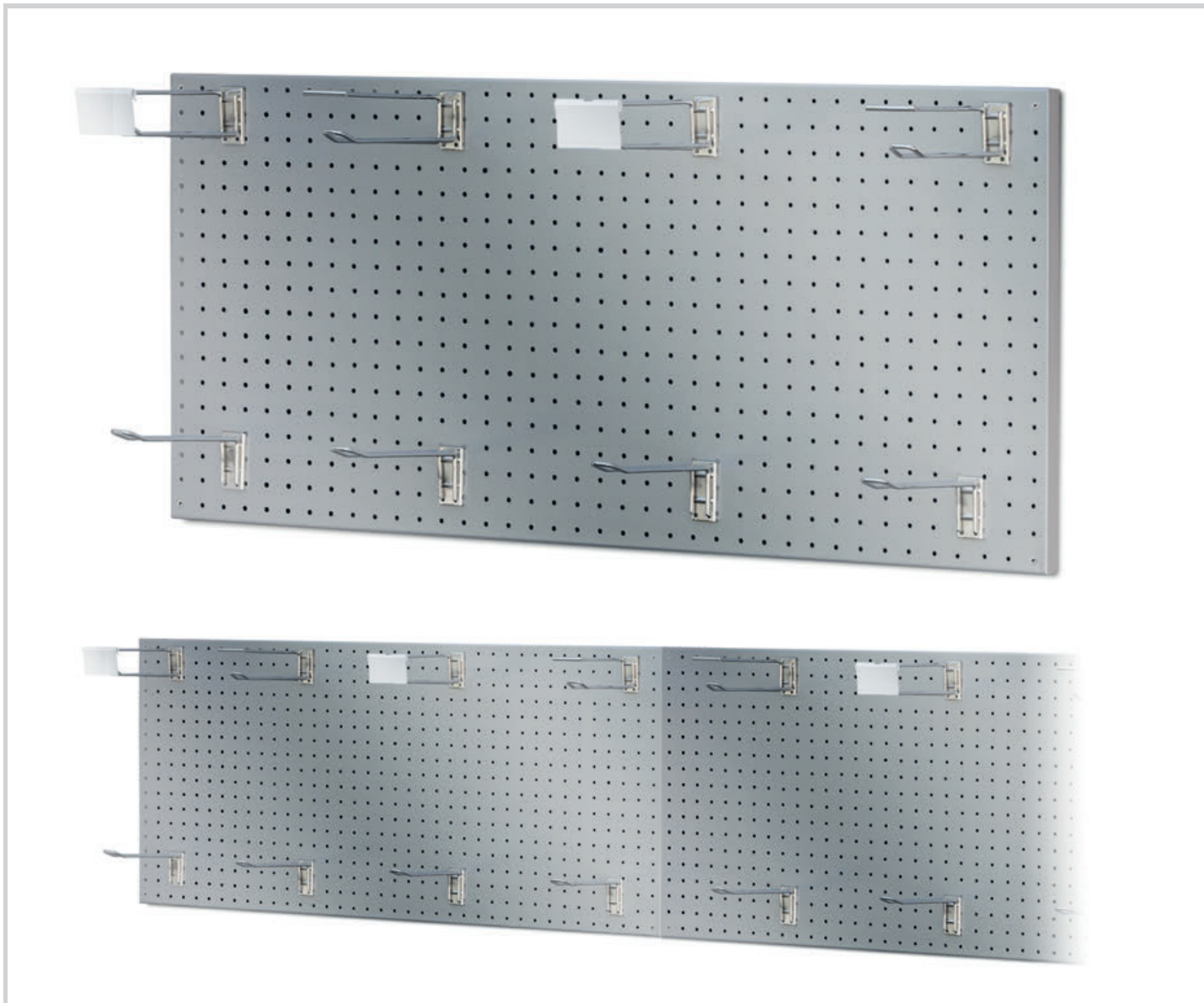

ES Panel perforado para fijación mural, fabricado en chapa perforada de 1,5 mm de espesor, donde podemos situar diferentes modelos de ganchos cromados de varilla de 5 y 6 mm. El panel perforado se entrega sin ganchos, puede elegir entre los diferentes modelos de ganchos en la página 37.

EN Perforated wall panel made of perforated 1.5 mm thick plate, where we can put different models of chrome hooks of 5 and 6 mm. The perforated wall-mounted display stand is supplied without hooks. Different models of hooks can be found on page 37.

FR Panneau perforé mural, fabriqué en plaque perforée de 1,5 mm. D'épaisseur, où nous pouvons situer différents modèles de crochets en chrome de 5 et 6 mm. Le panneau perforé est livré sans crochets, on peut choisir les différents modèles de crochets sur la pag. 37.

DE Perforiertes Blech welches als Wandhalterung dient, hergestellt aus perforiertem Blech mit 1,5mm Materialstärke, an welcher man verschiedene Modelle chromfärbiger Haken von 5 und 6 mm anbringen kann. Die Lochtafel wird ohne Haken geliefert. Sie können unter den verschiedenen Hakenmodellen auf Seite 37 wählen.

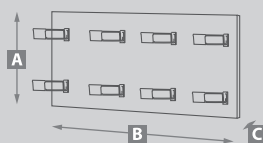

Ref. **650102** **A** 45,5 cm **B** 95,5 cm **C** 3 cm



640102 R



ES Expositor de pie, provisto de 3 paneles muy resistentes fabricados en chapa perforada de 1,5 mm de espesor, donde podemos situar diferentes modelos de ganchos cromados de varilla de 5 y 6 mm. El panel perforado se entrega sin ganchos, puede elegir entre los diferentes modelos de ganchos en la página 37.

EN Free standing display stand, with three highly resistant panels made of perforated 1,5 mm thick plate, where we can place different models of chrome hooks of 5 and 6 mm. The perforated wall-mounted display stand is supplied without hooks. Different models of hooks can be found on page 37.

FR Présentoir sur pied, équipé de 3 panneaux très résistants en plaque perforée 1,5 mm d'épaisseur, où nous pouvons placer différents modèles de crochets fabriqués avec des tiges en chrome de 5 et 6 mm. Le panneau perforé est livré sans crochets, on peut choisir les différents modèles de crochets sur la pag. 37.

DE Prospekthalterständer, mit 3 widerstandsfähigen Blenden hergestellt aus perforiertem Blech mit 1,5 mm Materialstärke, an welche man verschiedene Modelle aus chromfärbiges Haken von 5 und 6 mm anbringen kann. Die Lochtafel wird ohne Haken geliefert. Sie können unter den verschiedenen Hakenmodellen auf Seite 37 wählen.

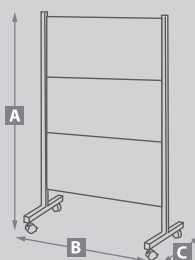
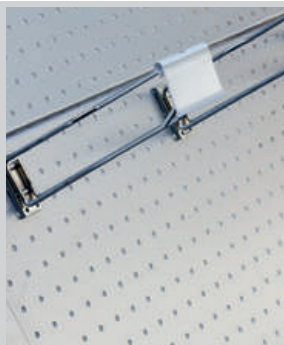

	A	B	C
Ref. 640102_	183,5 cm	103 cm	55,5 cm



_R



_N

	A	B	C
Ref. 640102B	174,5 cm	132,5 cm	33 cm



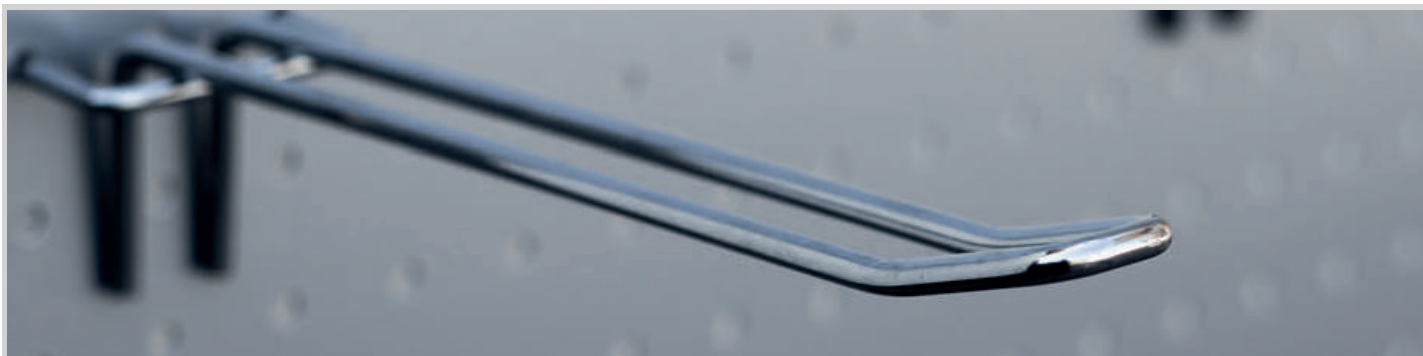

7810



7910



6610



6710



7610



7710



6810



6910



7911

ES Diferentes modelos de ganchos cromados, para ser situados en el expositor de pie i en el panel perforado de pared. También se pueden suministrar en acabado cincado bajo pedido.

EN Various models of Chrome finished hooks to insert into portable perforated display stands and perforated wall mounted display stands. Can also be supplied in galvanised steel on request.

FR Différents modèles de crochets chromés, pour être situés sur le présentoir sur pied et sur le panneau perforé mural. On peut aussi les livrer galvanisés sous commande.

DE Verschiedene verchromte Hakenmodelle um im Standprospekthalter sowie an der Wandlochttafel verwendet zu werden.

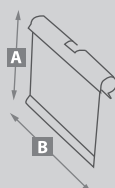
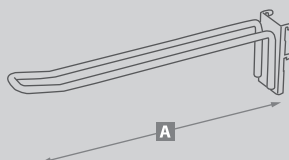

	A	A1	A2	A3	A4	Ø
Ref. 6610	20 cm	25 cm	30 cm	35 cm	—	6 mm
Ref. 6710	20 cm	25 cm	30 cm	35 cm	—	6 mm
Ref. 6810	20 cm	25 cm	30 cm	35 cm	—	6 mm
Ref. 6910	20 cm	25 cm	30 cm	35 cm	—	6 mm
Ref. 7610	15 cm	20 cm	25 cm	30 cm	35 cm	5 mm
Ref. 7710	20 cm	25 cm	30 cm	—	—	5 mm
Ref. 7810	20 cm	25 cm	30 cm	—	—	5 mm
Ref. 7910	20 cm	25 cm	30 cm	—	—	5 mm

	A	B
Ref. 7911	4 cm	6,5 cm



11129F 03



11128 03

ES Expositor de pared fabricado con varilla de 0,5 cm. pintada en color negro, plata y blanco. Producto ideal para exponer diarios y revistas, formatos Din A4 vertical i Din A3 vertical. Disponible en 5 y 10 departamentos.

EN Wall showcase made with 0,5cm thick bars. Painted in black, silver and white. Perfect item for exhibiting journals and magazines, formats DIN A4 vertical and DIN A3 vertical. Available in five and ten units.

FR Présentoir mural fabriqué en tige de 0,5 cm. peint en noir, argent et blanc. Produit idéal pour exposer les journaux et revues, formats Din A4 vertical et Din A3 vertical. Disponible en 5 et 10 compartiments.

DE Wandprospektregal mit Rundeseisen in 0,5 cm hergestellt, in Schwarz, Silber und Weiß lackiert. Geeignet um Zeitschriften, Format DIN A4, frontal und DIN A3 vertikal, auszustellen. Mit 5 oder 10 Fächern lieferbar.

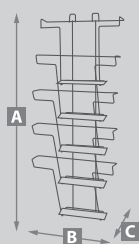

	A	B	C	
Ref. 11128F_	80 cm	23 cm	14,5 cm	A4V x 5
Ref. 11129F_	144 cm	23 cm	14,5 cm	A4V x 10
Ref. 11128_	81,5 cm	34,5 cm	15,5 cm	A3V x 5
Ref. 11129_	147,5 cm	34,5 cm	15,5 cm	A3V x 10

01 02 03



ES Expositor con paneles de malla, fabricados con varilla metálica, de un diámetro exterior de 0,6 cm. e interior de 0,4 cm. y una distancia entre varillas de 5 cm. Panel donde se pueden situar varios accesorios como bandejas rectas, bandejas inclinadas y ganchos. Este producto permite montar expositores de pie con uno o varios paneles o bien ser fijado directamente a la pared.

EN Display stand with panels made of wire net made of metal rods, with an exterior diameter of 0,6 cm and an interior diameter of 0,4cm and a gap between the rods of 5 cm. Panel where you can place different accessories like straight and inclined trays and hooks. This product allows you to set up floor stands with one or various panels or to attach it directly to a wall.

FR Présentoir avec des panneaux en treillis, fabriqués en tige métallique, d'un diamètre extérieur de 0,6 cm. et intérieur de 0,4 cm. et d'une distance de 5 cm entre les tiges. Panneau où l'on peut placer différents accessoires tels que des plateaux plats, des plateaux inclinés et crochets. Ce produit permet de monter des présentoirs sur pied avec un ou plusieurs panneaux ou être fixés directement au mur.

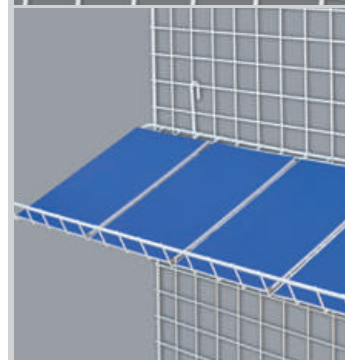
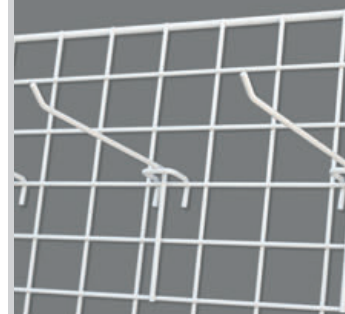
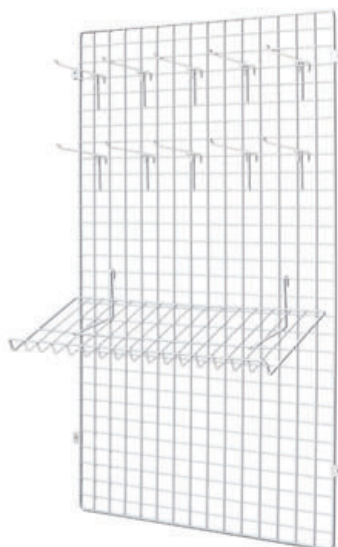

DE Prospekthalter mit Blech aus Gitter, aus Metallstäben von 0,6cm Außendurchmesser und 0,4cm Innendurchmesser zusammengesetzt, Abstand zwischen Stangen 5 cm. Wandplatte um verschiedenen Zubehör wie frontale Fächer, geneigte Fächer und Haken anzubringen. Mit höhenverstellbaren Fuß erhältlich mit einer oder verschiedenen Wandplatten oder um den Artikel direkt an der Wand zu fixieren.

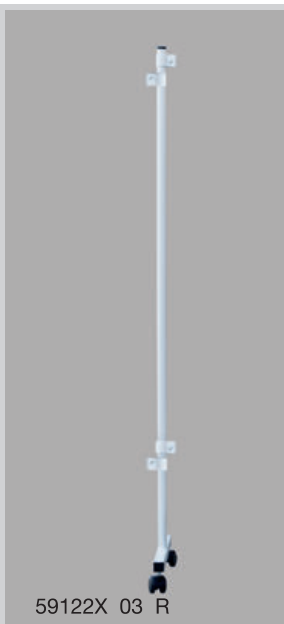
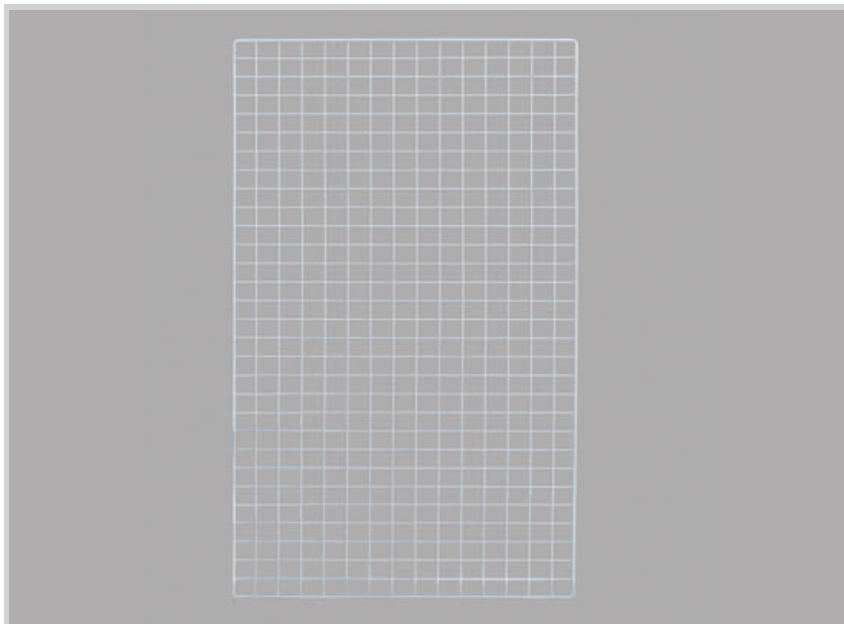



	A	B	C
Ref. 59121-1_	90 cm	30 cm	1 cm
Ref. 59121-2_	90 cm	60 cm	1 cm
Ref. 59121-3_	90 cm	90 cm	1 cm
Ref. 59121-4_	150 cm	30 cm	1 cm
Ref. 59121-5_	150 cm	60 cm	1 cm

	A	B	C
Ref. 59121-6_	150 cm	90 cm	1 cm
Ref. 59121-7_	180 cm	30 cm	1 cm
Ref. 59121-8_	180 cm	60 cm	1 cm
Ref. 59121-9_	180 cm	90 cm	1 cm

	A	B	C	
Ref. 59122_ _	160 cm	3 cm	51,1 cm	 X2
Ref. 59122X_ _	160 cm	3 cm	51,1 cm	 X4

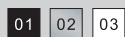

Gancho Simple
Simple hook
Crochet simple
Einfacher Haken



Gancho Doble
Double hook
Crochet double
Doppel Haken



Gancho Doble soporte etiqueta
Double hook with label holder
Crochet double support plaque
Doppel Haken Etikettenhalter



Placa fijación pared
Plate to attach to a wall
Plaque support mural
Haltplatte



Conector tubo y malla
Connection piece tube to wire net
Connecteur entre tuyau et treillis
Rohr und Masche Verbinder

Ref.	B	∅
59123_	20 cm	5 mm
59123/2_	25 cm	5 mm

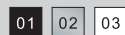

Ref.	B	∅
59123D_	20 cm	5 mm
59123D1_	25 cm	5 mm

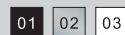

Ref.	B	∅
59123E_	20 cm	5 mm
59123E1_	25 cm	5 mm

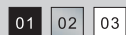

Ref. 59125_	  
-------------	--

Ref. 59127_	  
-------------	---

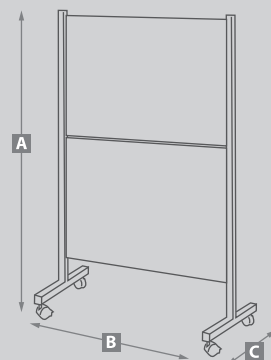

Conector malla y malla
Connection piece wire net to wire net
Connecteur entre treillis
Masche Verbinder

Ref. 59126_	  
-------------	---



Portaprecios
Price Holders
Porte-prix
Preishalter

Ref. 7911	A	B
	4 cm	6,5 mm

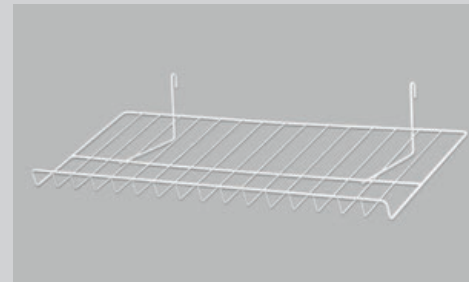

	A	B	C
Ref. 59124_	5 cm	88 cm	33,5 cm

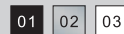



388002



388102

ES Sistema de exposición a través de cables tensores. Producto ideal para todo tipo de escaparates, inmobiliarias, tiendas, oficinas, agencias etc.

EN Exhibition system using cable tensors. An ideal product for all types of window display, estate agents, shops, offices and travel agents.

FR Système d'exposition grâce a des haubans. Produit idéal pour toutes sortes de vitrines, agences immobilières, commerces, bureaux, agences etc

DE Ausstellungssystem mittels Seilsystem. Es handelt sich hierbei um ein ideales Produkt für alle Arten von Schaufenster, Immobilien, Läden, Büros, Agenturen, etc.

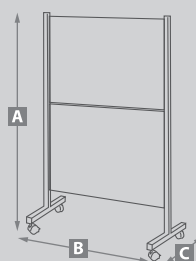

	A	B	C	
Ref. 388002	211 cm	123 cm	56 cm	A4V X 20
Ref. 388102	211 cm	176 cm	56 cm	A4V X 30

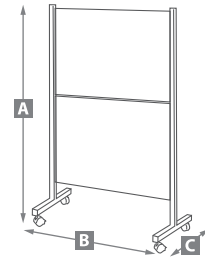

Ref. 388002L

A 211 cm **B** 123 cm **C** 56 cm



Ref. 388002L1

A 211 cm **B** 119,5 cm **C** 56 cm



Ref. 388102L

A 211 cm **B** 176 cm **C** 56 cm



Ref. 388102L1

A 211 cm **B** 172,5 cm **C** 56 cm



Ref. 388002E

A 211 cm **B** 123 cm **C** 56 cm



Ref. 388002E1

A 211 cm **B** 119,5 cm **C** 56 cm



Ref. 388102E

A 211 cm **B** 176 cm **C** 56 cm



Ref. 388102E1

A 211 cm **B** 172,5 cm **C** 56 cm



Ref. T104



Ref. P106



Ref. P107



Ref. C111 **A4V**

Ref. C112 **A4H**

Ref. C113 **A3V**

Ref. C114 **A3H**



276202R



276302R



ES Mamparas metálicas pintadas en color plata. Paneles muy resistentes fabricados en chapa perforada de 1,5 mm de espesor. Varias posibilidades de montaje, para crear diferentes separaciones de espacios, según de desee.

EN Silver painted metal partition screens. Highly resistant panels made of a perforated 1,5 mm thick plate. A range of options for assembly to create different ways to divide up spaces, depending on your needs.

FR Totems métalliques peints en argent. Panneaux très résistants en plaque perforée de 1,5 mm d'épaisseur. Plusieurs possibilités de montage pour créer différents séparations d'espace, selon vos souhaits.

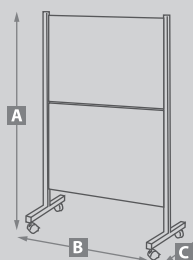
DE Ausstellungswände aus Metall in Silber. Widerstandsfähige Blende hergestellt aus perforiertem Blech mit 1,5 mm Materialstärke. Verschiedene Möglichkeiten für den Aufbau um, je nach Wunsch, verschiedenste Platzaufteilungen zu kreieren.



	A	B	C
 Ref. 276202R	143,5 cm	105,5 cm	56 cm
Ref. 276302R	204 cm	105,5 cm	56 cm
	A	B	C
 Ref. 276202B	133,5cm	134,5 cm	33 cm
Ref. 276302B	194,5 cm	134,5 cm	33 cm



281402 R



281400 R

ES Mampara expositor metálica, formada por uno o dos paneles de alta resistencia fabricados en chapa perforada de 1,5 mm. de espesor, más un panel metálico, provisto de 6 bandejas para la exposición de todo tipos de documentos.

EN Metal partition screen, made of one or two highly resistant panels made of perforated 1,5 mm thick plate. Plus a metal panel, consisting of six shelves for exhibiting all kinds of documents.

FR Totem présentoir en métal, constitué d'un ou deux panneaux de haute résistance en plaque perforée en 1,5 mm.d'épaisseur, plus un panneau métallique, équipé de 6 plateaux pour exposer tous types de documents.

DE Ausstellungswand aus Metall, mit einer oder zwei hochwertigen Blenden hergestellt aus perforiertem Blech mit 1,5 mm Materialstärke zuzüglich einer Blende aus Metall mit 6 Ablagen um verschiedenste Unterlagen zu platzieren.

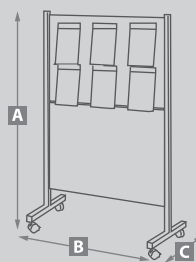
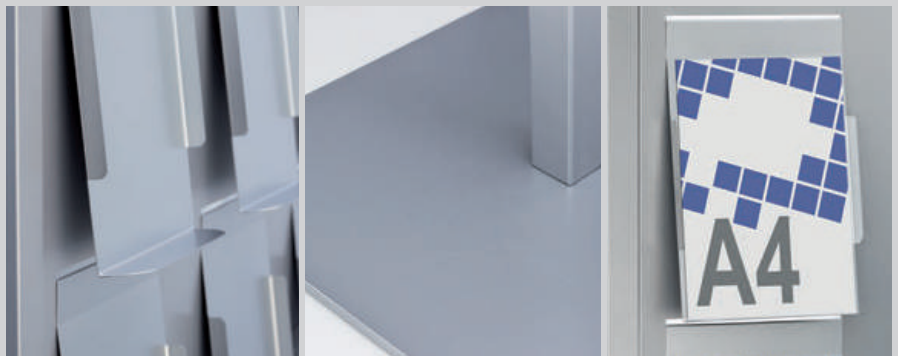

		A	B	C	
	Ref. 281400R	143,5 cm	105,5 cm	56 cm	A4V X 6
	Ref. 281402R	204 cm	105,5 cm	56 cm	A4V X 6
		A	B	C	
	Ref. 281400B	133,5cm	134,5 cm	33 cm	A4V X 6
	Ref. 281402B	194,5 cm	134,5 cm	33 cm	A4V X 6



281400ER



281402ER

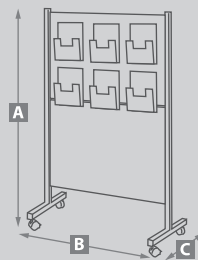

	A	B	C	
Ref. 281400ER	143,5 cm	105,5 cm	56 cm	A4V x 6
Ref. 281402ER	204 cm	105,5 cm	56 cm	A4V x 6
Ref. 281400EB	133,5cm	134,5 cm	33 cm	A4V x 6
Ref. 281402EB	194,5 cm	134,5 cm	33 cm	A4V x 6



ES Mampara metálica pintada en color plata, conjunto formado por paneles de alta resistencia, fabricados en chapa perforada de 1,5 mm de espesor y panel expositor provisto de 6 bandejas. Producto que nos permite varias posibilidades de montaje para crear diferentes separaciones de espacios, permitiendo combinar paneles perforados y paneles con estantes, para exponer todo tipo de documentos.

EN Metal screen painted in silver, consisting of highly resistant panels made of perforated, 1,5 mm thick plates and a showcase panel with six shelves. The item gives us lots of options for setting it up to create different separated spaces by combining the perforated panels and the panels with shelves to exhibit all kinds of documents.

FR Totem métallique peint en argent, ensemble formé par des panneaux de haute résistance, en plaque perforée 1,5 mm d'épaisseur et muni d'un panneau à 6 plateaux. Produit qui permet multiples options de montage pour créer des différentes partitions des espaces, permettant combiner des panneaux perforés et des panneaux avec des étagères, pour exposer toutes sortes de documents.

DE Ausstellungswände aus Metall in Silber, aus hochwertiger Blende hergestellt aus perforiertem Blech mit 1,5mm Materialstärke und einer Blende aus Metall mit 6 Ablagen. Dieses Produkt erlaubt verschiedene Aufbaumöglichkeiten um verschiedenen Räume zu schaffen. Man kann perforiertes Blech und Regale kombinieren um verschiedenste Arten von Unterlagen zu platzieren.

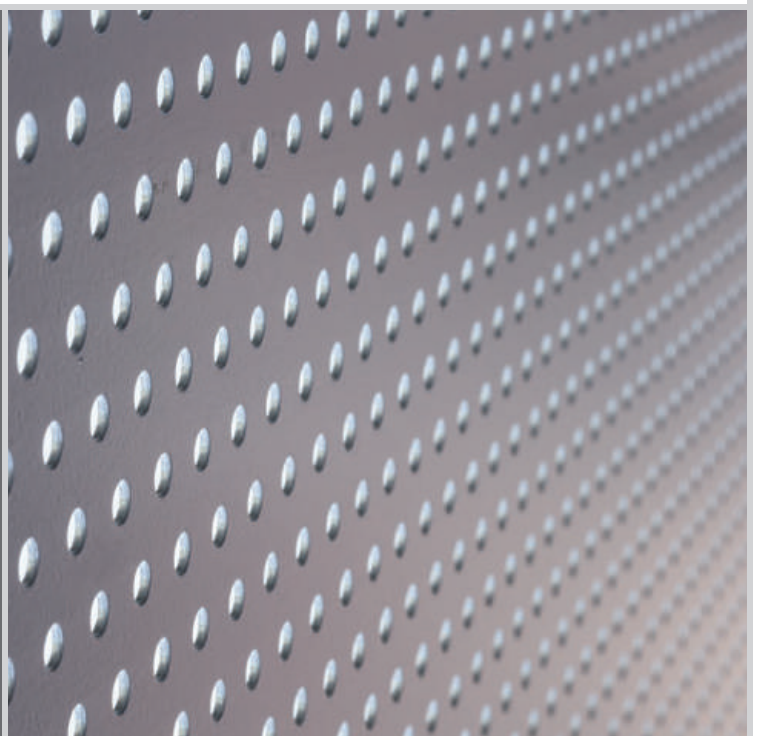

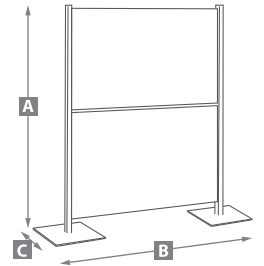
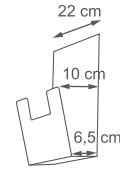
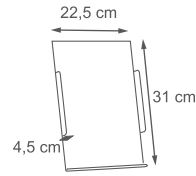

Ref. 281402L

A **B** **C**
194,5 cm 134,5 cm 33 cm **A4V** x 6



Ref. 281402L1

A **B** **C**
194,5 cm 115,5 cm 33 cm **A4V** x 6



Ref. 281400L

A **B** **C**
133,5 cm 134,5 cm 33 cm **A4V** x 6



Ref. 281400L1

A **B** **C**
133,5 cm 115,5 cm 33 cm **A4V** x 6



Ref. 281402E

A **B** **C**
194,5 cm 134,5 cm 33 cm **A4V** x 6



Ref. 281402E1

A **B** **C**
194,5 cm 115,5 cm 33 cm **A4V** x 6



Ref. 281400E

A **B** **C**
133,5 cm 134,5 cm 33 cm **A4V** x 6



Ref. 281400E1

A **B** **C**
133,5 cm 115,5 cm 33 cm **A4V** x 6



Ref. 276302L

A **B** **C**
194,5 cm 134,5 cm 33 cm



Ref. 276302L1

A **B** **C**
194,5 cm 115,5 cm 33 cm



Ref. 276202L

A **B** **C**
133,5 cm 134,5 cm 33 cm



Ref. 276202L1

A **B** **C**
133,5 cm 115,5 cm 33 cm



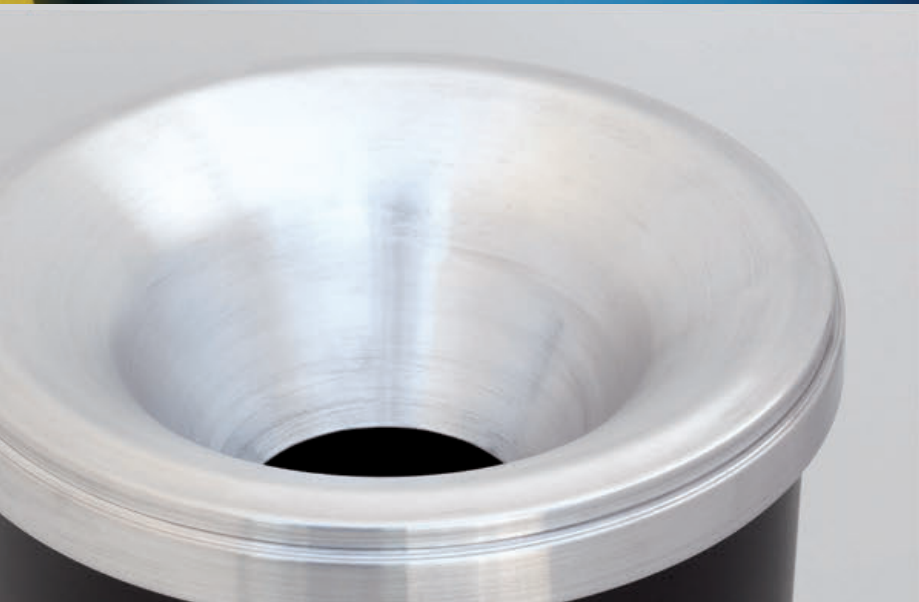

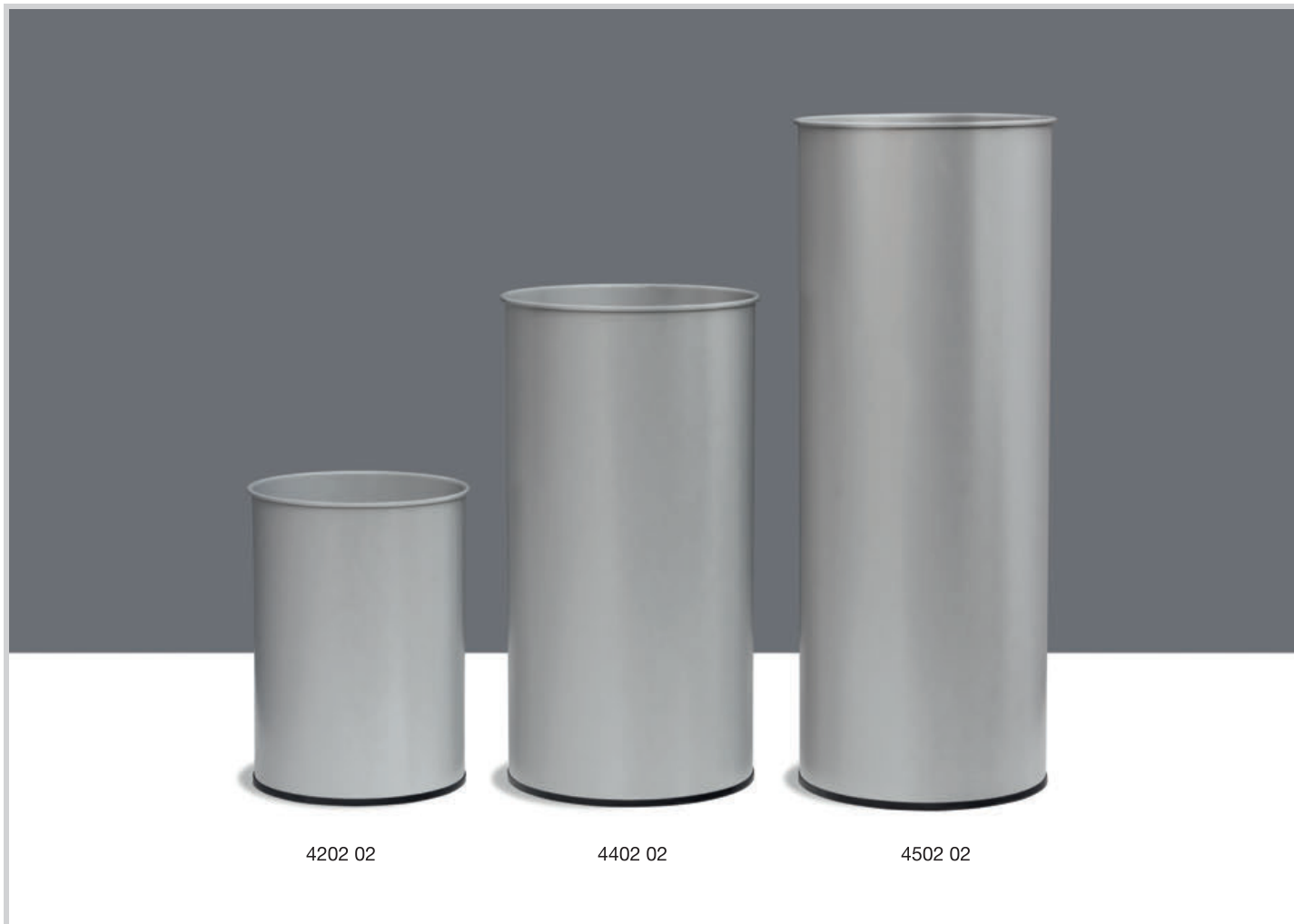

4202 02

4402 02

4502 02



ES Colección de papeleras fabricadas en metal, pintadas con pintura epoxi y bordón de plástico anticorrosión en la base. Disponible en 3 formatos:
Papelera con aro protector en la base, con tapa superior o con tapa superior y base en acero inoxidable.

EN Collection of metal wastepaper baskets, painted with epoxy paint and anticorrosive plastic on the base. Available in three options: wastepaper basket with protective ring on the base, with lid or with lid and stainless steel base.

FR Collection De corbeilles à papier fabriquées en métal, peintes avec peinture epoxi et cercle protecteur en plastique anticorrosion sur la base. Disponible en trois formats:
Corbeille avec cercle protecteur sur la base, avec couvercle supérieure ou couvercle supérieure et base en acier inoxydable.

DE Papiereimersammlung aus Metall gefertigt, angemalt mit Epoxi-Farbe und Rostschutzplastiknaht an der Unterseite. In drei Größen lieferbar:
Papiereimer mit Schutzring an der Unterseite, mit Klappe oder mit Klappe und Unterseite aus Edelstahl.



Ref. 4202_ **A** 32 cm **B** 26 cm

16L 01 02 03 19 23 24 25



Ref. 4402_ **A** 50 cm **B** 26 cm

25L 01 02 03 19 23 24 25



Ref. 4502_ **A** 67 cm **B** 26 cm

35L 01 02 03 19 23 24 25



Ref. 4602_ **A** 32,5 cm **B** 26 cm

16L 01 02 03 19 23 24 25



Ref. 4702_ **A** 50,5 cm **B** 26 cm

25L 01 02 03 19 23 24 25



Ref. 4802_ **A** 67,5 cm **B** 26 cm

35L 01 02 03 19 23 24 25



Ref. 4902_ **A** 35 cm **B** 26 cm

16L 01 02 03 19 23 24 25



Ref. 5002_ **A** 53 cm **B** 26 cm

25L 01 02 03 19 23 24 25



Ref. 5102_ **A** 70 cm **B** 26 cm

35L 01 02 03 19 23 24 25



Ref. 4002_ **A** 32 cm **B** 21,5 cm

12L 01 02



Ref. 4102_ **A** 32 cm **B** 23 cm

14L 01 02

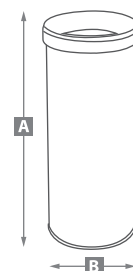



43119

ES Carrito móvil de estructura metálica. Dispone de ruedas con freno. Papelera con aro protector y tapa superior.

EN Moveable trolley with metal frame, mounted on casters with brakes. Wastepaper basket with protective ring and lid.

FR Chariot mobile, structure métallique. Dispose de roulettes avec frein. Corbeille à papier avec cercle protecteur et couvercle supérieur.

DE Wagen mit Metallrahmen. Enthält Rollen mit Bremsen. Papierkorb mit Gummiunterseite und Deckel.

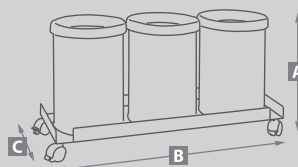

	A	B	C	
Ref. 43117	38,5 cm	80 cm	27 cm	16 L x 3
Ref. 43118	56,5 cm	80 cm	27 cm	25 L x 3
Ref. 43119	73,5 cm	80 cm	27 cm	35 L x 3



480247 02



470247 01

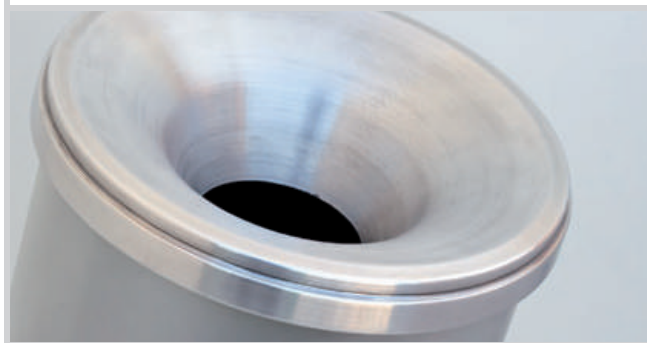

430049 01

430048 50

ES Papeleras ignífugas, depósito metálico pintado color plata y tapa fabricada en aluminio, disponible en 16, 25 y 35 litros. La forma de la tapa consigue interrumpir la entrada de oxígeno en el interior de la papeleras favoreciendo la extinción de las llamas.
Papeleras rectangular ignífuga, fabricada con fibra de vidrio, disponible en 14 y 8 litros.
Colores marrón y negro.

EN Flame-resistant bins, metal deposit painted in silver and cover made of aluminium, available in 16, 25 and 35 litres. The form of the cover prevents oxygen from getting in the interior of the bin thus assisting the extinguishing of flames.
Rectangular flame-resistant bin, made of fibreglass, available in 14 and 8 litres. Colours brown and black.

FR Corbeilles à papier ignifuges, dépôt métallique couleur argent et couvercle en aluminium, disponibles en 16, 25 et 35 litres. La forme du couvercle permet d'interrompre l'entrée d'oxygène à l'intérieur de la poubelle en favorisant l'extinction des flammes.
Corbeille à papier rectangulaire, fabriquée en fibre de verre, disponible en 14 et 8 litres.
Brun et noir.

DE Feuerfester Abfalleimer, Behälter aus Metall, in Silber lackiert, Deckel aus Aluminium hergestellt, in 16, 25 und 35 Liter lieferbar. Die Form des Deckels verhindert das Eindringen von Sauerstoff in den Innenraum und beugt so der Flammentwicklung vor.
Feuerfester Abfalleimer mit rechteckiger Form, aus Glasfaser hergestellt, in 14 und 18 Liter lieferbar. In braun und schwarz.

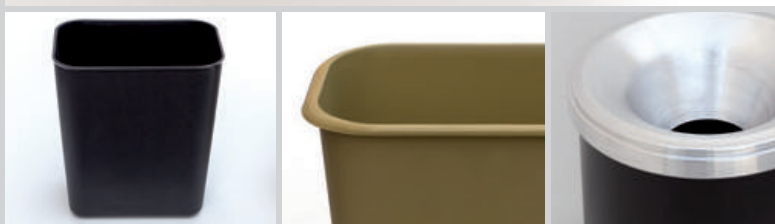

	A	B		
Ref. 460247_	32,5 cm	26 cm	16L	
Ref. 470247_	50,5 cm	26 cm	25L	
Ref. 480247_	67,5 cm	26 cm	35L	
01 02				
	A	B	C	
Ref. 430048_	31,5 cm	29,5 cm	20,5 cm	14L
Ref. 430049_	26,5 cm	23,5 cm	16,5 cm	8L
01 50				

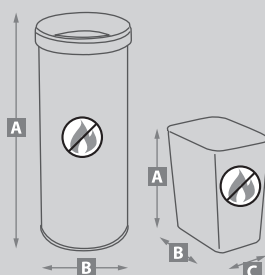

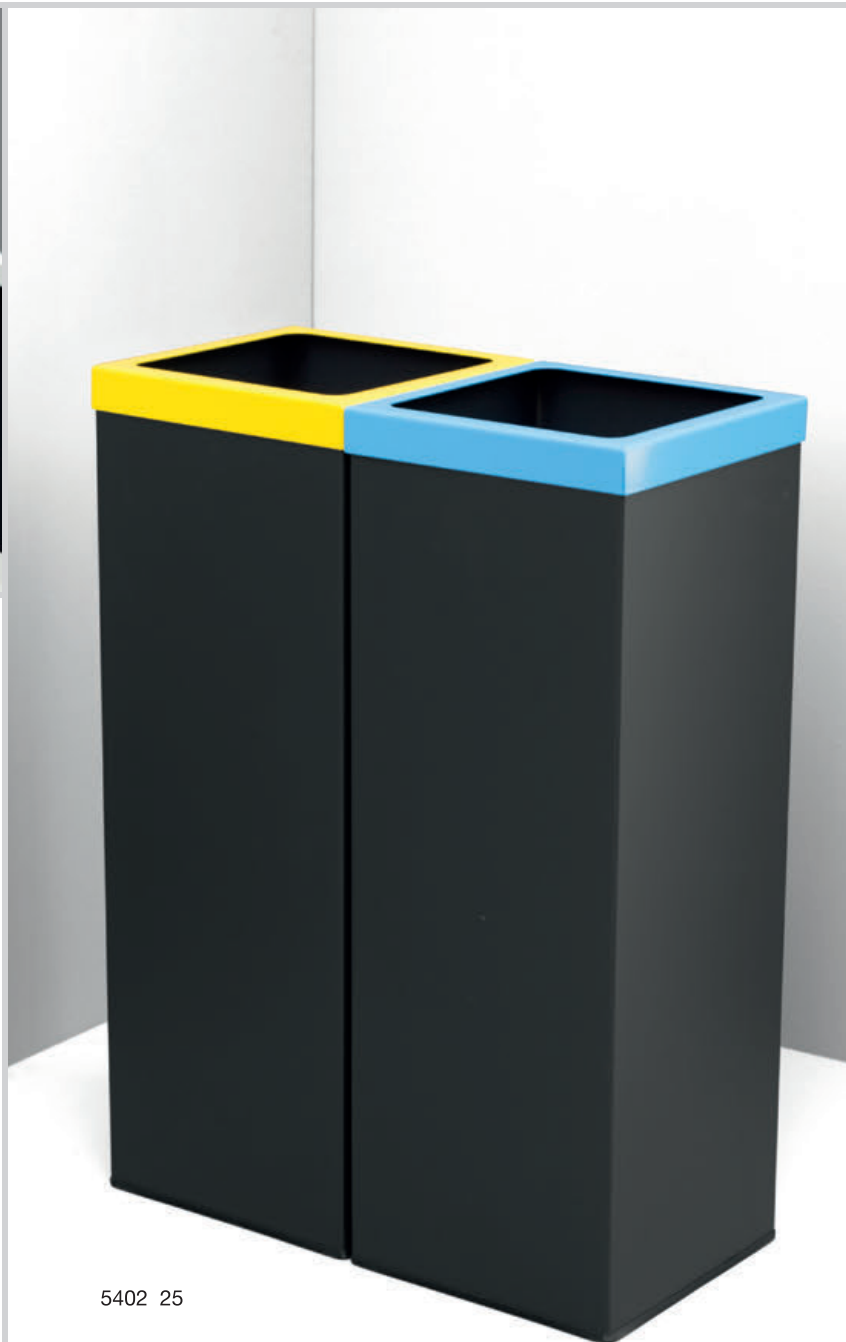
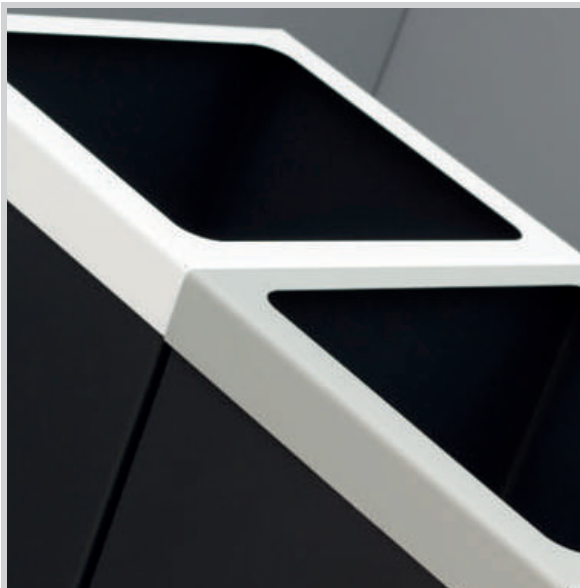

5402 25

5402 23



5402 23

ES Papelera metálica para reciclaje pintada en color grafito texturado. Tapa disponible en 6 colores.

EN Recycling bin painted in textured graphite color. Top available in 6 colors.

FR Corbeille à papier de recyclage métallique peint en graphite texture. Le couvercle est disponible en 6 couleurs.

DE Recyclingpapierkorb in texturierte Graphit. Deckel erhältlich in 6 Farben.

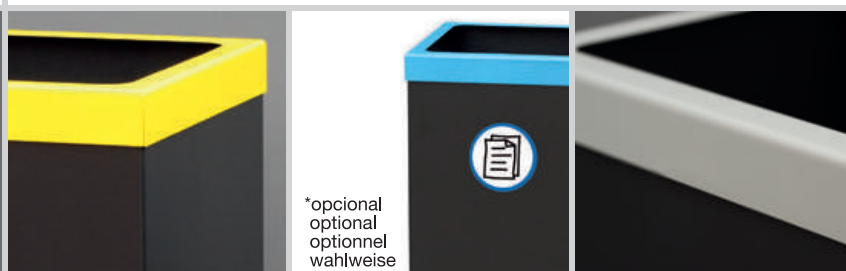

*opcional
optional
optionnel
wahlweise

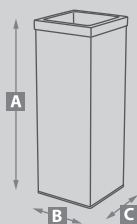

Ref.	A	B	C	Capacity	
5402_	71 cm	25 cm	25 cm	44 L	
02	03	19	23	24	25



5302 25

5302 24

ES Papelera metálica para reciclaje pintada en color grafito texturado, tapa superior abatible y aro interior para sujeción de bolsa. Tapa disponible en 4 colores, verde, azul, marrón y amarillo.

EN Recycling bin painted in textured graphite colour, lid swing top and inner ring for fastening bag. Top available in 4 colors, green, blue, Brown and yellow.

FR Corbeille à papier de recyclage métallique peint en graphite texturé, couvercle à charnière et bague intérieure pour fixer le sacs poubelles. Le couvercle est disponible en 4 couleurs, vert, bleu, brun et jaune.

DE Recyclingpapierkorb in texturierte Graphit, Deckel Swing Top und innerer Ring zur Befestigung der Tasche. Deckel erhältlich in 4 Farben, grün, blau, braun und gelb.

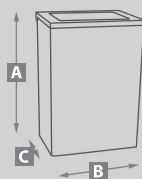

	A	B	C	
Ref. 5202_	80,5 cm	36 cm	26,5 cm	76 L
Ref. 5303_	81 cm	39,5 cm	28,5 cm	91 L
	19	23	24	25



5502B A1 A2



ES Papelera metálica para reciclaje pintada en color grafito texturado. Tapa superior abatible y 2 depósitos en el interior.

EN Recycling bin painted in textured graphite color. Lid swing top and 2 deposits inside.



FR Corbeille à papier de recyclage métallique peint en graphite texture. Couvercle à charnière et 2 dépôts à l'intérieur.







DE Recyclingpapierkorb in texturierte Graphit. Deckel Swing top und 2 Einlagen auf der Innenseite.



*optional
optional
optionnel
wahlweise



	Ref. 5502B_	A 71 cm	B 61 cm	C 31 cm	35 L + 35 L
	A1		A2		A3
	A4		A5		A6

	Ref. 5502P_	A 71 cm	B 61 cm	C 31 cm	35 L + 35 L
	A1		A2		A3
	A4		A5		A6



2902B A1 A2 A3

ES Papelera metálica para reciclaje pintada en color grafito texturado. Tapa superior abatible y 3 depósitos en el interior.

EN Recycling bin painted in textured graphite color. Lid swing top and 3 deposits inside.

FR Corbeille à papier de recyclage métallique peint en graphite texture. Couverture à charnière et 3 dépôts à l'intérieur.

DE Recyclingpapierkorb in texturierte Graphit. Deckel Swing top und 3 Einlagen auf der Innenseite.



		Ref. 2902B_	A 71 cm	B 73,5 cm	C 25,5 cm	26 L + 26 L + 26 L
						
		Ref. 2902P_	A 71 cm	B 73,5 cm	C 25,5 cm	26 L + 26 L + 26 L
						



460038



460041

460042

460038



ES Papelera con pedal de acero inoxidable, depósito interior de plástico con asa, reborde de plástico en la base anticorrosión, disponible en 5, 12, 20 y 30 Litros.

EN Bin with pedal made of stainless steel, interior deposit made of plastic with a handle, ledge of plastic with an anti-rust base, available in 5, 12, 20 and 30 litres.

FR Poubelle à pédale en acier inoxydable, récipient intérieur en plastique avec poignée, cercle protecteur en plastique anticorrosion, disponible en 5, 12, 20 et 30 litres.

DE Rostfreier Stahlabfalleimer mit Pedal, Kunststoffbehälter mit Griff, Kunststofffassung mit rostresistenter Grundfläche, lieferbar in 5, 12, 20 und 30 Liter.

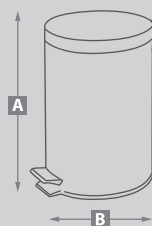

	A	B	
Ref. 460038	26,5 cm	19,5 cm	5L
Ref. 460040	38 cm	24,5 cm	12L
Ref. 460041	44,5 cm	29,2 cm	20L
Ref. 460042	64 cm	29,2 cm	30L



430035



430034



430036

ES Papeleras metálicas fabricadas en acero inoxidable o acero pintado epoxy negro.

EN Metal wastepaper baskets manufactured in stainless steel or black epoxy painted steel.

FR Corbeilles à papier métalliques fabriquées en acier inoxydable ou en acier peint epoxy noir.

DE Metallpapierkörbe in Edelstahl oder schwarz lackiertem Stahl.

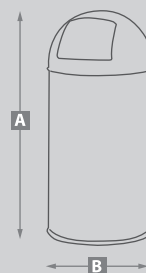

	A	B	
Ref. 430034	74 cm	35 cm	40 L
Ref. 430035	74 cm	35 cm	40 L
Ref. 430036	74 cm	38 cm	40 L

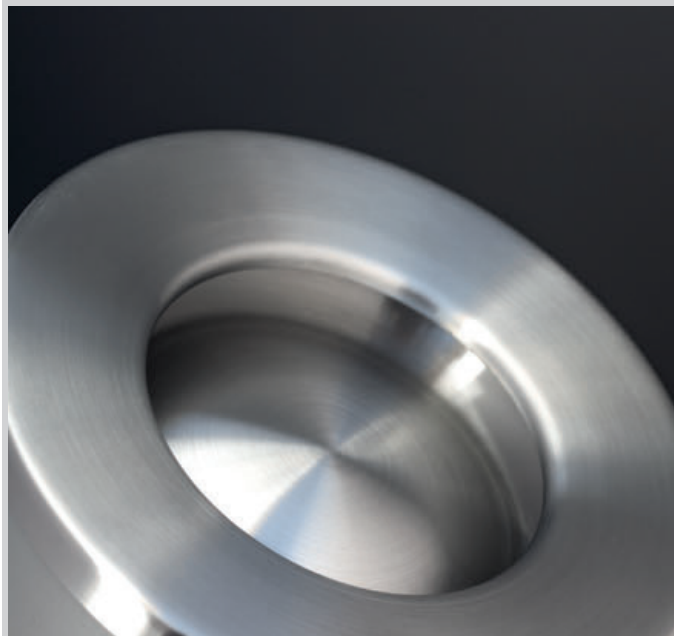

ES Papelera-cenicero metálico. Tapa / recoge colillas: Aluminio.

EN Metal wastepaper basket-ashtray. Lid / Ashtray base: Aluminium.

FR Corbeille à papier-cendrier métallique. Le couvercle / collecteur de mégots: Aluminium.

DE Standschenbecher mit integriertem Abfalleimer aus Metall. Deckel / Sammelbehälter für Zigarettenkippen: Aluminium

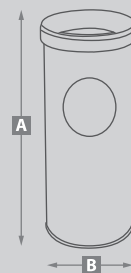

	A	B	
Ref. 5797_	62,5 cm	21,5 cm	24 L

Ref. 5799_	62,5 cm	21,5 cm	24 L
------------	---------	---------	------

01	02
----	----



5894 01



5895 02



5896 02

ES Cenicero metálico. Tapa de aluminio.
No incluye tierra.

EN Metal ashtrays. Aluminium lid.
Grit not included.

FR Cendriers métalliques. Couvercle en aluminium.
Terre non incluse.

DE Aschenbecher aus Metall. Aluminium-Deckel.
Sand nicht enthalten.

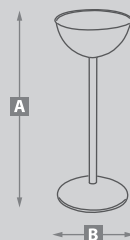

	A	B
Ref. 5894_	74,5 cm	29 cm
Ref. 5895_	78 cm	26 cm
Ref. 5896_	69,5 cm	25 cm
01	02	

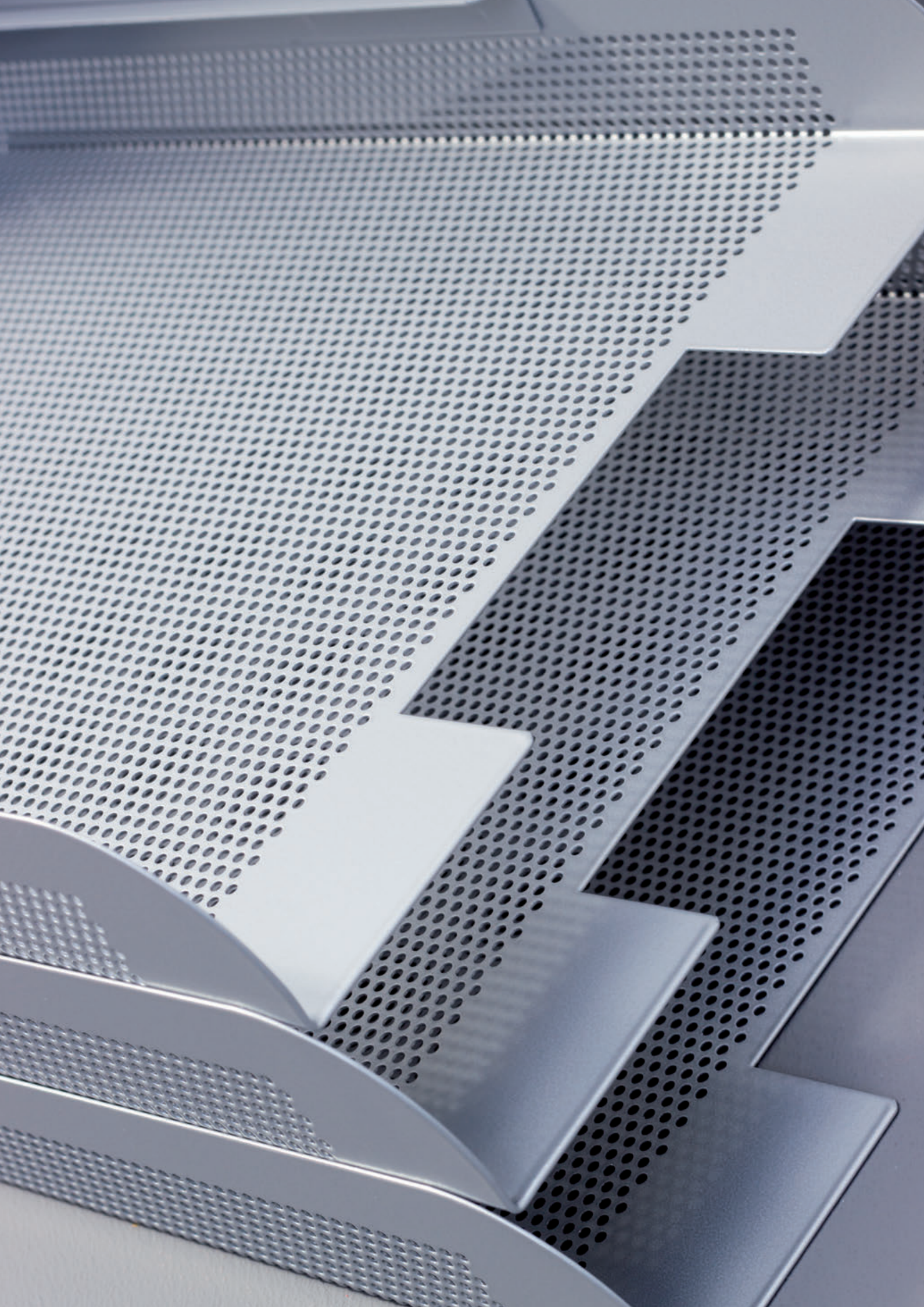

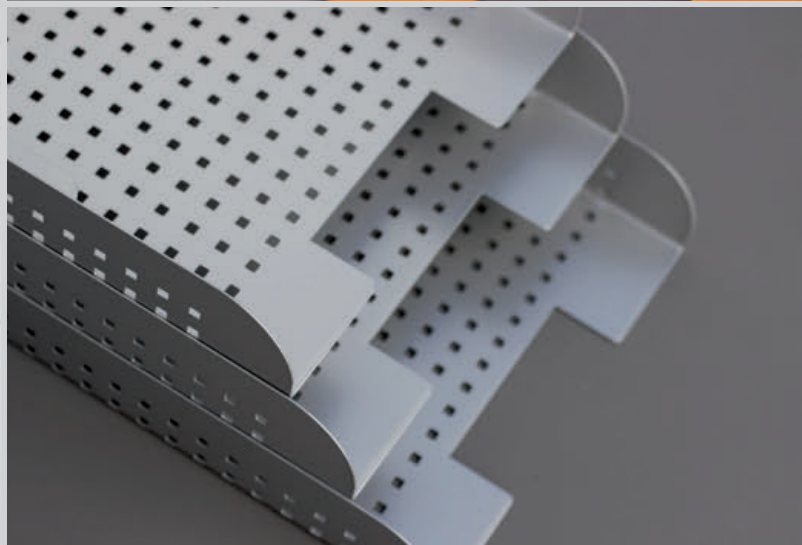
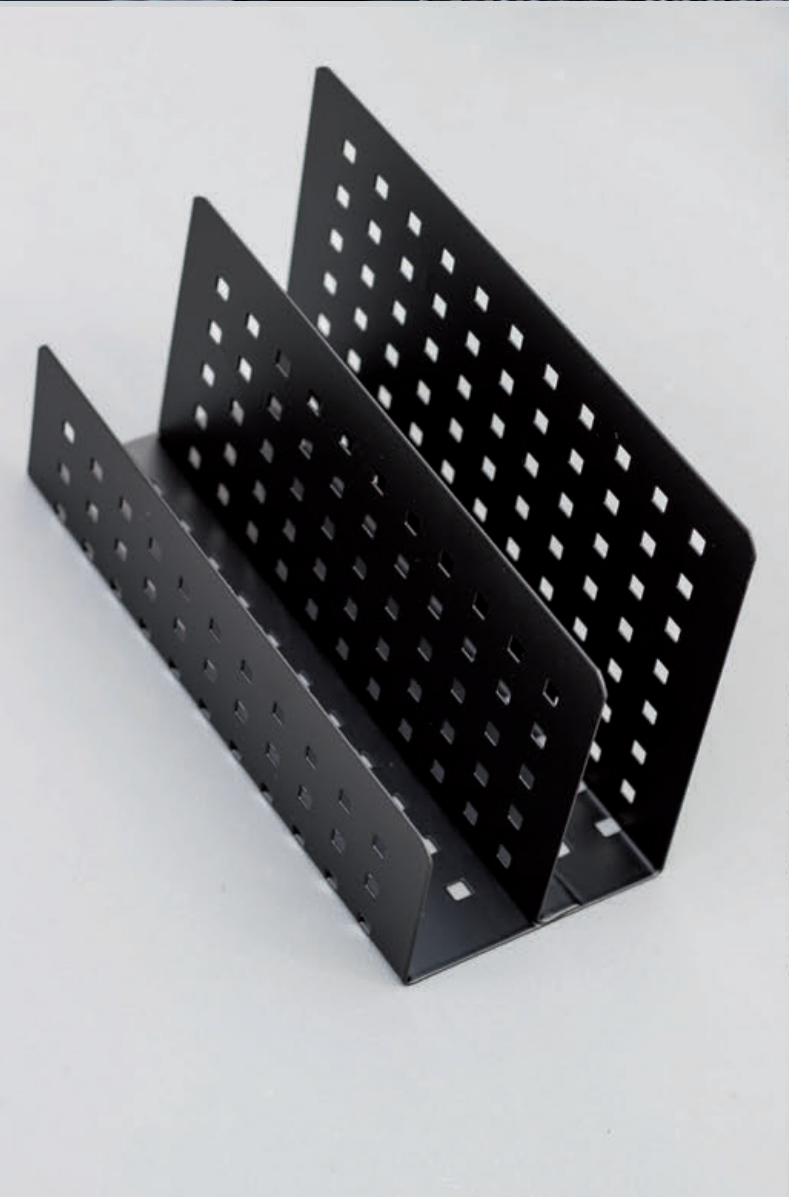

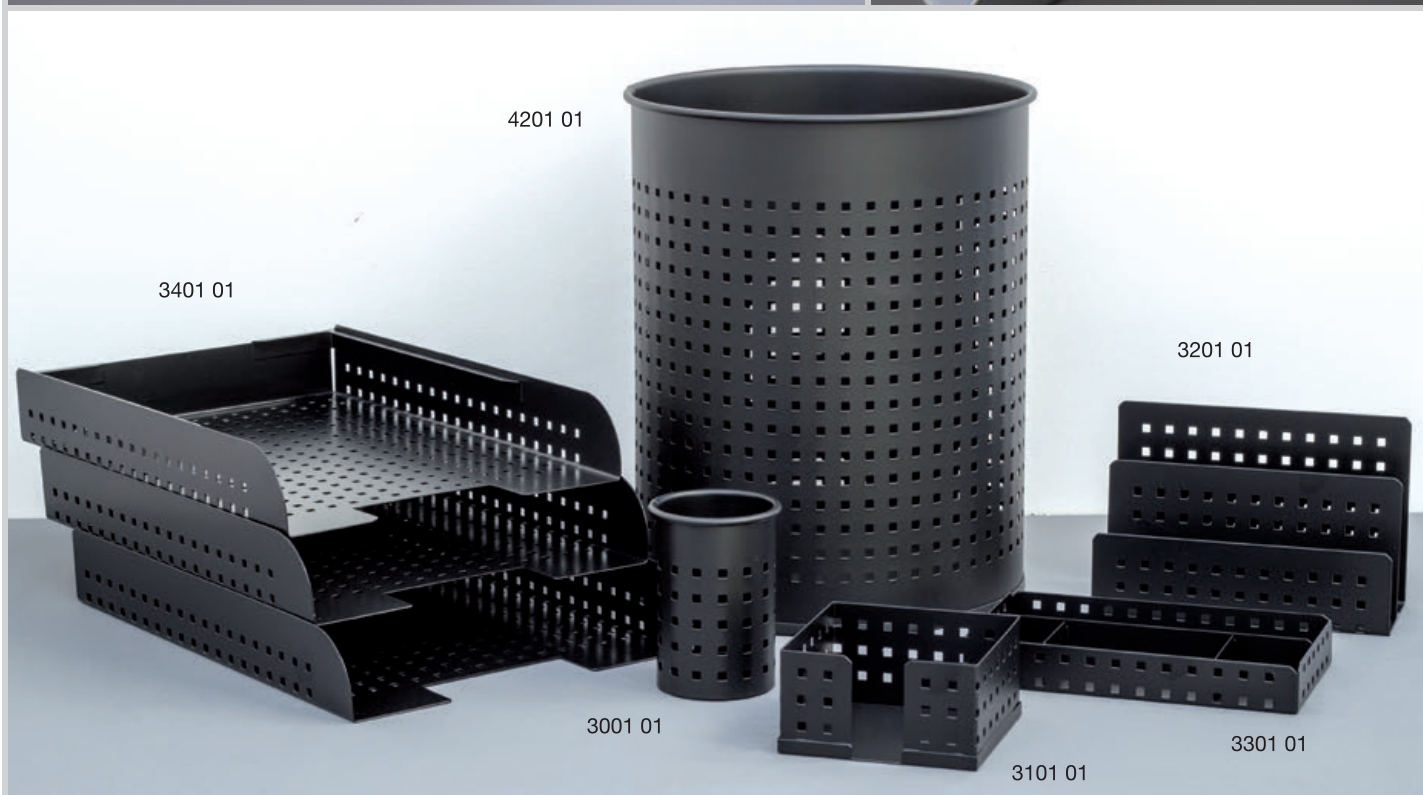
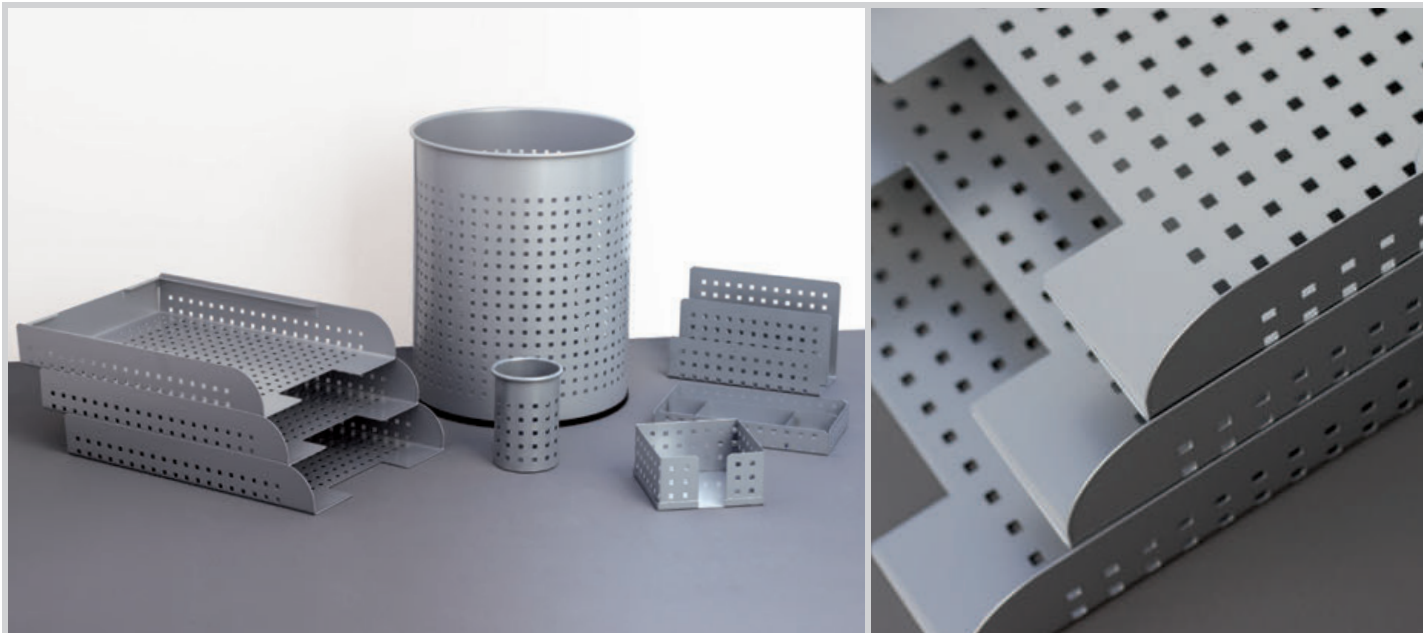

ES Complementos de alta calidad, resistentes y elegantes, fabricados en metal con perforación cuadrada de 5 mm.

EN Complements of high quality, resistant and elegant, fabricated in metal with square perforation of 5 mm.

FR Compléments de haute qualité, résistants et élégants, fabriqués en métal avec perforation carrée de 5 mm.

DE Ergänzungen der Qualität, beständig und elegant, gebildet im Metall mit quadratischer Perforierung von 5 mm.

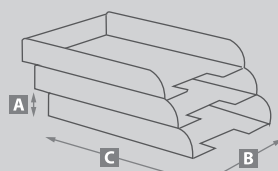

Ref. **4201_** **A** 31 cm **B** 26 cm **C** 26 cm



Ref. **3001_** 11 cm 7,5 cm 7,5 cm



Ref. **3401_** 5 cm 33 cm 24 cm



Ref. **3301_** 3 cm 20 cm 11,5 cm



Ref. **3101_** 6 cm 11 cm 11 cm



Ref. **3201_** 12 cm 18,5 cm 8 cm

01 **02**



ES Complementos de alta calidad, resistentes y elegantes, fabricados en metal con perforación redonda de 2,5 mm.

EN Complements of high quality, resistant and elegant, fabricated in metal with round perforation of 2,5 mm.





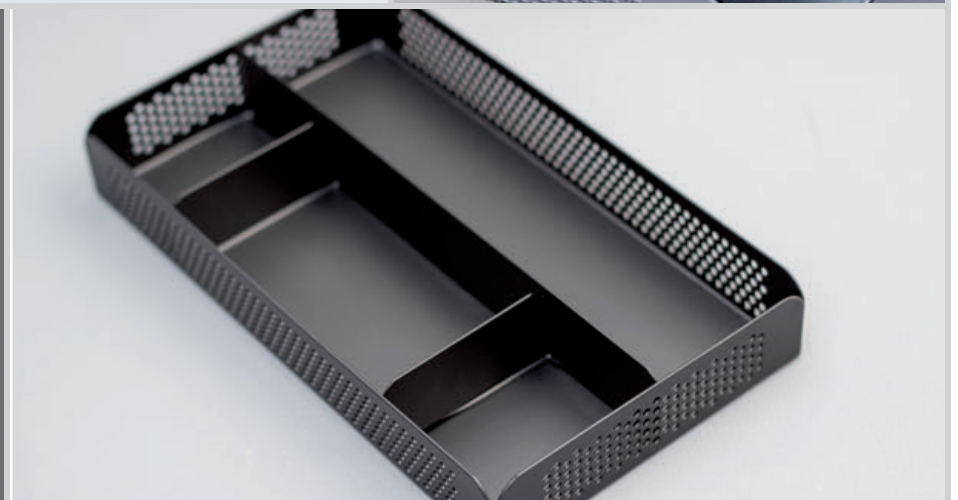

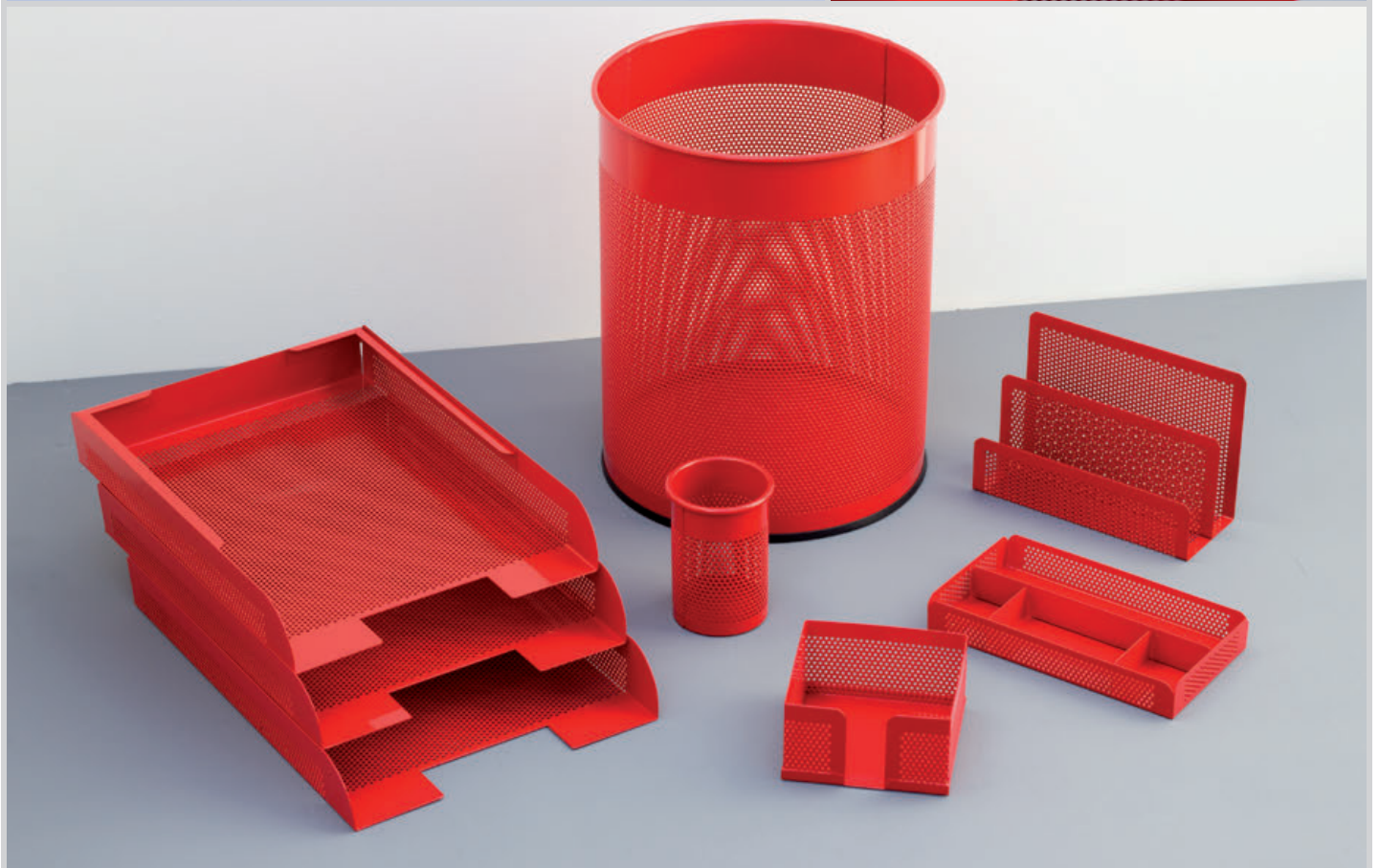
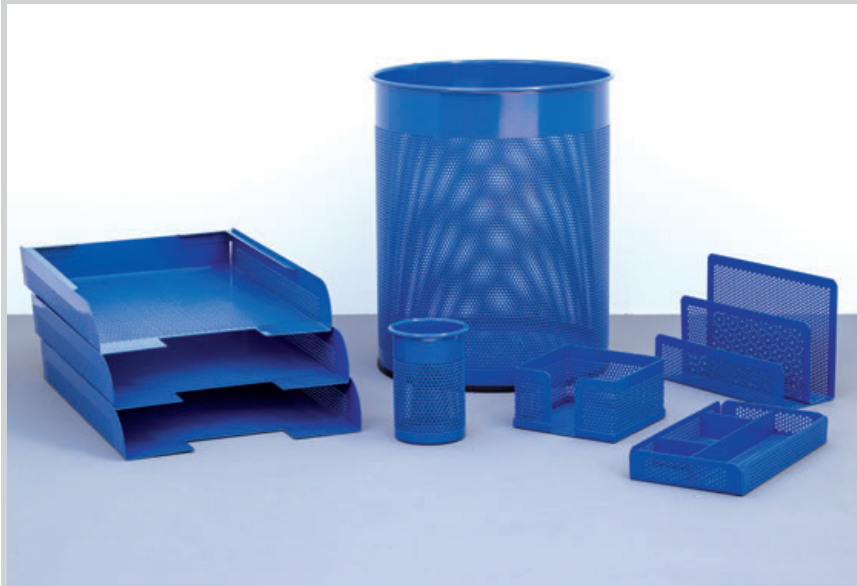
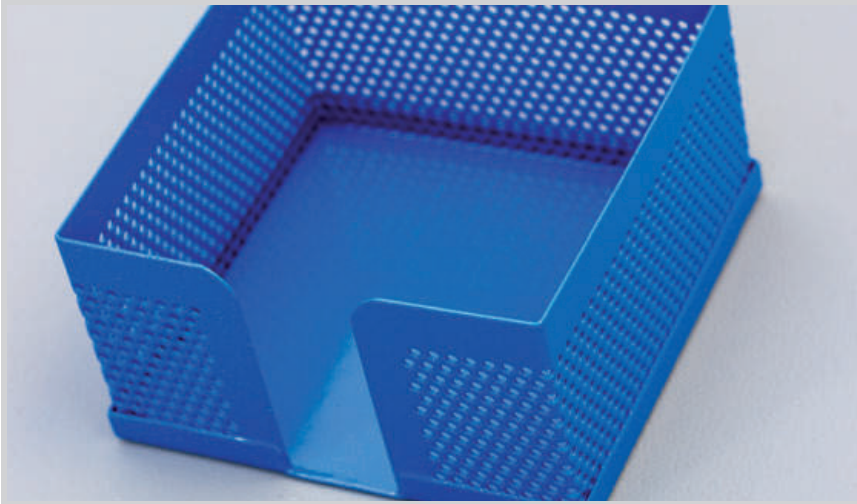
FR Compléments de haute qualité, résistants et élégants, fabriqués en métal avec perforation ronde de 2,5 mm.

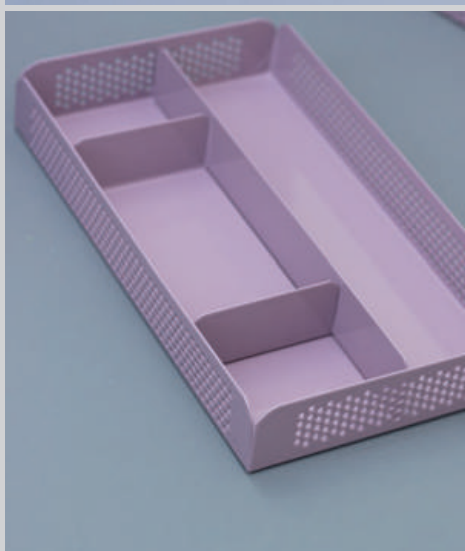
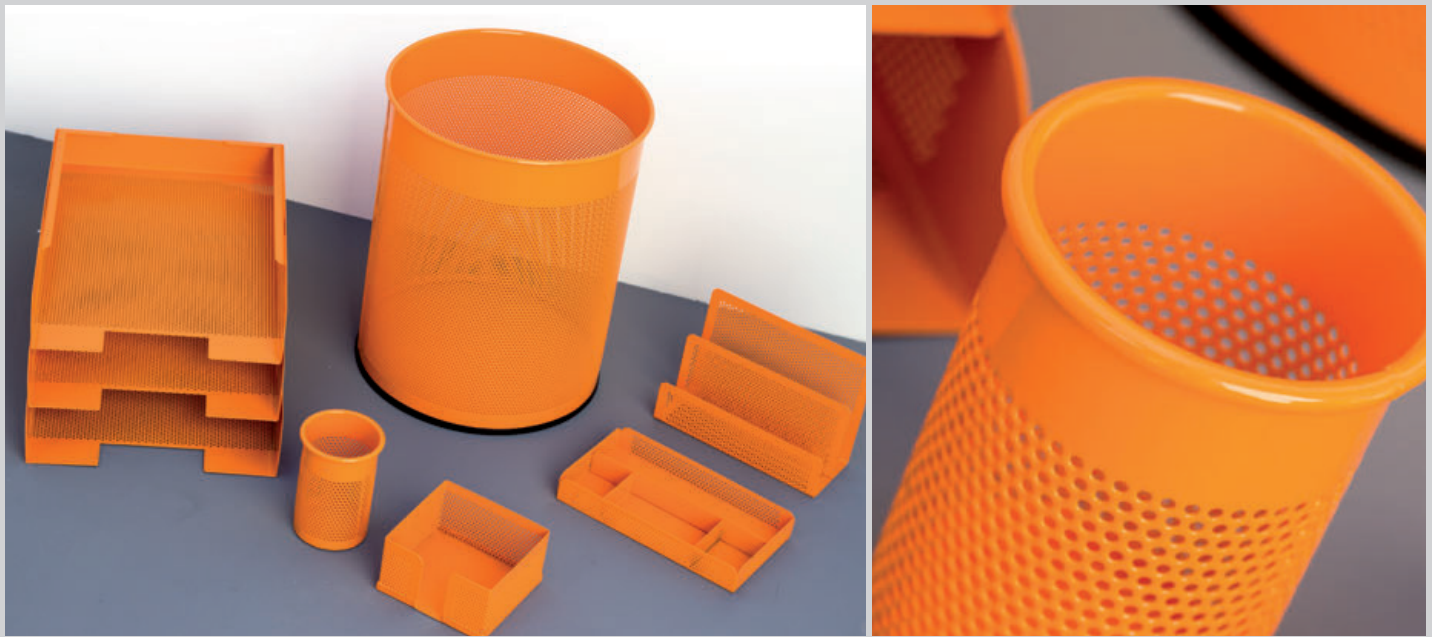
DE Ergänzungen der Qualitäts, beständig und elegant, gebildet im Metall mit runder Perforierung von 2,5 Milimeter.







		A	B	C
	Ref. 4203_	31 cm	26 cm	26 cm
	Ref. 3003_	11 cm	7,5 cm	7,5 cm
	Ref. 3403_	5 cm	33 cm	24 cm
	Ref. 3303_	3 cm	20 cm	11,5 cm
	Ref. 3103_	6 cm	11 cm	11 cm
	Ref. 3203_	12 cm	18,5 cm	8 cm

01	02	03	04	07	08	27
----	----	----	----	----	----	----

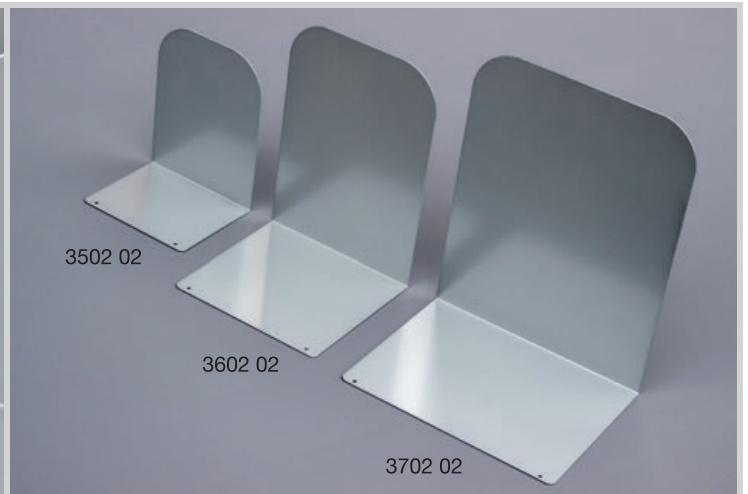

- ES** Soportalibros metálico.
- EN** Metal book stand.
- FR** Serre-livres métalliques.
- DE** Buchstützen aus Metall.

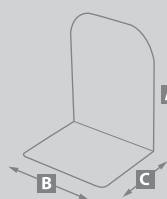

	A	B	C
Ref. 3502_	15 cm	12 cm	9,5 cm
Ref. 3602_	21 cm	15 cm	13,5 cm
Ref. 3702_	25 cm	20 cm	15 cm

01 **02**



3690 02

3590 02

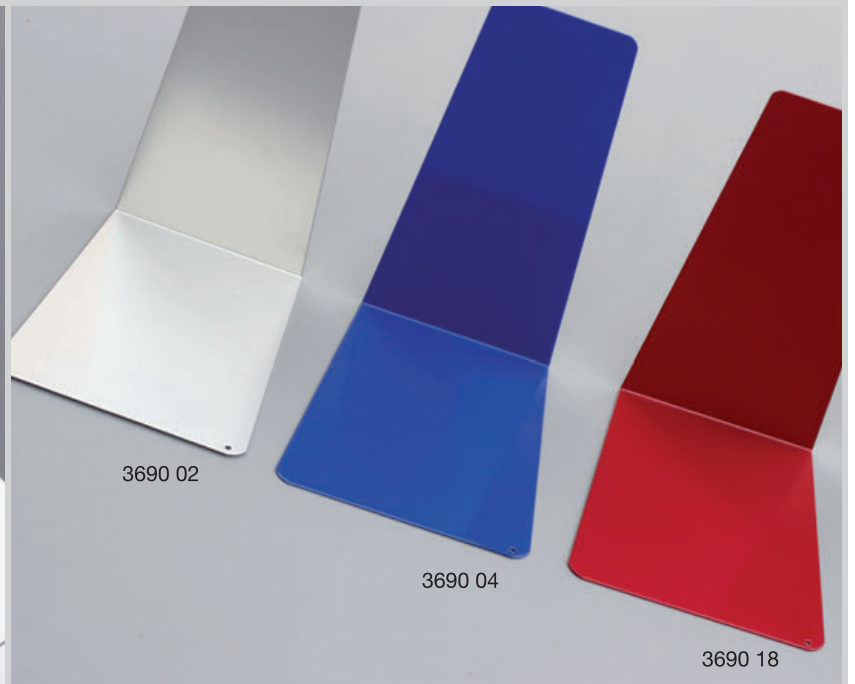

3690 02

3690 04

3690 18

- ES** Soportalibros metálico.
- EN** Metal book stand.
- FR** Serre-livres métalliques.
- DE** Buchstützen aus Metall.

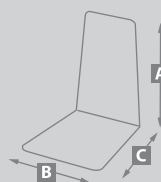

	A	B	C
Ref. 3590_	15 cm	11,5 cm	13,5 cm
Ref. 3690_	22 cm	14,5 cm	18 cm

01 02 04 18

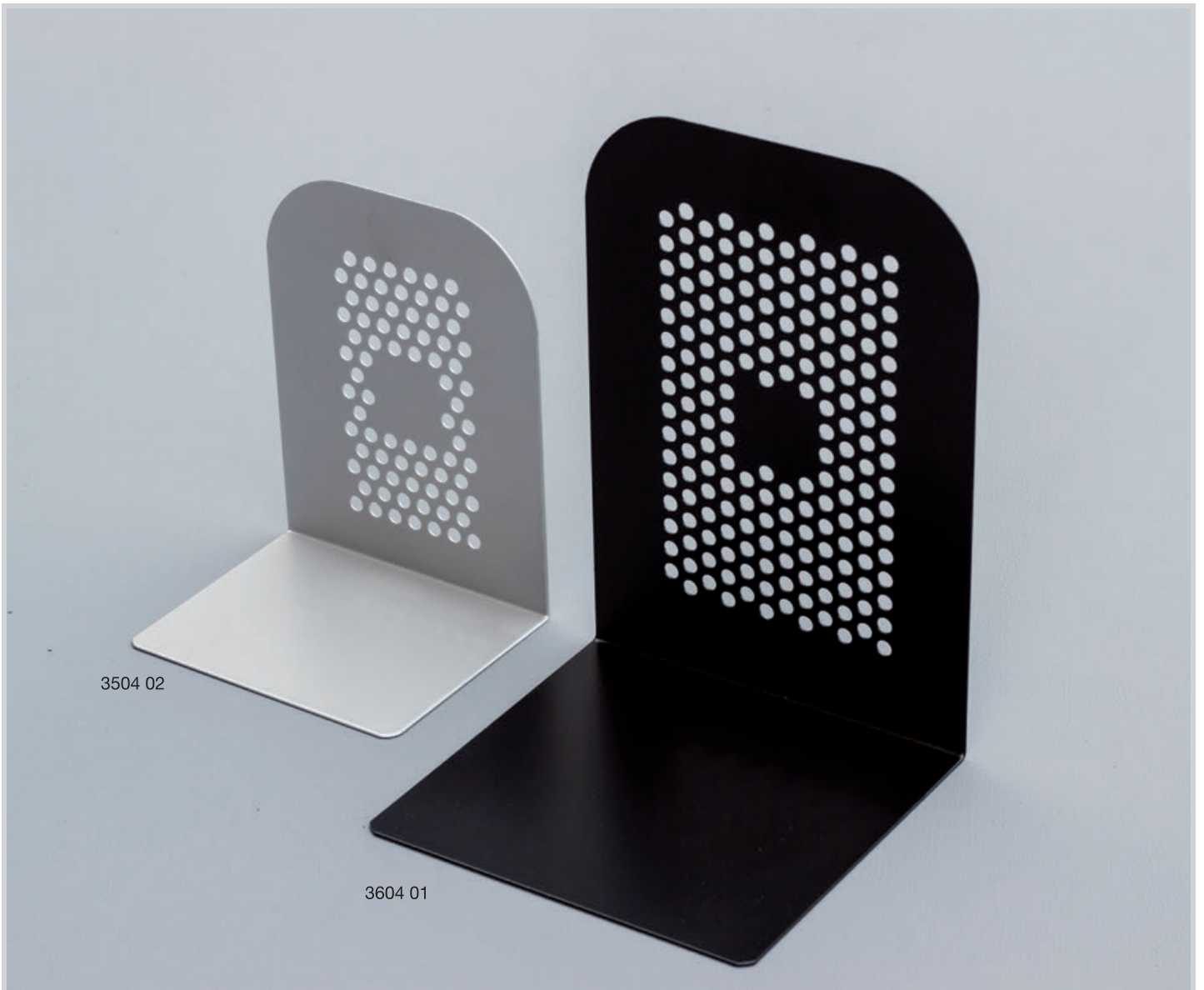

3504 02

3604 01



3504 01

3604 01

- ES** Soportalibros metálico.
- EN** Metal book stand.
- FR** Serre-livres métalliques.
- DE** Buchstützen aus Metall.

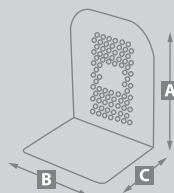

	A	B	C
Ref. 3504_	15 cm	12 cm	9,5 cm
Ref. 3604_	21 cm	15 cm	13,5 cm

01 02

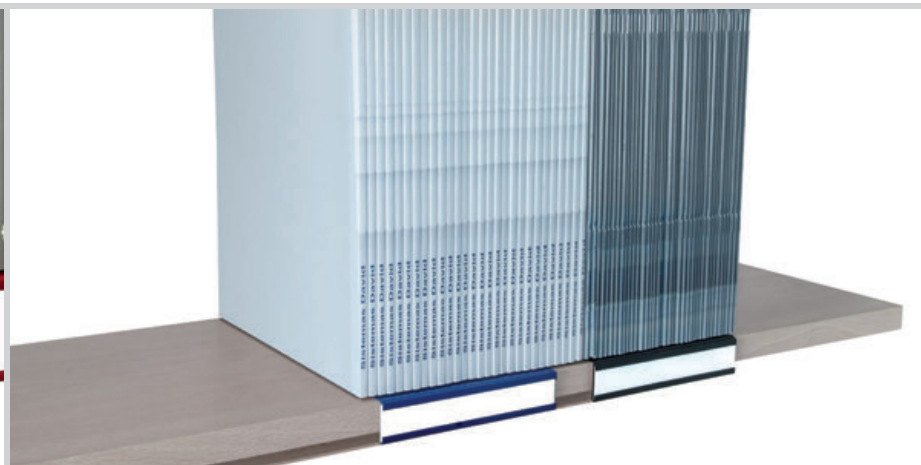
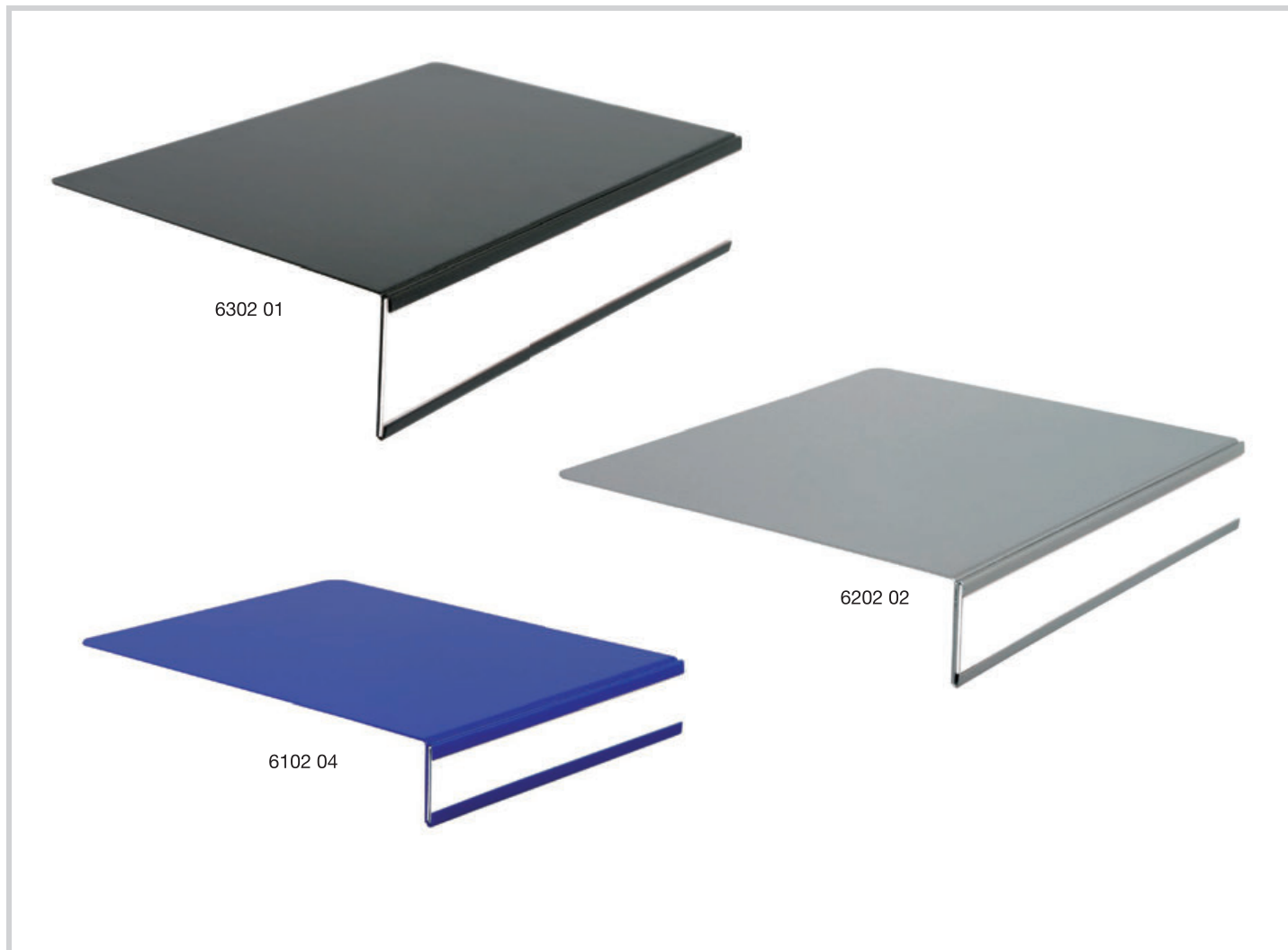

ES Etiquetero metálico, pintado en negro, plata, azul y granate. Útil para la señalización y orientación de estanterías.

EN Metal label holder, painted in black, silver, blue and maroon. Useful for labelling and organising shelves.

FR Porte-étiquette métallique, peint en noir, argent, bleu et grenat. Utile pour la signalisation et l'orientation des étagères.

DE Etikettenhalter aus Metall, in schwarz, silber, blau und granatro. Nützlich um Regale zu beschriften und zu ordnen.

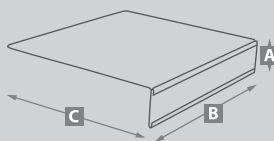

	A	B	C
Ref. 6102_	2,5 cm	13 cm	15,5 cm
Ref. 6202_	3,5 cm	20 cm	16,5 cm
Ref. 6302_	5 cm	25 cm	15,5 cm

01 02 04 18







ECO-LINE



ES Artículo metálico de gran utilidad para la delimitación y guiado de espacios.
Poste extensible con cinta de 2 m. / 3 m.
Cabezal con tres vías de enganche.

EN This metal item is extremely useful for dividing up and limiting access to areas.
Extendable post with of 2 and 3 metre belt.
Headpiece with three tracks for hooking up.

FR Article métallique de grande utilité pour la délimitation et le guidage d'espaces.
Poteau extensible avec sangle de 2 m. / 3 m.
Tête d'attelage à trois voies d'accrochage.

DE Nützlicher Artikel aus Metall um Bereiche einzugrenzen oder zur Wegmarkierung.
Absperrständer mit zwei und drei Meter langem Band.
Wandhalter mit Dreipunktaufhängung.

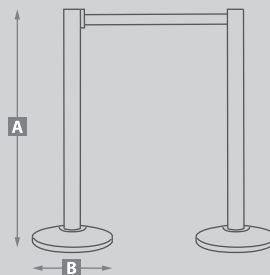

Ref. 7510301

01

A	B	
104 cm	36 cm	2 m
Cinta / Ribbons/ Rubans / Bänder:		C7

Ref. 7510312

12

A	B	
104 cm	36 cm	2 m
Cinta / Ribbons/ Rubans / Bänder:		C1



QUALITY

	A	B	
Ref. 72103_ _	95 cm	30 cm	2 m
Ref. 72104_ _	95 cm	30 cm	3 m

Colores / Colours / Couleurs / Farben:

01



Cinta / Ribbons / Rubans / Bänder:

C1 C4 C7

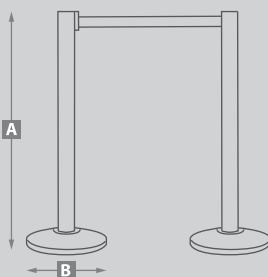

	A	B	
Ref. 73105_ _	95 cm	35 cm	3,2 m

Colores / Colours / Couleurs / Farben:

01 02 04 07 15 20 P



10 Cromado / Frame / Chrome / Chrom

11 Dorado / Golden / Or / Golden

12 Inox / Stainless / Inoxydable / Edelstahl



Cinta / Ribbons / Rubans / Bänder:

C1 C3 C4 C7 C9 C4 C15

C16 C17 C20

QUALITY

COMPLEMENTOS / ACCESSORIES / COMPLÉMENTS / ZUBEHÖR

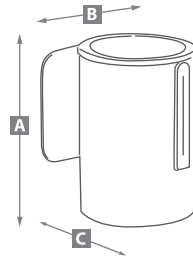





Ref.	A	B	C	
74106_	12 cm	9 cm	7,5 cm	2,5 m
74107_	12 cm	9 cm	7,5 cm	3,7 m

Ref.	A	B
73109	9 cm	7 cm





Cinta / Ribbons / Rubans / Bänder:



-  Soporte mural con cinta extensible retráctil. Artículo ideal para el cierre de pasillos, zonas de paso etc. Fabricado con materiales muy resistentes, permitiendo ser utilizado a diario en multitud de ocasiones.
-  Wall mounted retractable belt barrier. The perfect item for closing corridors, passageways etc. Made of highly resistant materials, allowing it to be used on a daily basis and on multiple occasions.
-  Support mural avec du ruban extensible rétractable: Produit idéal pour fermer des couloirs, des zones de passage, etc. Fabriqué en matériel très résistant, lui permettant d'être utilisé quotidiennement à de nombreuses reprises.
-  Wandbefestigung für Zugband. Geeignet für Korridore oder um Fußgängerüberwege zu sperren. Aus widerstandsfähigen Materialien hergestellt, sehr nützlicher Artikel geeignet für den Alltag.







Ref. 73110

-  Cierre con bloqueo de seguridad y botón de desbloqueo.
-  Lock with security block and unlock button.
-  Fermeture avec serrure de sécurité et bouton de déverrouillage.
-  Sperren und Entsperren Sicherheitsknopf.







Ref. 73108

-  Cintas personalizadas.
-  Personalized ribbons.
-  Rubans personnalisés.
-  Personalisierte Bänder.



Ref.	A	B	
73111/A4V	22 cm	30 cm	A4V
73112/A4H	45 cm	42 cm	A4H

-  Soporte porta carteles, fabricado en metal.
-  Support for poster holder made of metal.
-  Support porte affiches, en métal.
-  Info-Tafel, hoch aus Metall hergestellt.

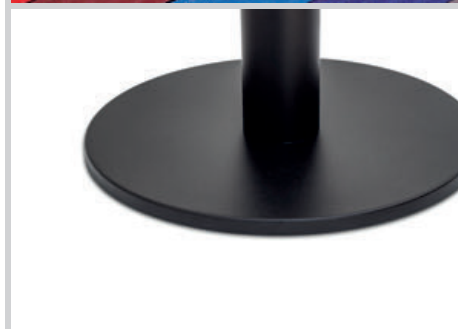



7002 01



7002 10



7002 11

ES Artículo metálico de gran utilidad para la delimitación y guiado de espacios .
Fabricado en varios acabados : negro , plata , cromado y dorado.
Cuerdas . Longitud: 1 mt. / 1,5 mt. Colores: negro, azul, burdeos y beige.

EN This metal item is extremely useful for dividing up and limiting access to areas.
Made in a variety of finishes: black, silver, chrome and gold.
Ropes. Length: 1 m / 1.5 m. Colours: black, blue, burgundy and beige.

FR Article métallique de grande utilité pour la délimitation et le guidage d'espaces.
Fabriqué en plusieurs finitions : noir, argent, chromé et doré.
Cordes. Longueur : 1 m./1,5 m. Couleurs : noir, bleu, bordeaux et beige.

DE Nützlicher Artikel aus Metall um Bereiche einzugrenzen oder zur Wegmarkierung.
Hergestellt in verschiedenen Farben: Schwarz, Silber, Chromfarben und Gold.
Länge Kordeln: 1 m / 1,5 m. Farben: Schwarz, Blau, Bordeaux und Beige.

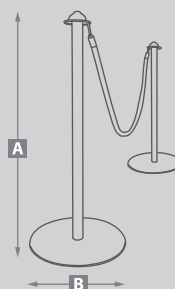

Ref. 7002_ ^A 96 cm ^B 33 cm
01 02 10 11



Ref. 70CP_ 1 m
Ref. 71CP_ 1,5 m
01 04 18 32



7102 11



7102 02



7102 10

ES Artículo metálico de gran utilidad para la delimitación y guiado de espacios.
Fabricado en varios acabados : negro , plata , cromado y dorado.
Cuerdas . Longitud: 1 mt. / 1,5 mt. Colores: negro, azul, burdeos y beige.

EN This metal item is extremely useful for dividing up and limiting access to areas.
Made in a variety of finishes: black, silver, chrome and gold.
Ropes. Length: 1 m / 1.5 m. Colours: black, blue, burgundy and beige.

FR Article métallique de grande utilité pour la délimitation et le guidage d'espaces.
Fabriqué en plusieurs finitions : noir, argent, chromé et doré.
Cordes. Longueur : 1 m./1,5 m. Couleurs : noir, bleu, bordeaux et beige.

DE Nützlicher Artikel aus Metall um Bereiche einzugrenzen oder zur Wegmarkierung.
Hergestellt in verschiedenen Farben: Schwarz, Silber, Chromfarben und Gold.
Länge Kordeln: 1 m / 1,5 m. Farben: Schwarz, Blau, Bordeaux und Beige.

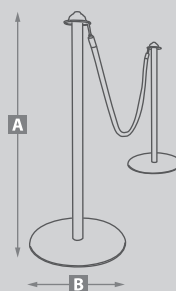

Ref.	7102_	A	B
		96 cm	38 cm
	01 02 10 11		



Ref.	70CP_	1 m
Ref.	71CP_	1,5 m
	01 04 18 32	





602902 (P)



602502 (P)



603102 S31



602902_



602302_

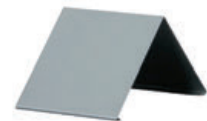

603102_



603002_



602402_



602502_

ES Señalización para sobremesa de doble cara, Artículo metálico de gran utilidad para cambios frecuentes de rótulos.

EN Signaling double-sided desktop, metal article of great use to frequent changes of signs.

FR Signalisation bureau double face, objet métallique d'une grande utilité à de fréquents changements de signes.

DE Signalisierung doppel-seitige Desktop, Metall Artikel von großem Nutzen für häufige Änderungen der Zeichen.



Ref.	A	B	C	D	Ref.	A	B	C	D
602902_	6,5 cm	30,5 cm	13 cm	9 cm	602302_	3,5 cm	30,5 cm	6 cm	4 cm
603002_	6,5 cm	25 cm	13 cm	9 cm	602402_	3,5 cm	25 cm	6 cm	4 cm
603102_	6,5 cm	8,5 cm	13 cm	9 cm	602502_	3,5 cm	8,5 cm	6 cm	4 cm

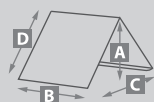

ES Si desea textos y pictogramas personalizados, solicite presupuesto.
EN Please ask for a quote if you wish to Texts and custom pictograms.
FR Si vous souhaitez textes et pictogrammes personnalisés, demandez un devis.
DE Wenn Sie Text und benutzerdefinierte Piktogramme möchten, beantragen Sie bitte einen Kostenvorschlag.



603302



603402



602702



603202



602602



603402



603302



602702



602802

ES Señalización para sobremesa de doble cara, Artículo metálico de gran utilidad para cambios frecuentes de rótulos.

EN Signaling double-sided desktop, metal article of great use to frequent changes of signs.

FR Signalisation bureau double face, objet métallique d'une grande utilité à de fréquents changements de signes.

DE Signalisierung doppelseitige Desktop, Metall Artikel von großem Nutzen für häufige Änderungen der Zeichen.

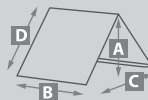

Ref.	A	B	C	D
603202	6,5 cm	30,5 cm	13 cm	9 cm
603302	6,5 cm	25 cm	13 cm	9 cm
603402	6,5 cm	8,5 cm	13 cm	9 cm
602602	3,5 cm	30,5 cm	6 cm	4 cm
602702	3,5 cm	25 cm	6 cm	4 cm
602802	3,5 cm	8,5 cm	6 cm	4 cm



603502



603602

ES Rótulo metálico mural, para cambios frecuentes de señalización. Artículo para ser fijado con tornillos, si se desea fijación adhesiva especificar en el pedido. Incluye plástico protector.

EN Wall metal label, signaling frequent changes. Article to be secured with screws if desired adhesive bonding specify when ordering. Includes protective plastic.

FR Signe de la paroi métallique, signalisation à de fréquents changements. Article d'être fixé avec des vis, si adhésif souhaité bonding préciser lors de la commande. Comprend plastique de protection.

DE Wand Metall Label, häufige Änderungen signalisiert. Artikel mit Schrauben, festgesetzt werden, wenn gewünschte Klebstoff zementieren bitte in der Reihenfolge angeben. Enthält schützende Kunststoff.

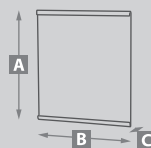

	A	B	C
Ref. 603502	17,5 cm	30,5 cm	0,5 cm
Ref. 603602	17,5 cm	18 cm	0,5 cm
Ref. 603702	14,5 cm	30,5 cm	0,5 cm
Ref. 603802	14,5 cm	14,5 cm	0,5 cm



6041 15 S14 S01



6040 19 S06

ES Rótulo metálico mural. Artículo para ser fijado con tornillos, si se desea fijación adhesiva especificar en el pedido. Color etiqueta vinilo : Blanco y negro.

EN Wall metal label. Article to be secured with screws if desired adhesive bonding specify when ordering. Colored vinyl label: White and black.

FR Signe de la paroi métallique. Article d'être fixé avec des vis, si adhésif souhaité bonding préciser lors de la commande. Étiquette de vinyle de couleur: Blanc et noir.

DE Wand Metall Label. Artikel mit Schrauben, festgesetzt werden, wenn gewünschte Klebstoff zementieren bitte in der Reihenfolge angeben. Coloured vinyl Label: Weiß und schwarz.



Ref.	A	B	C	Ref.	A	B	C
6039_ _	14,5 cm	14,5 cm	1,5 cm	6072_ _	14,5 cm	94 cm	1,5 cm
6040_ _	17,5 cm	17,5 cm	1,5 cm	6073_ _	17,5 cm	48 cm	1,5 cm
6041_ _	14,5 cm	23,5 cm	1,5 cm	6074_ _	17,5 cm	94 cm	1,5 cm
6042_ _	17,5 cm	31,5 cm	1,5 cm	6075_ _	48 cm	48 cm	1,5 cm
6071_ _	14,5 cm	48 cm	1,5 cm	6076_ _	48 cm	94 cm	1,5 cm

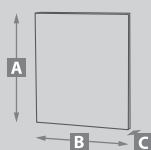

ES Si desea textos y pictogramas personalizados, solicite presupuesto.
EN Please ask for a quote if you wish to Texts and custom pictograms.
FR Si vous souhaitez textes et pictogrammes personnalisés, demandez un devis.
DE Wenn Sie Text und benutzerdefinierte Piktogramme möchten, beantragen Sie bitte einen Kostenvorschlag.



6046 15 S29 S28



6043 22 S15

ES Rótulo de doble cara. Artículo metálico de gran utilidad para la señalización y orientación de espacios. Color etiqueta vinilo : Blanco y negro.

EN Double-sided sign. This metal item is extremely useful for labelling and organising access to areas. Colored vinyl label: White and black.

FR Signe recto-verso. Article métallique de grande utilité pour la signalisation et l'orientation d'espaces. Étiquette de vinyle de couleur: Blanc et noir.

DE Double-sided Zeichen. Metall Artikel von großem Nutzen für die Beschilderung und Orientierung der Räume. Coloured vinyl Label: Weiß und schwarz.

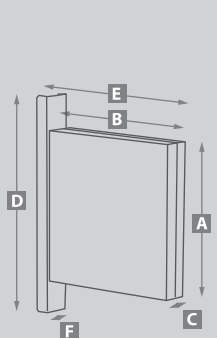

Ref.	A	B	C	D	E	F
6043_ _	14,5 cm	14,5 cm	3 cm	20,5 cm	16 cm	3 cm
6044_ _	17,5 cm	17,5 cm	3 cm	23,5 cm	19 cm	3 cm
6045_ _	14,5 cm	23 cm	3 cm	20,5 cm	24 cm	3 cm
6046_ _	17,5 cm	31 cm	3 cm	23,5 cm	33 cm	3 cm



ES Si desea textos y pictogramas personalizados, solicite presupuesto.
EN Please ask for a quote if you wish to Texts and custom pictograms.
FR Si vous souhaitez textes et pictogrammes personnalisés, demandez un devis.
DE Wenn Sie Text und benutzerdefinierte Piktogramme möchten, beantragen Sie bitte einen Kostenvoranschlag.



110025



110025B

- ES** Señalización plegable para poder transportar y guardar fácilmente, mensaje impreso en inglés y español, con posibilidad de ser impreso en otros idiomas bajo pedido y según cantidades.
- EN** Foldable sign, easy to move and store, with message printed in English and Spanish, with the possibility to print in other languages on request and according to quantities.
- FR** Balise de signalisation pliante, facile à transporter et stocker, imprimée en anglais et espagnol, possibilité d'être imprimée en autres langues sur demande et en fonction des quantités.
- DE** Beschilderung zusammenklappbar für ein leichtes Verstauen sowie Transport. Vordruckte Mitteilung auf Englisch und Spanisch, mit der Möglichkeit es auch in anderen Sprachen zu drucken, je nach Bestellmenge.



	A	B
Ref. 110025	57 cm	30 cm
Ref. 110025B	93,5 cm	30 cm









ES Perchero metálico con 7 colgadores. Base muy estable

EN Metal coat rack with 7 hooks. Very stable base.

FR Portemanteau métallique avec 7 patères. Base très estable.

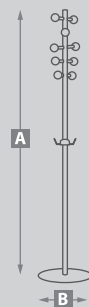
DE Garderobenständer Metall mit 7 Kleiderhaken. Sehr stabiler Fuß.



Ref. **9789C** **A** 175 cm **B** 38 cm  X 7

Ref. **978902** **A** 175 cm **B** 38 cm  X 7





ES Percheros metálicos pintados en color plata, blanco y rojo. Disponibles con colgadores en ABS negro.

EN Coat Racks painted in silver, white and red. Available with black ABS hooks.

FR Portemanteaux métallique peint en argent, blanc et rouge. Disponible avec patères en ABS noir.

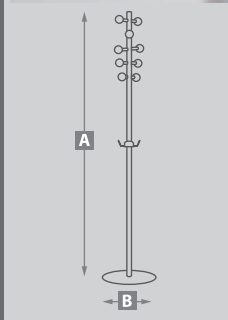
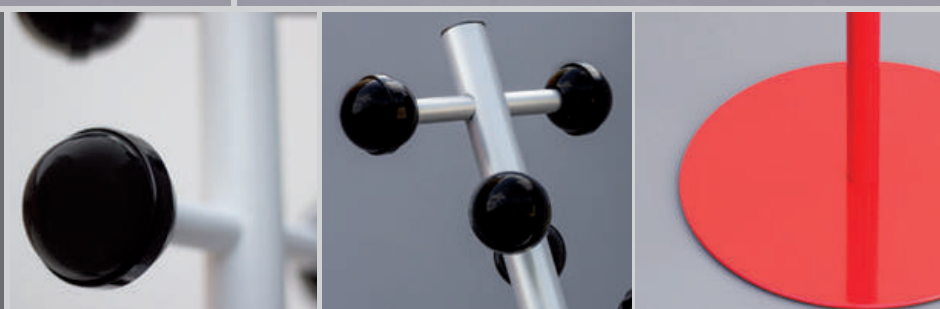
DE Kleiderständer in silber, weiß und rot lackiert. Erhältlich mit schwarzem Haltern.



	A	B	
Ref. 9267_	174 cm	35 cm	 X 8
Ref. 9268_	174 cm	35 cm	 X 10
	<input type="checkbox"/> 02	<input type="checkbox"/> 03	<input checked="" type="checkbox"/> 07





ES Percheros metálicos pintados en color plata y blanco. Disponibles con colgadores en forma de gancho.

EN Coat Racks painted in silver and white. Available with hook-shaped hangers.

FR Portemanteaux métallique peint en argent et blanc. Disponible avec des cintres en forme de crochet.

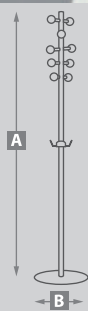
DE Kleiderständer in silber und weiß lackiert. Erhältlich mit hakenförmigen Kleiderbügel.



Ref. 9468_ **A** 174 cm **B** 35 cm  X 12

02 03





ES Percheros metálicos pintados en color plata, blanco y rojo. Disponibles con colgadores en ABS negro y perchas en forma de gancho.

EN Coat Racks painted in silver, white and red. Available with black ABS hooks and hook-shaped hangers.

FR Portamanteaux métallique peint en argent, blanc et rouge. Disponible avec patères en ABS noir et des cintres en forme de crochet.

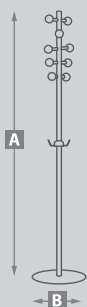
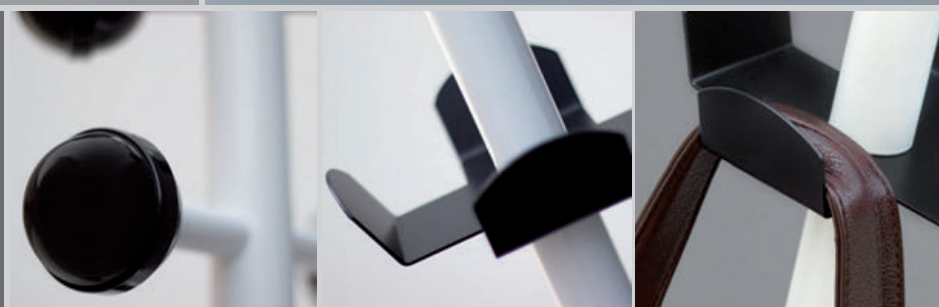
DE Kleiderständer in silber, weiß und rot lackiert. Erhältlich mit schwarzem Haltern und hakenförmigen Kleiderbügel.



Ref. 9868_ **A** 174 cm **B** 35 cm  X 10  X 4

02 03 07

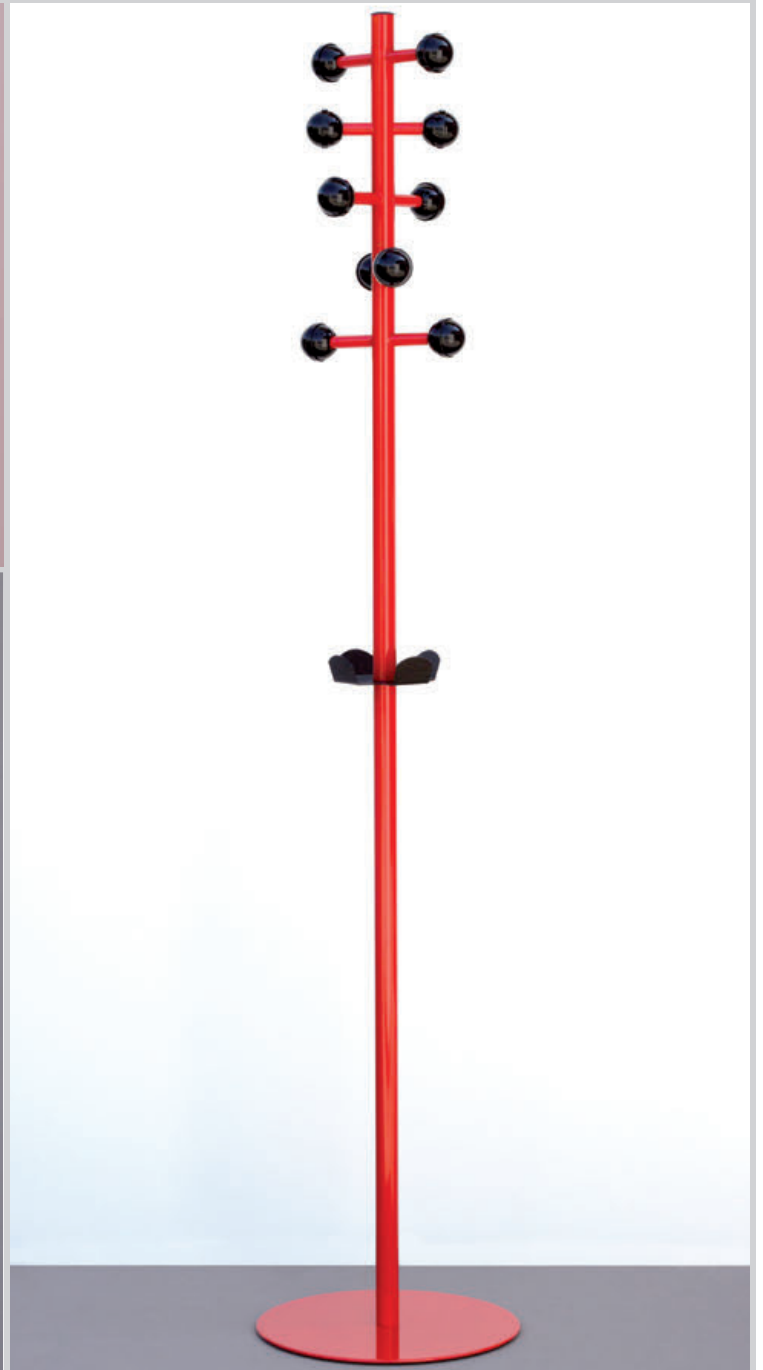
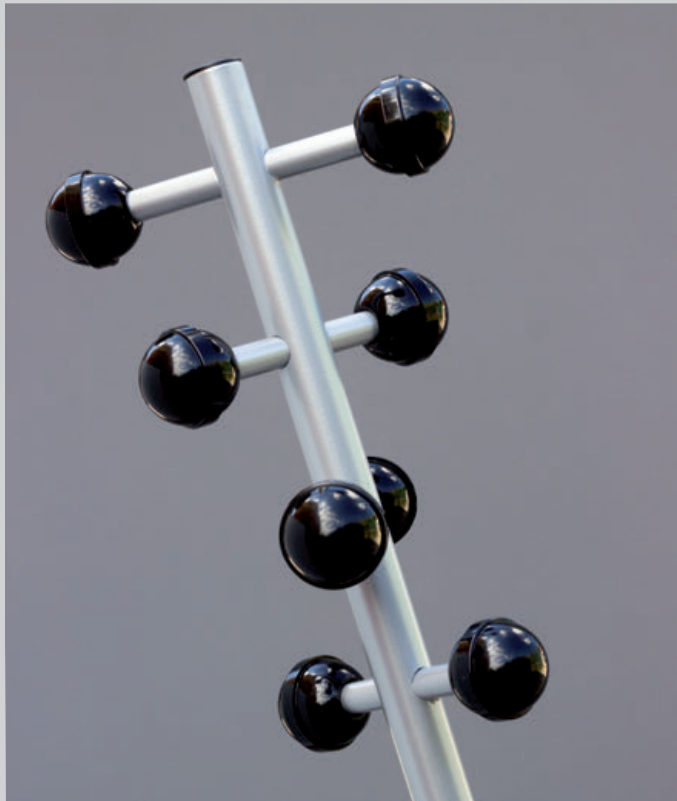

ES Percheros metálicos pintados en color plata, blanco y rojo. Disponibles con colgadores en ABS negro y perchas en forma de gancho.

EN Coat Racks painted in silver, white and red. Available with black ABS hooks and hook-shaped hangers.

FR Portamanteaux métallique peint en argent, blanc et rouge. Disponible avec patères en ABS noir et des cintres en forme de crochet.

DE Kleiderständer in silber, weiß und rot lackiert. Erhältlich mit schwarzem Haltern und hakenförmigen Kleiderbügel.

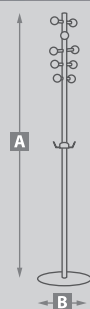
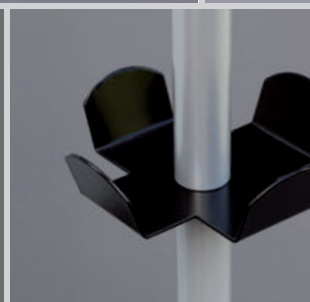

Ref. 9867_ **A** 174 cm **B** 35 cm  X 8 +  X 4

02 **03** **07**



916602



926702B



906602



ES Percheros metálicos pintados en color plata. Disponibles con colgadores en ABS negro.

EN Coat Racks painted in silver. Available with black ABS hooks.

FR Portemanteaux métallique peint en argent. Disponible avec patères en ABS noir.

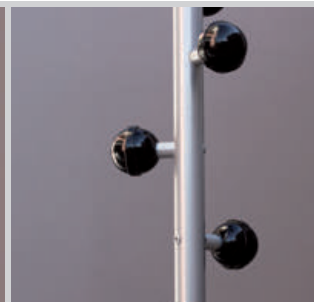
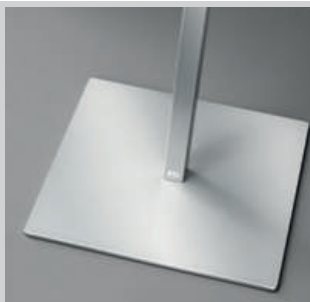
DE Kleiderständer in Silber. Erhältlich mit schwarzem Haltern.



	A	B	
Ref. 906602	173 cm	35 cm	 X 6
Ref. 906702	173 cm	35 cm	 X 8



	A	B	
Ref. 916602	173 cm	33 cm	 X 6
Ref. 926702B	173 cm	33 cm	 X 8



958302



956802

ES Percheros metálicos pintados en color plata. Disponibles con colgadores en ABS negro.

EN Coat Racks painted in silver. Available with black ABS hooks.

FR Portemanteaux métallique peint en argent. Disponible avec patères en ABS noir.

DE Kleiderständer in Silber. Erhältlich mit schwarzem Haltern.



956802S



958402

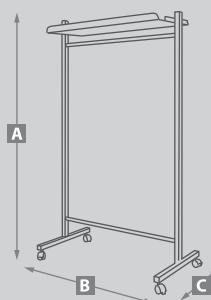

	A	B	C
Ref. 958302	175 cm	102 cm	56 cm
Ref. 958402	175 cm	102 cm	56 cm
Ref. 956802	175 cm	77,5 cm	56 cm
Ref. 956802S	175 cm	77,5 cm	56 cm

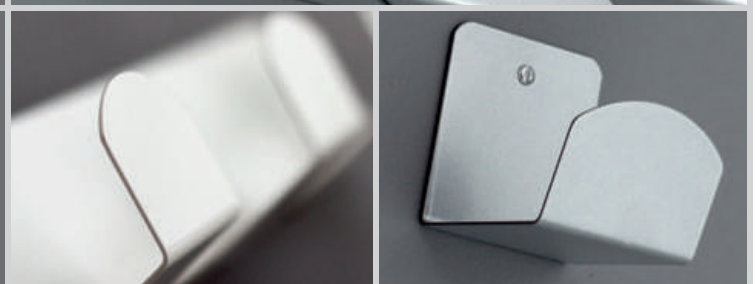
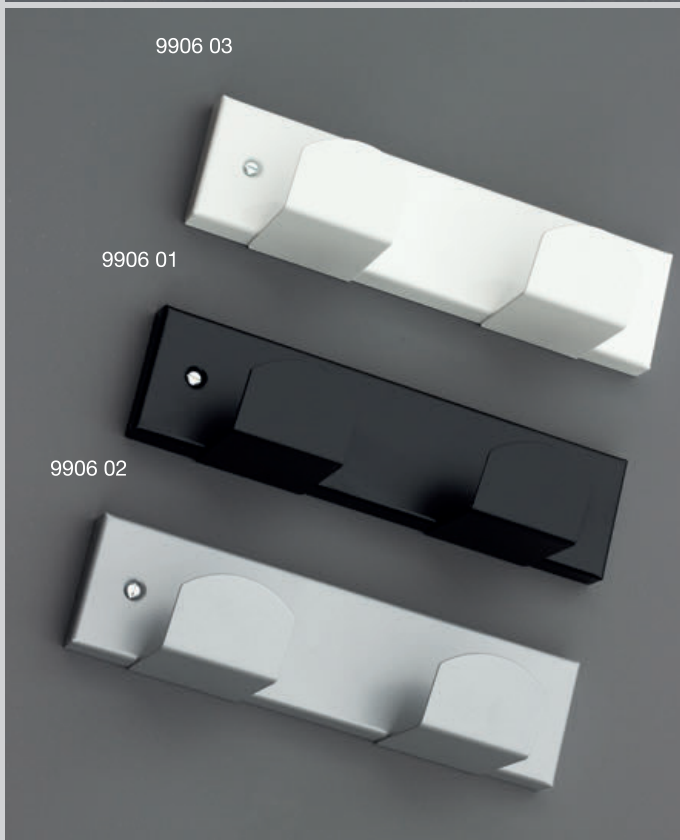



ES Percha de pared metálica, incluye accesorios para instalación.

EN Wall-mounted rack. Installation accessories included.

FR Portemanteau mural métallique. Les accessoires pour l'installation sont inclus.

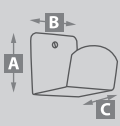
DE Wandhaken aus Metall. Enthält Zubehör zur Installation an Wänden.



	A	B	C	
Ref. 9905_	6 cm	5,5 cm	7 cm	1
Ref. 9906_	6,5 cm	24,5 cm	7 cm	2
Ref. 9907_	6,5 cm	37 cm	7 cm	3
Ref. 9908_	6,5 cm	49,5 cm	7 cm	4

01 02 03



9911302

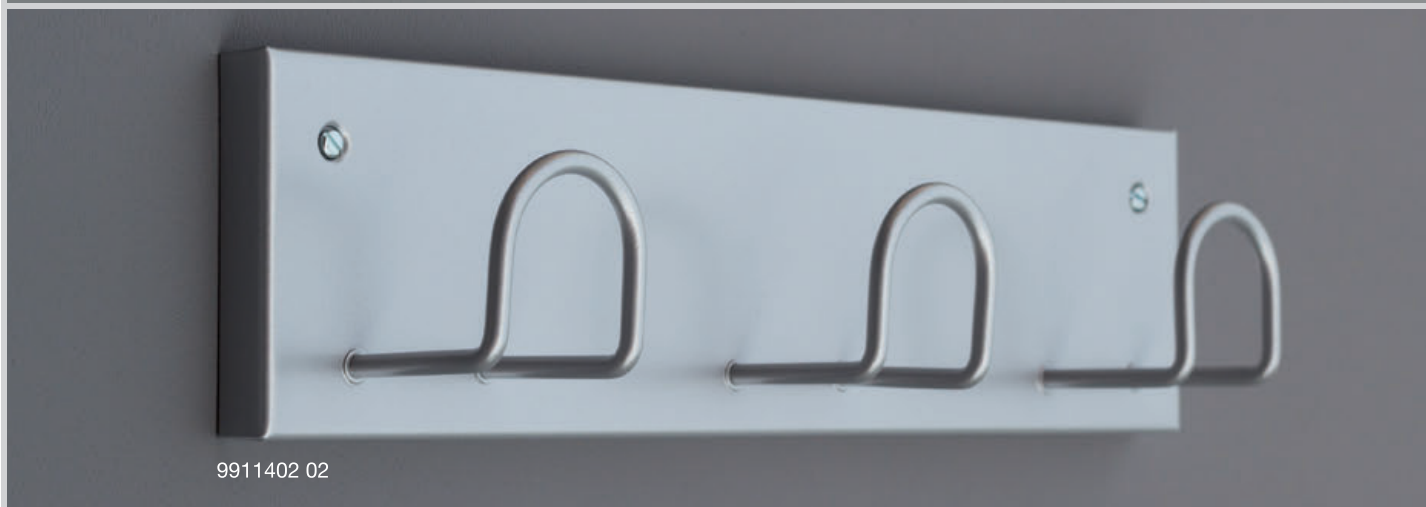

9911402 02

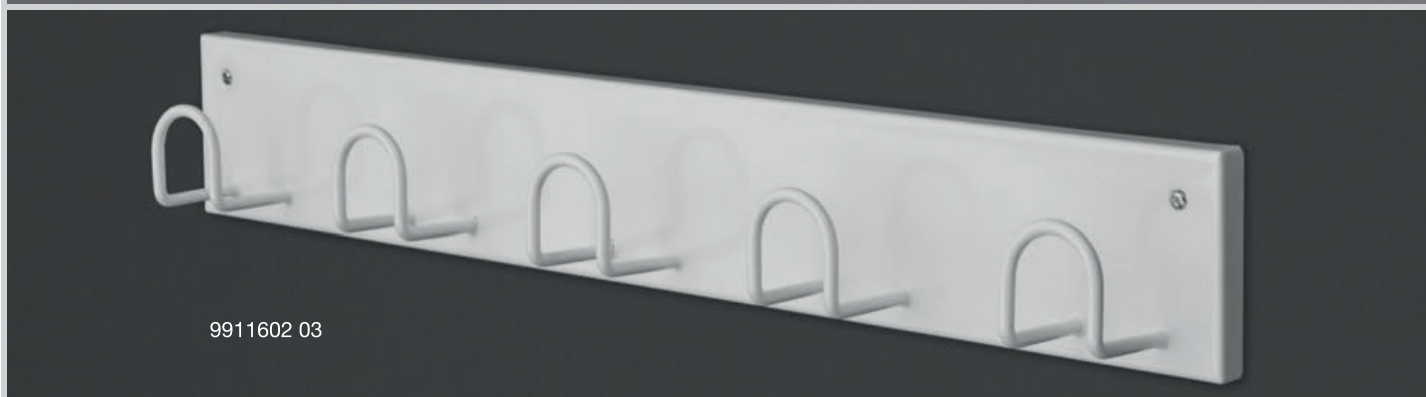

9911602 03

ES Percha de pared metálica con 3, 4 5 y 6 colgadores. Incluye accesorios para instalación.

EN Wall-mounted rack with 3, 4, 5 and 6 hooks. Accessories included.

FR Portemanteau mural métallique avec 3, 4, 5 et 6 patères. Les accessoires pour l'installation sont inclus.

DE Wandhaken aus Metall mit 3, 4, 5 und 6 Kleiderbügel. Enthält Zubehör zur Installation an Wänden.

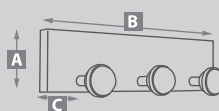
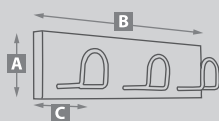

	A	B	C	
Ref. 9911402_	10 cm	39,5 cm	7,5 cm	3
Ref. 9911502_	10 cm	54,5 cm	7,5 cm	4
Ref. 9911602_	10 cm	69,5 cm	7,5 cm	5

02 03

	A	B	C	
Ref. 9911302	10 cm	39,5 cm	9,5 cm	3
Ref. 996602	10 cm	79,5 cm	9,5 cm	6

01 02 03

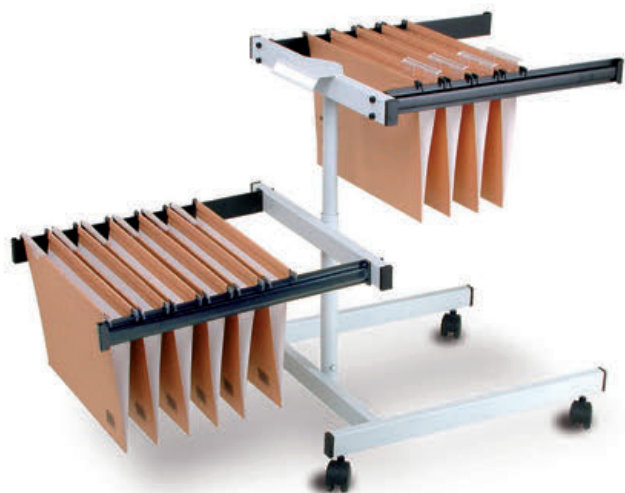



890202



890201

ES Carrito móvil de 7 bandejas extraíbles con porta etiquetas, estructura y bandejas fabricadas en metal. Se entrega montado.

EN Moveable trolley with 7 removable trays, with label holders, metal frame and trays. Delivered fully assembled.

FR Chariot mobile de 7 plateaux extractibles avec porte-étiquettes, structure et plateaux fabriqués en métal. Livré monté.

DE Mappenwagen mit Rollen, sieben abnehmbaren Ablagen und Etikettenhalter, Rahmen und Ablagen aus Metall. Wird montiert geliefert.

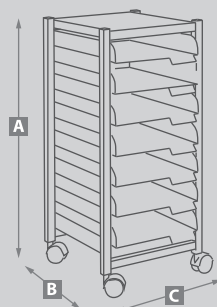

	A	B	C
Ref. 890202	66 cm	34,5 cm	30 cm
Ref. 890201	66 cm	34,5 cm	30 cm



887829



877829



880402



870402

ES Mesa auxiliar móvil de estructura metálica, con 2 y 3 estantes de madera melaminados en color haya de 19 mm. de espesor. Pintado en color plata.
Mesa auxiliar móvil de estructura metálica, con Estantes metálicos fabricados en chapa perforada.

EN Moveable side table with metal frame, 2 or 3 beech-coloured wooden melamine shelves and a thickness of 19 mm. Painted silver.
Moveable side table with metal frame, Perforated metal shelves.

FR Table auxiliaire mobile, structure métallique, composée de 2 et 3 rangées en bois mélaminées couleur hêtre, de 19 mm d'épaisseur. Peinte en argent. Table auxiliaire mobile, structure métallique, Rangées métalliques fabriquées en plaque perforée.

DE Beistelltisch mit Rollen, Metallrahmen mit 2 und 3 Melamin Ablagen in Buche 19 mm dick. In Silber.
Beistelltisch mit Rollen, Metallfächer hergestellt aus perforiertem Blech.

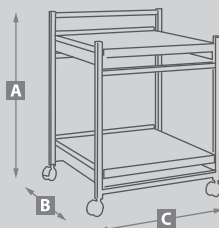

	A	B	C
Ref. 877829	66 cm	45,5 cm	50 cm
Ref. 887829	74 cm	45,5 cm	50 cm
Ref. 870402	65,5 cm	45,5 cm	50 cm
Ref. 880402	81 cm	45,5 cm	50 cm



10091 02



10092 03



10093 03

Carro para carpetas colgantes medida folio.
NO INCLUYE CARPETAS

Trolley for hanging document measure sheet.
FOLDERS NOT INCLUDED

Chariot pour dossiers suspendus mesure folio.
DOSSIERS NON INCLUS

Hängeaktenwagen.
ORDNER NICHT ENTHALTEN

ES Carro para carpetas de estructura metálica, con uno o dos niveles fijos y uno giratorio 360 grados.

EN Two or Three-tier metal frame folder trolley, with one or two fixed tiers and one 360 degree revolving tier.

FR Chariot pour dossiers, structure métallique, avec deux ou trois niveaux, une ou deux fixes et un pivotant à 360 degrés.

DE Hängeaktenwagen mit Metallrahmen, mit zwei oder drei Ebenen, ein oder zwei fixiert und eine um 360° drehbar.

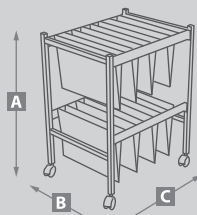

Ref.	A	B	C	
10091_	66,5 cm	40 cm	50 cm	80
01	02	03		

Ref.	A	B	C	
10092_	65 cm	45 cm	48 cm	80
02	03			

Ref.	A	B	C	
10093_	96,5 cm	45 cm	48 cm	120
02	03			



*Quiero dedicar este proyecto, a una de las personas más importantes en mi vida, mi padre José Arumí Roura.
Por el apoyo, cariño, comprensión y confianza en mí, pero sobre todo por haberme ayudado a formar la persona que hoy en día soy.
Allí donde estás quiero que sepas que "quererte fue fácil, olvidarte imposible".*

*I want to dedicate this project to one of the most important persons in my life, my father José Arumí Roura.
For your support, affection, comprehension and faith in me; but above all for helping me to become the person I am nowadays.
Wherever you are I want you to know: "loving you was easy, to forget you will be impossible".*

*Je veux dédier ce projet à une des personnes les plus importantes dans ma vie, mon père José Arumí Roura.
Pour son soutien, amour, compréhension et confiance en moi, mais surtout pour m'avoir aidé à devenir la personne que je suis aujourd'hui.
Là où tu sois, je veux que tu saches que "t'aimer fut facile, t'oublier impossible".*

*Dieses Projekt möchte ich einer der wichtigsten Personen in meinem Leben widmen: meinem Vater José Arumí Roura.
Für die Unterstützung, Zuneigung, Verständnis und Vertrauen in mich; insbesondere aber für deine Hilfe, um mich zu der Person zu machen, die ich heute bin.
Wo immer du auch bist, möchte ich dir sagen: „dich zu lieben war einfach, dich zu vergessen unmöglich“.*



sistemasdavid.com

Distribuido por: / Distribute by: / Distribué par: / Vertreten durch: