

ARTÍCULOS PARA LA PROTECCIÓN DEL CORONAVIRUS
ARTICLES FOR THE PROTECTION OF CORONAVIRUS
ÉLÉMENTS DE PROTECTION CONTRE LE CORONAVIRUS
ARTIKEL ZUM SCHUTZ DES CORONAVIRUS

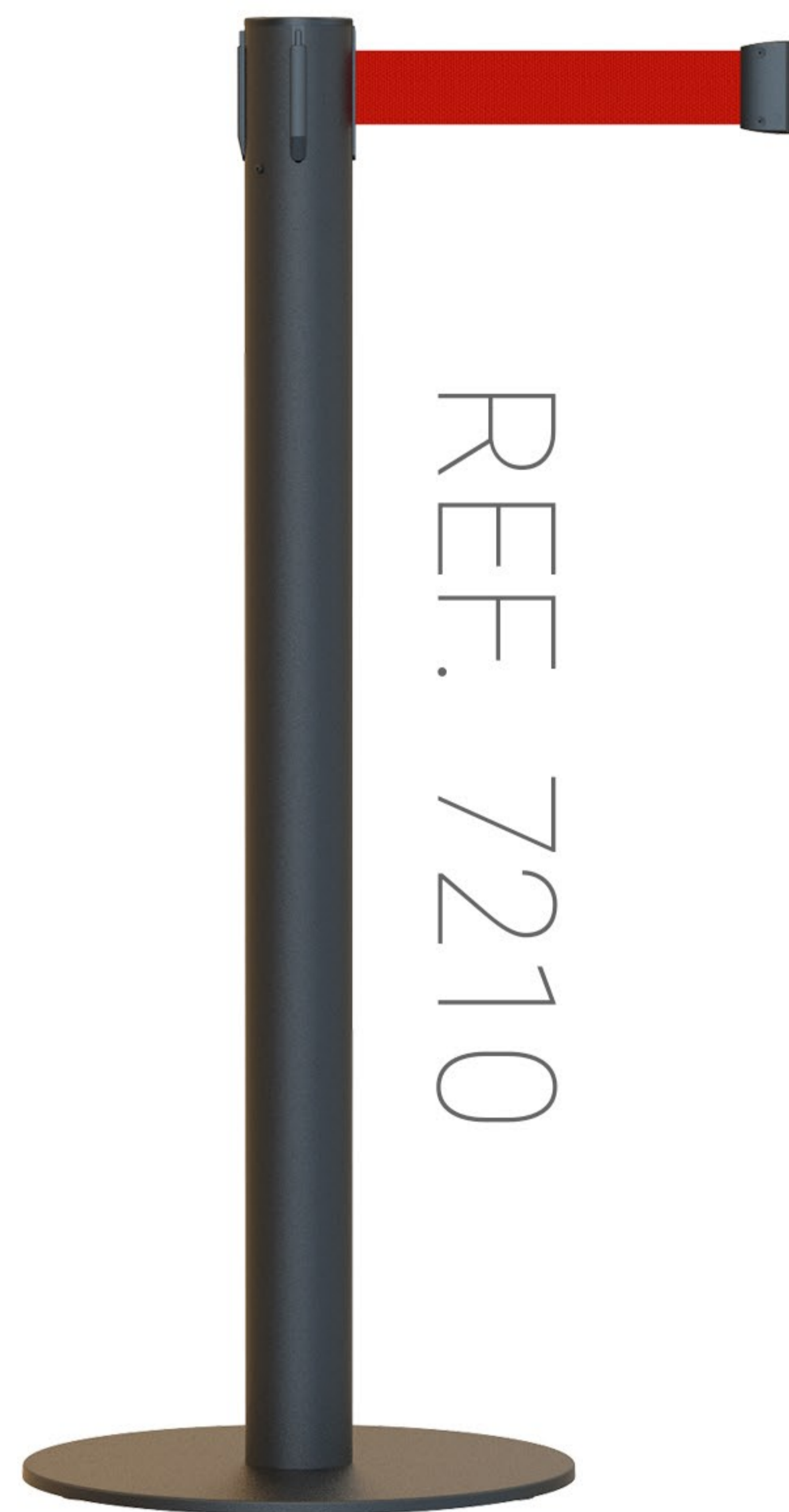

REF. 7210

 CINTA PERSONALIZADA



 BENUTZERDEFINIERTE BÄNDER

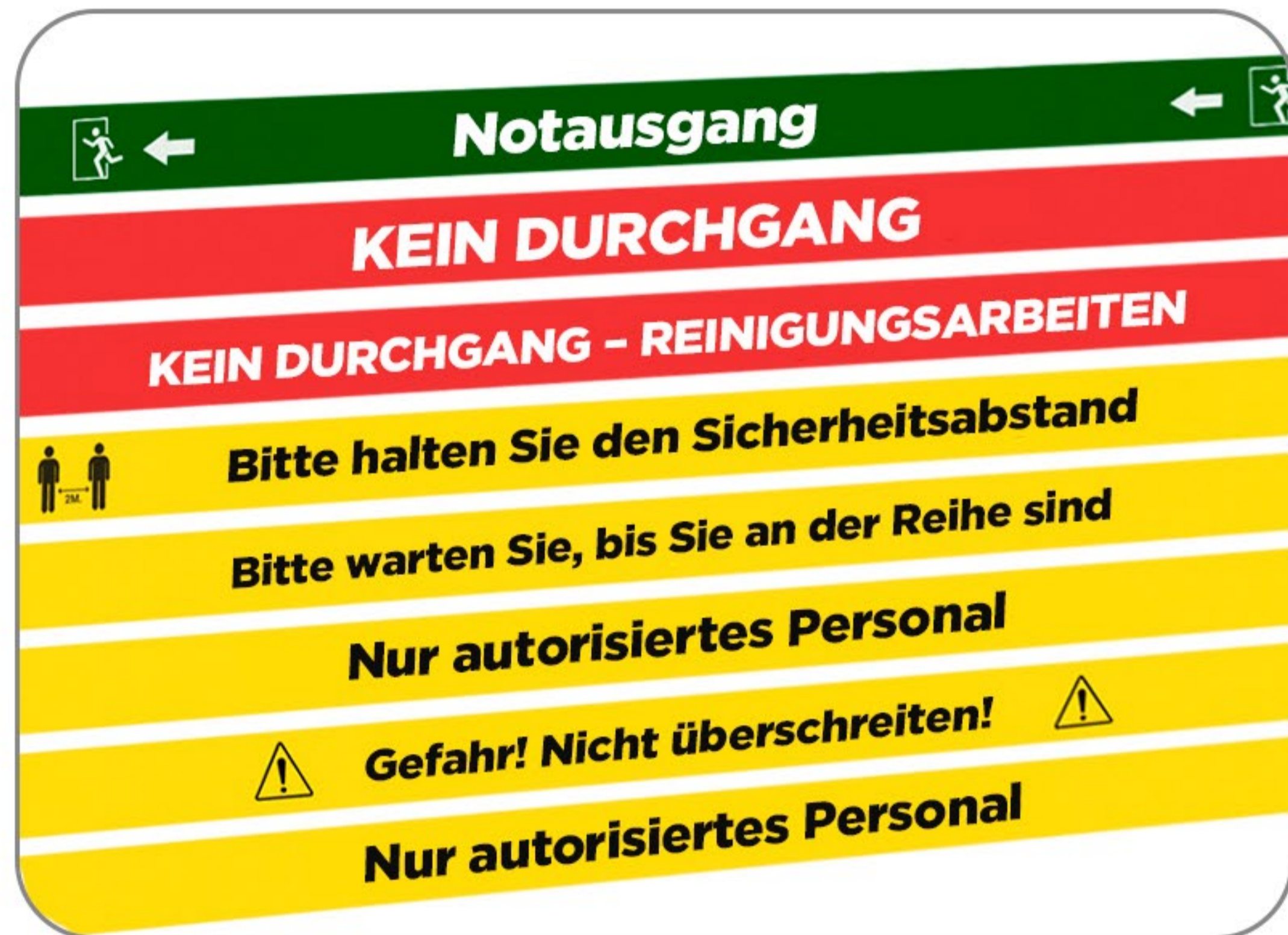

 RUBANS PERSONNALISÉS



 PERSONALIZED RIBBONS



COLORES / COLOURS / COULEURS / FARBEN



COLORES / RIBBONS / RUBANS / BÄNDER

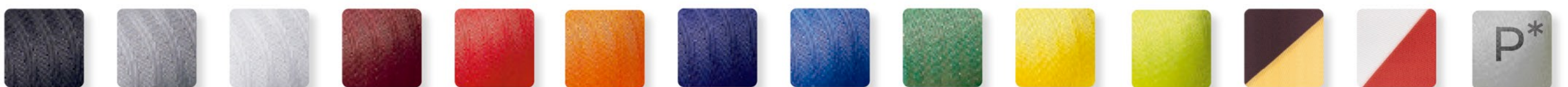

11,25€/m

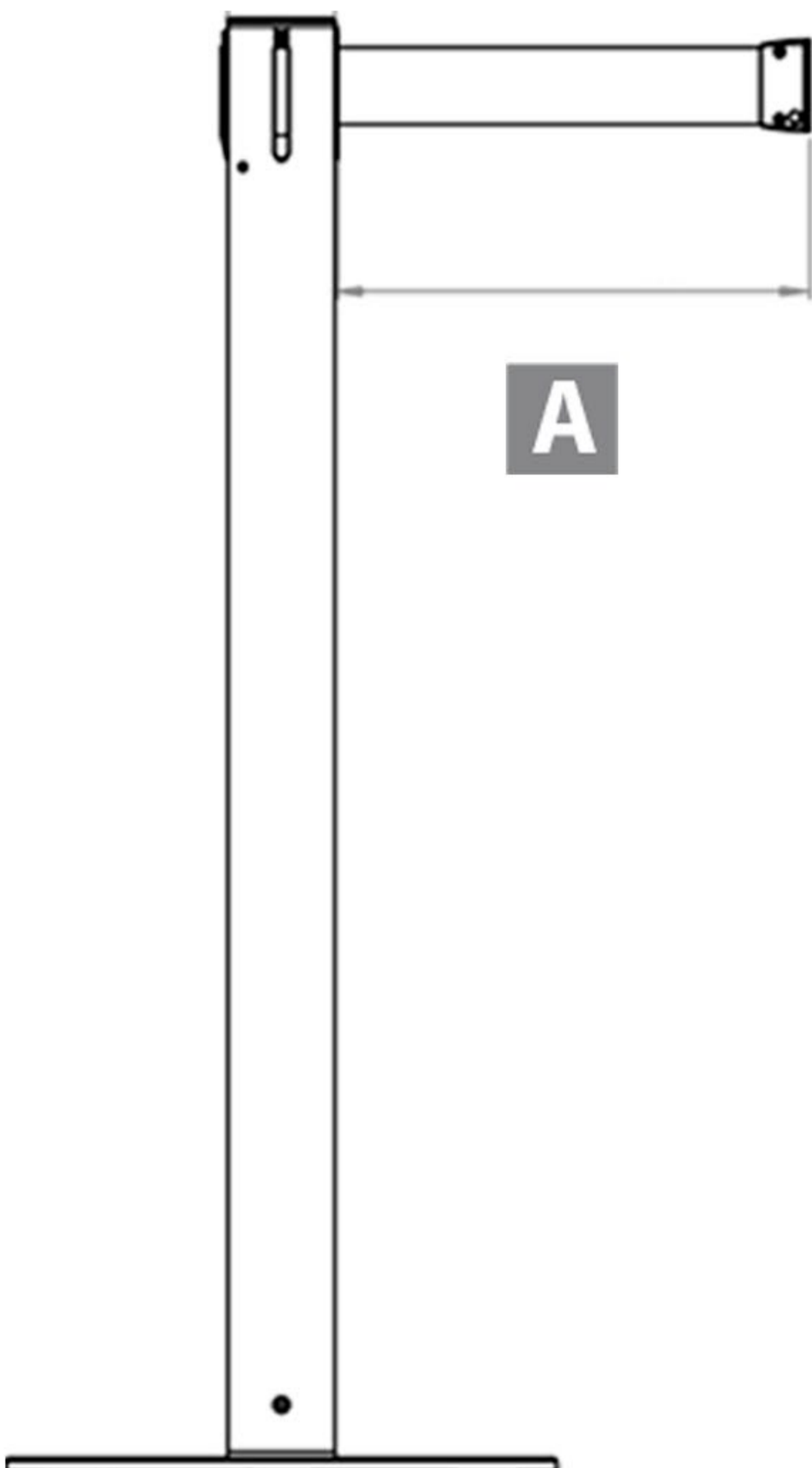

A	Kg	€
7210 2m	11.00 Kg	75,40 €
7210 3m	8.00 Kg	86,00 €
7210 4m	8.00 Kg	94,60 €
7210 5m	8.00 Kg	110,00 €

A	€
	12,15 €
	73,00 €

* Cintas personalizadas / Personalized Ribbons / Rubans personnalisés / Benutzerdefinierte Bänder



	11,25 €/m
	11,25 €/m
	11,25 €/m
	11,25 €/m
	11,25 €/m
	11,25 €/m
	11,25 €/m
	11,25 €/m





REF. 7310

 CINTA PERSONALIZADA



 BENUTZERDEFINIERTE BÄNDER

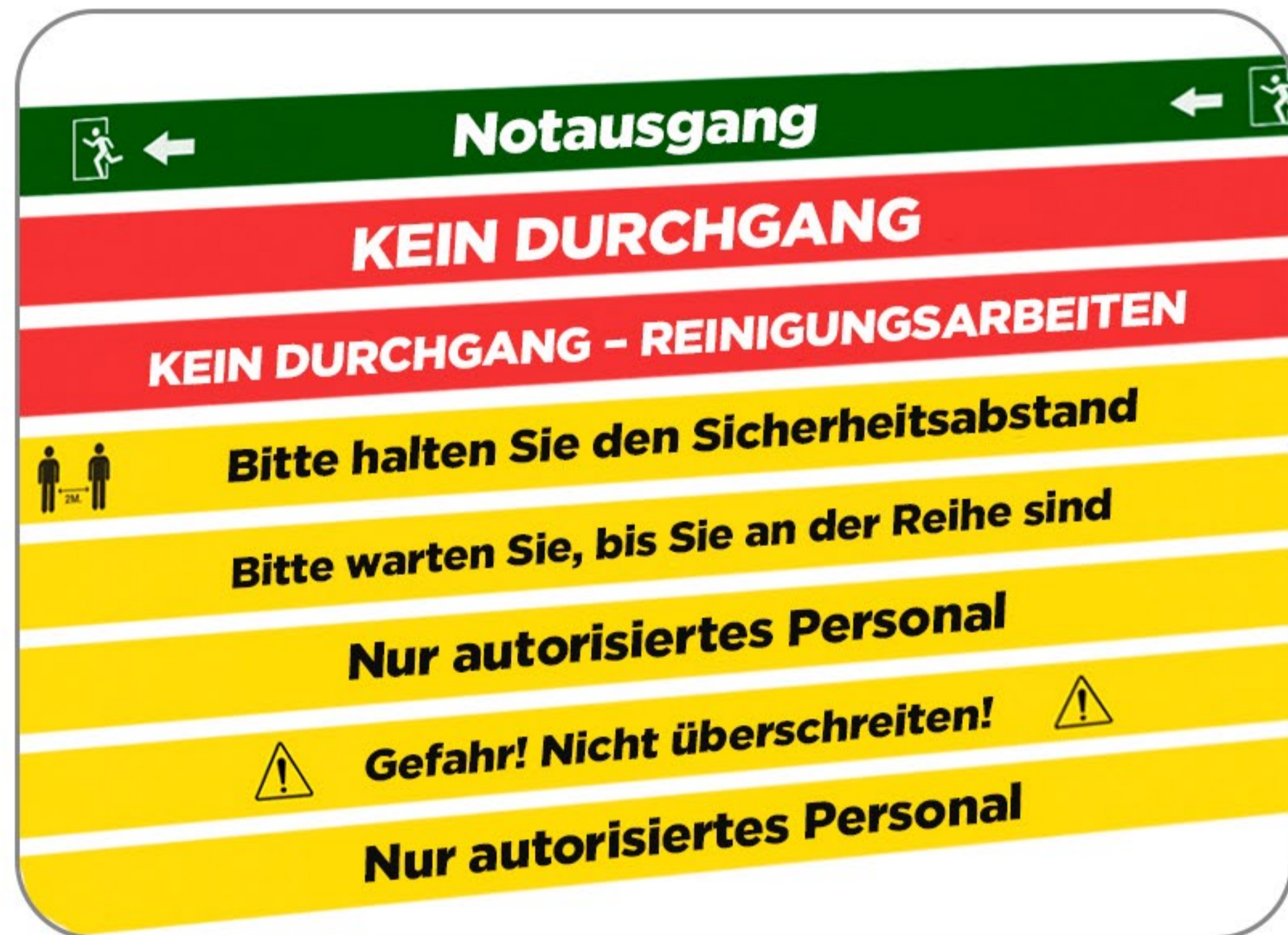

 RUBANS PERSONNALISÉS



 PERSONALIZED RIBBONS



COLORES / COLOURS / COULEURS / FARBEN



COLORES / RIBBONS / RUBANS / BÄNDER



11,25€/m

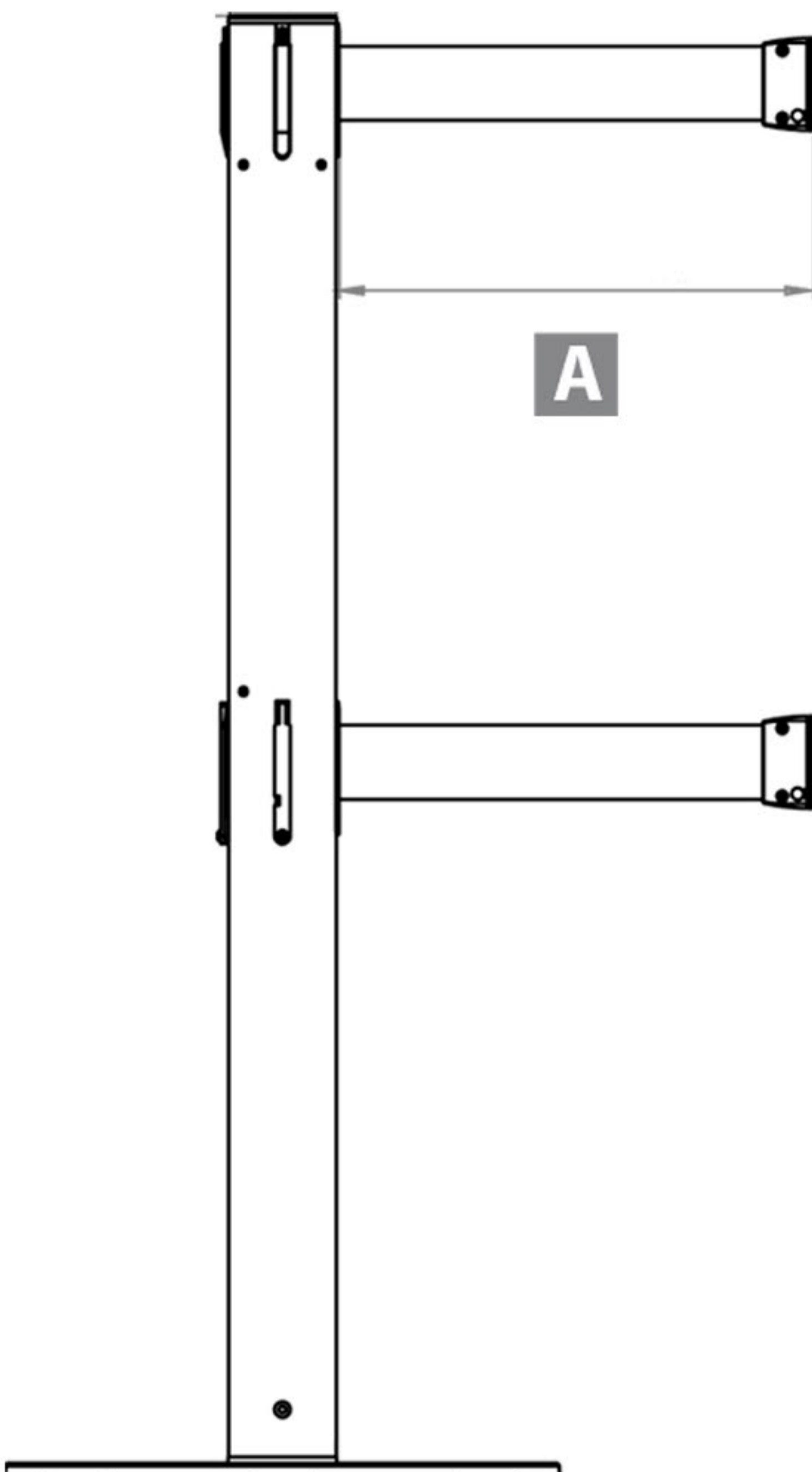

A	Kg	€
7310 2 Metros	11.00 Kg	132,50 €
7310 2.5 Metros	11.00 Kg	134,80 €

A	€
	12,20 €
	130,70 €

* Cintas personalizadas / Personalized Ribbons / Rubans personnalisés / Benutzerdefinierte Bänder

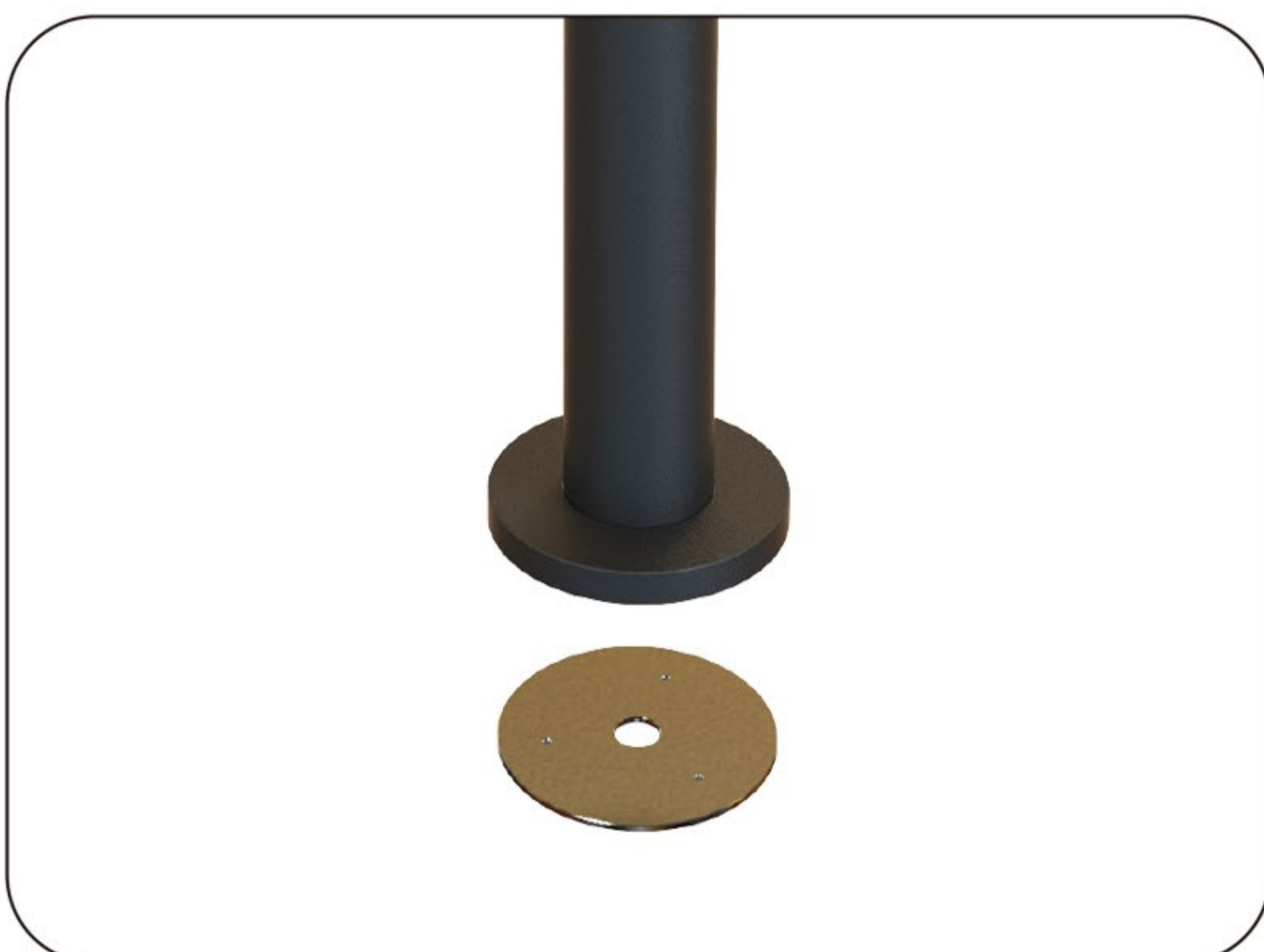

REF. 72101

 CINTA PERSONALIZADA



 BENUTZERDEFINIERTE BÄNDER

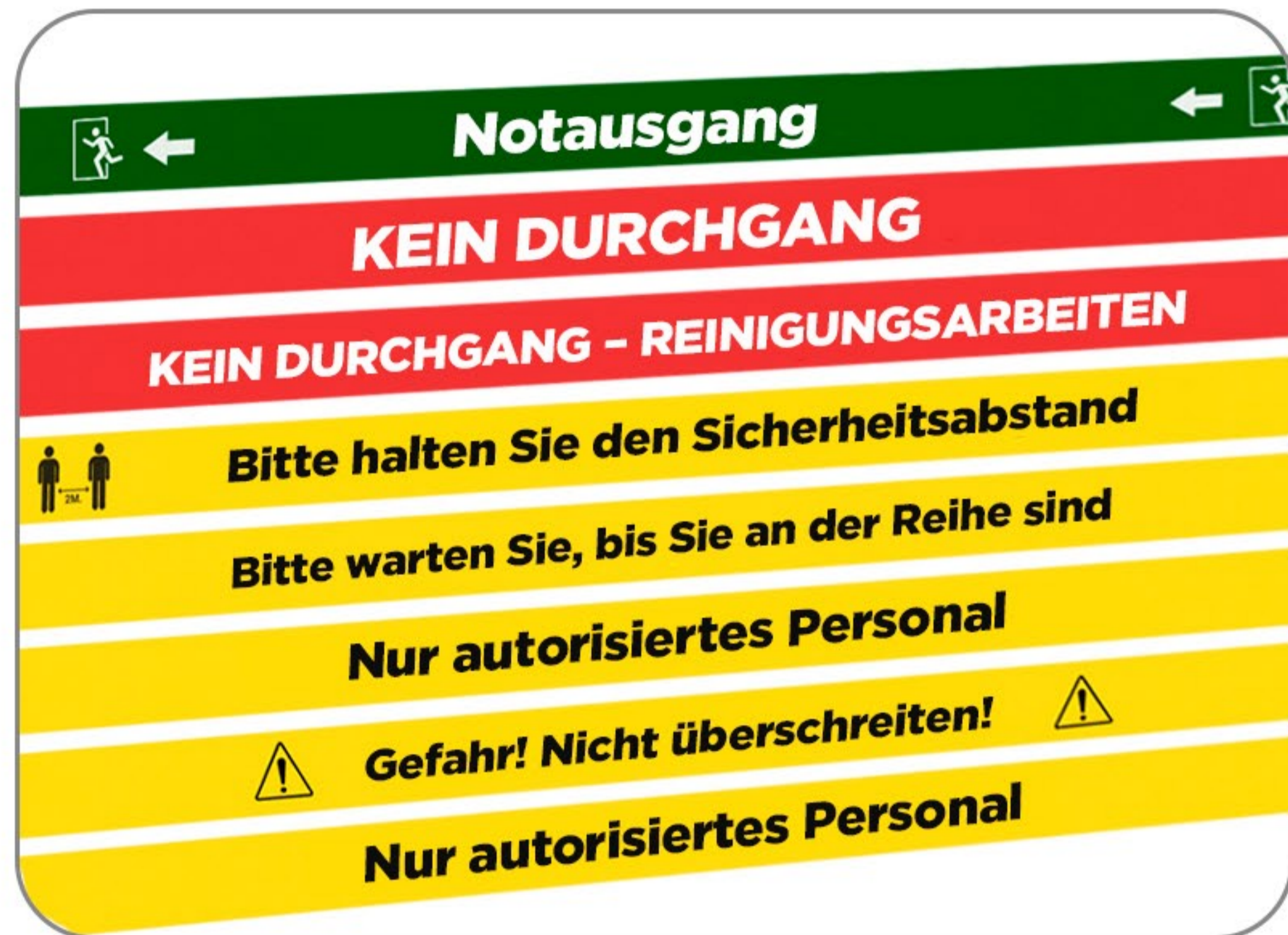

 RUBANS PERSONNALISÉS



 PERSONALIZED RIBBONS



COLORES / COLOURS / COULEURS / FARBEN



COLORES / RIBBONS / RUBANS / BÄNDER

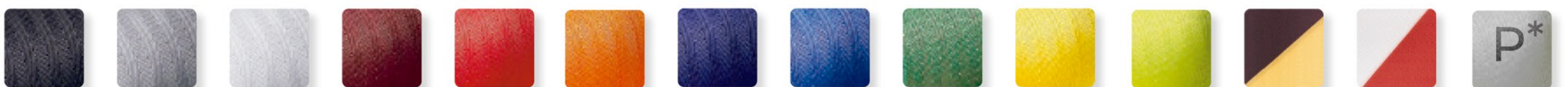

11,25€/m

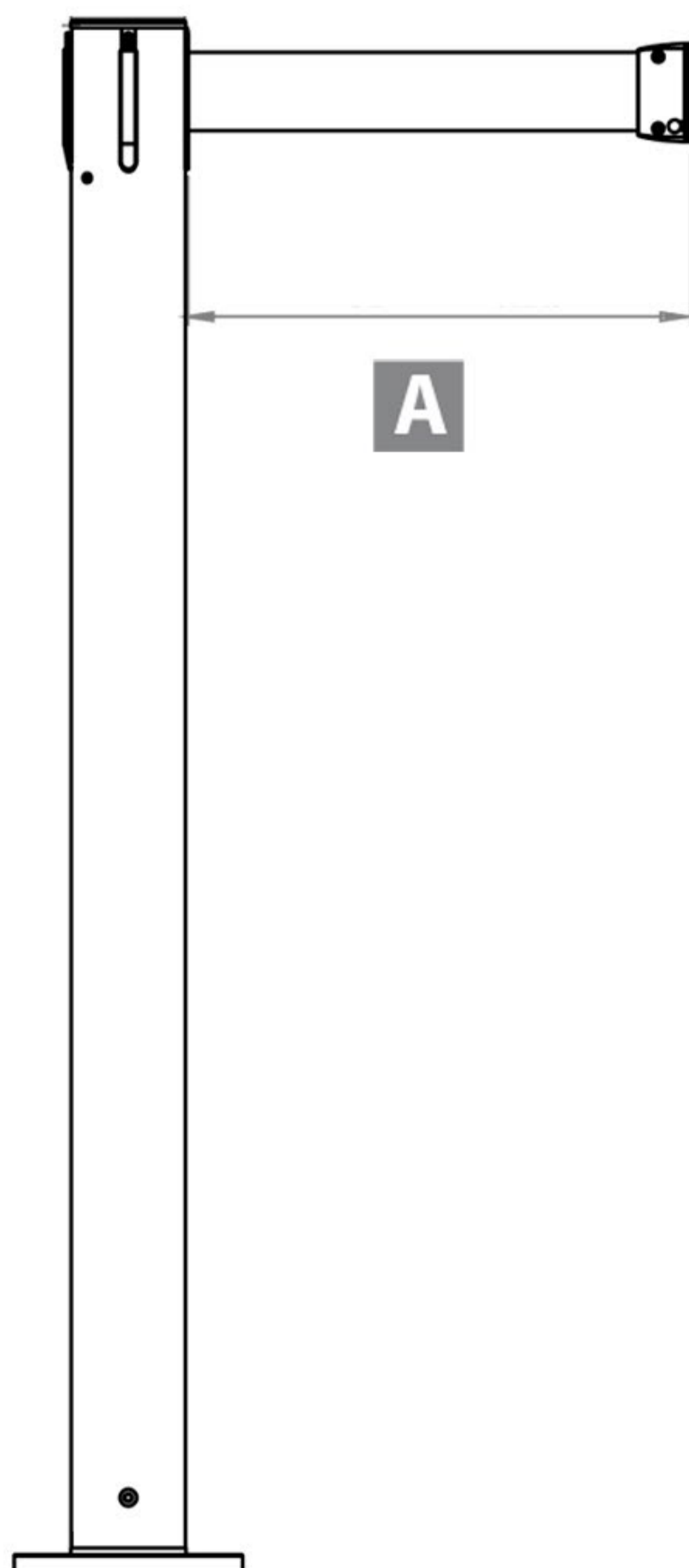

A	Kg	€
72101 2m	4.00 Kg	127,00 €
72101 3m	4.00 Kg	130,90 €
72101 4m	4.00 Kg	134,80 €
72101 5m	4.00 Kg	146,20 €

A	€
	12,20 €
	124,70 €

* Cintas personalizadas / Personalized Ribbons / Rubans personnalisés / Benutzerdefinierte Bänder

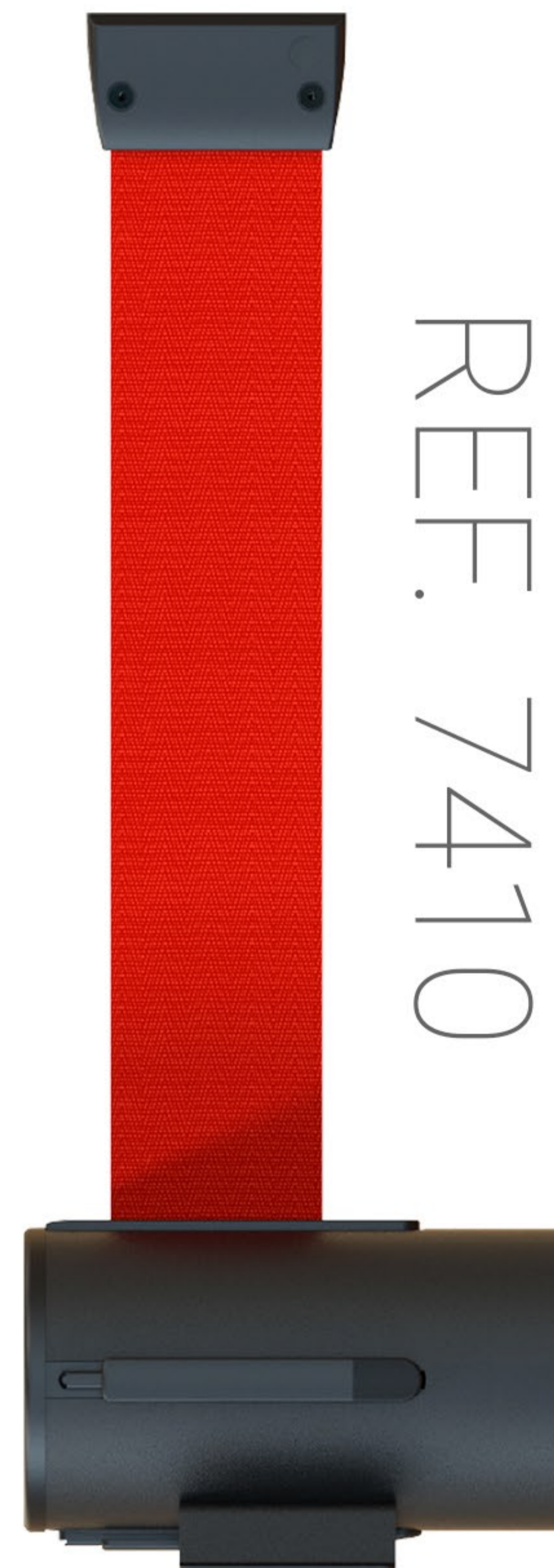
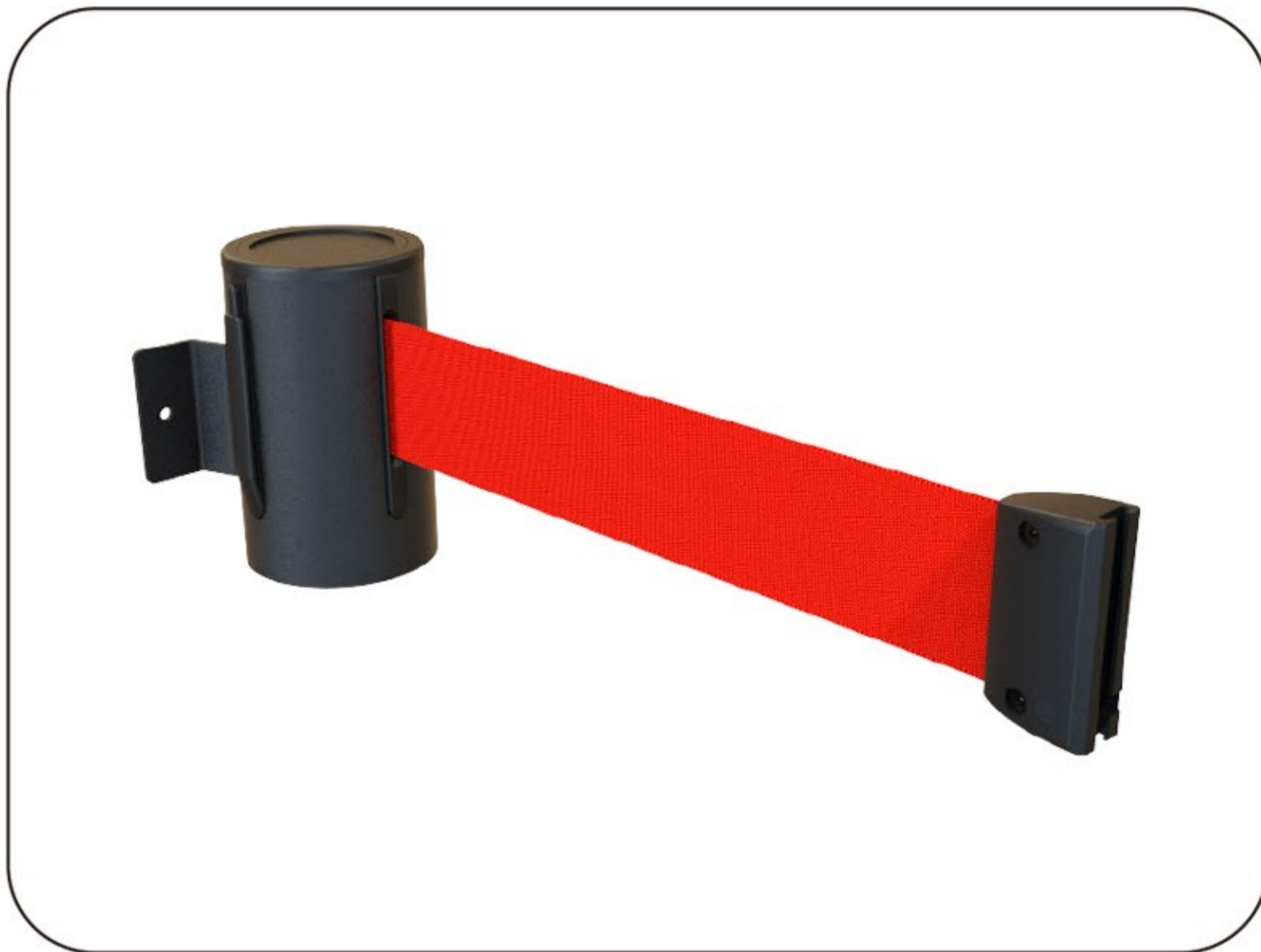

REF. 7410

 CINTA PERSONALIZADA



 BENUTZERDEFINIERTE BÄNDER

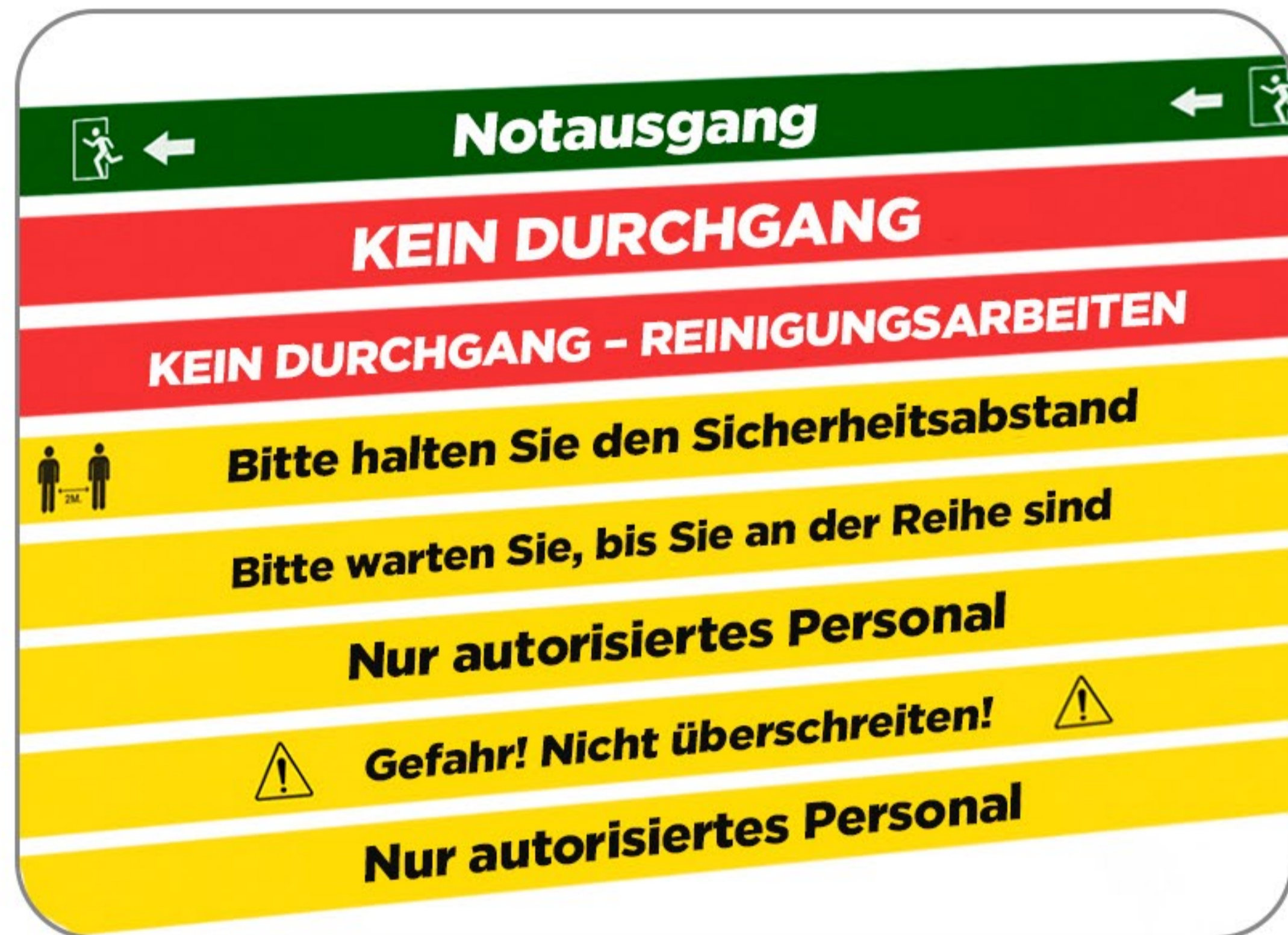

 RUBANS PERSONNALISÉS



 PERSONALIZED RIBBONS



COLORES / COLOURS / COULEURS / FARBEN



COLORES / RIBBONS / RUBANS / BÄNDER



11,25€/m

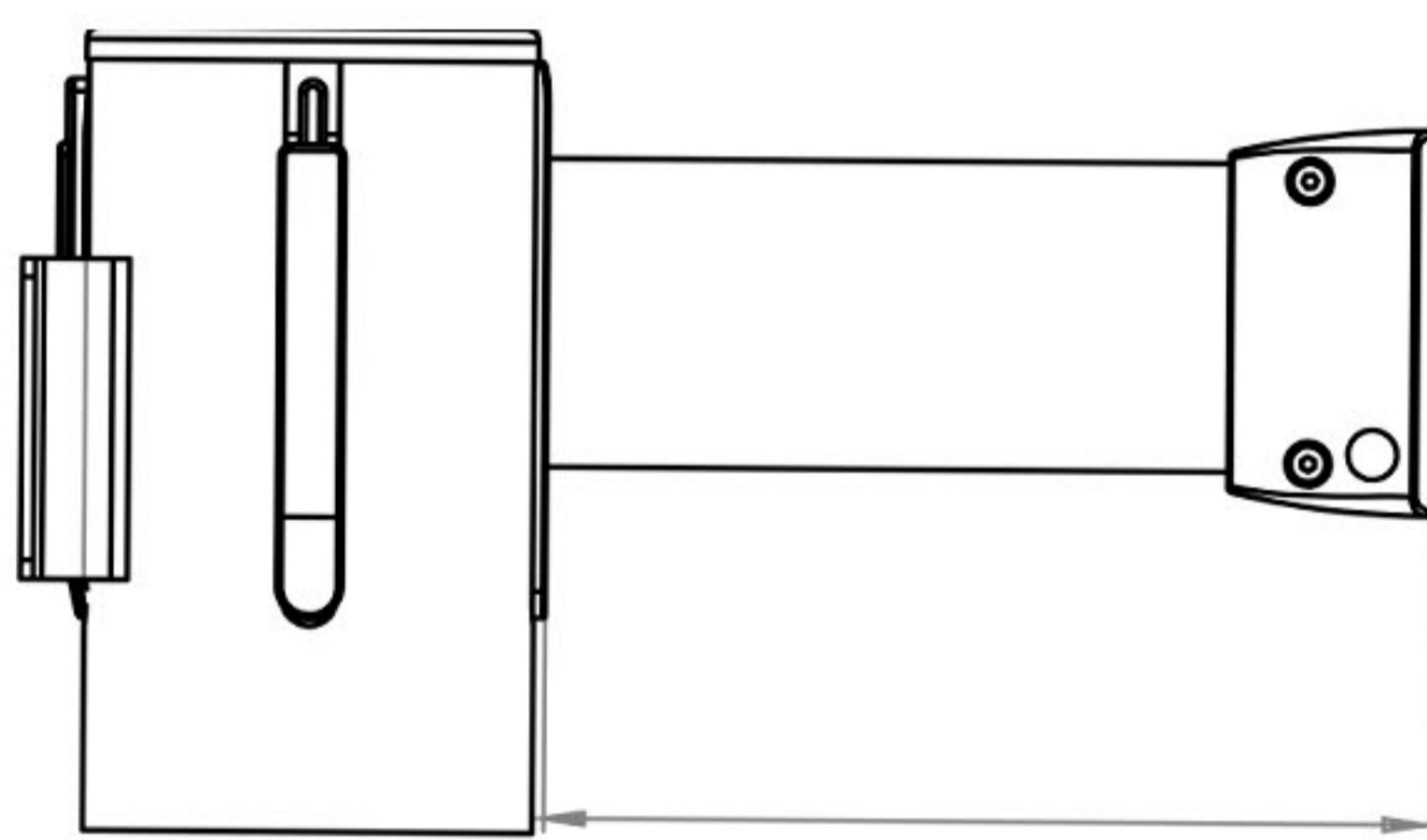

A

A	Kg	€
7410 2m	0.50 Kg	71,23 €
7410 3m	0.50 Kg	74,70 €
7410 4m	0.50 Kg	76,05 €
7410 5m	0.50 Kg	115,40 €

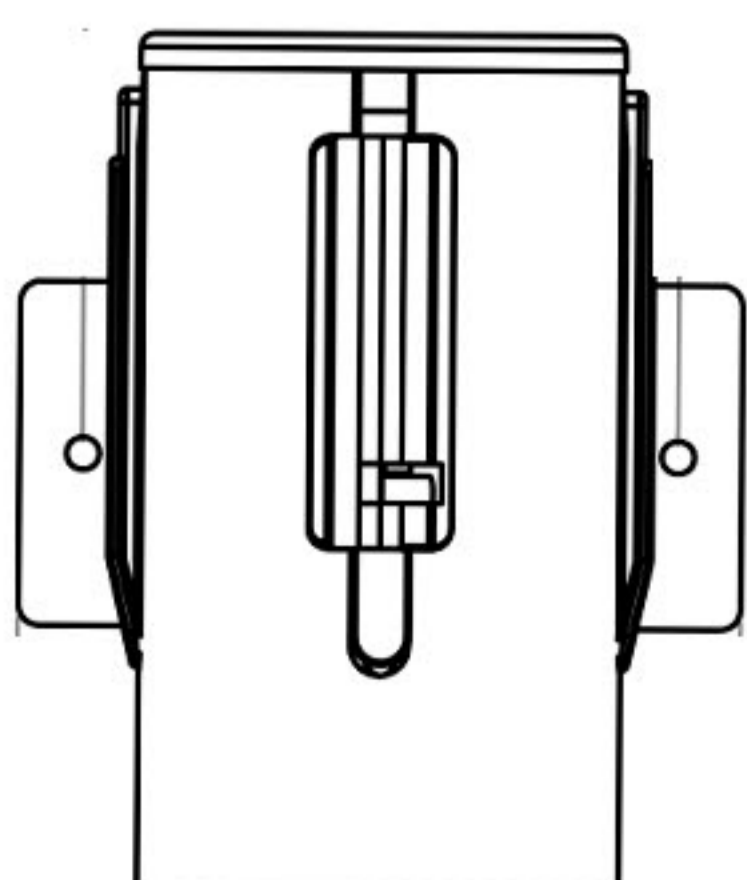

A

€



12,20 €



REF. 7510



 CINTA PERSONALIZADA



 BENUTZERDEFINIERTE BÄNDER

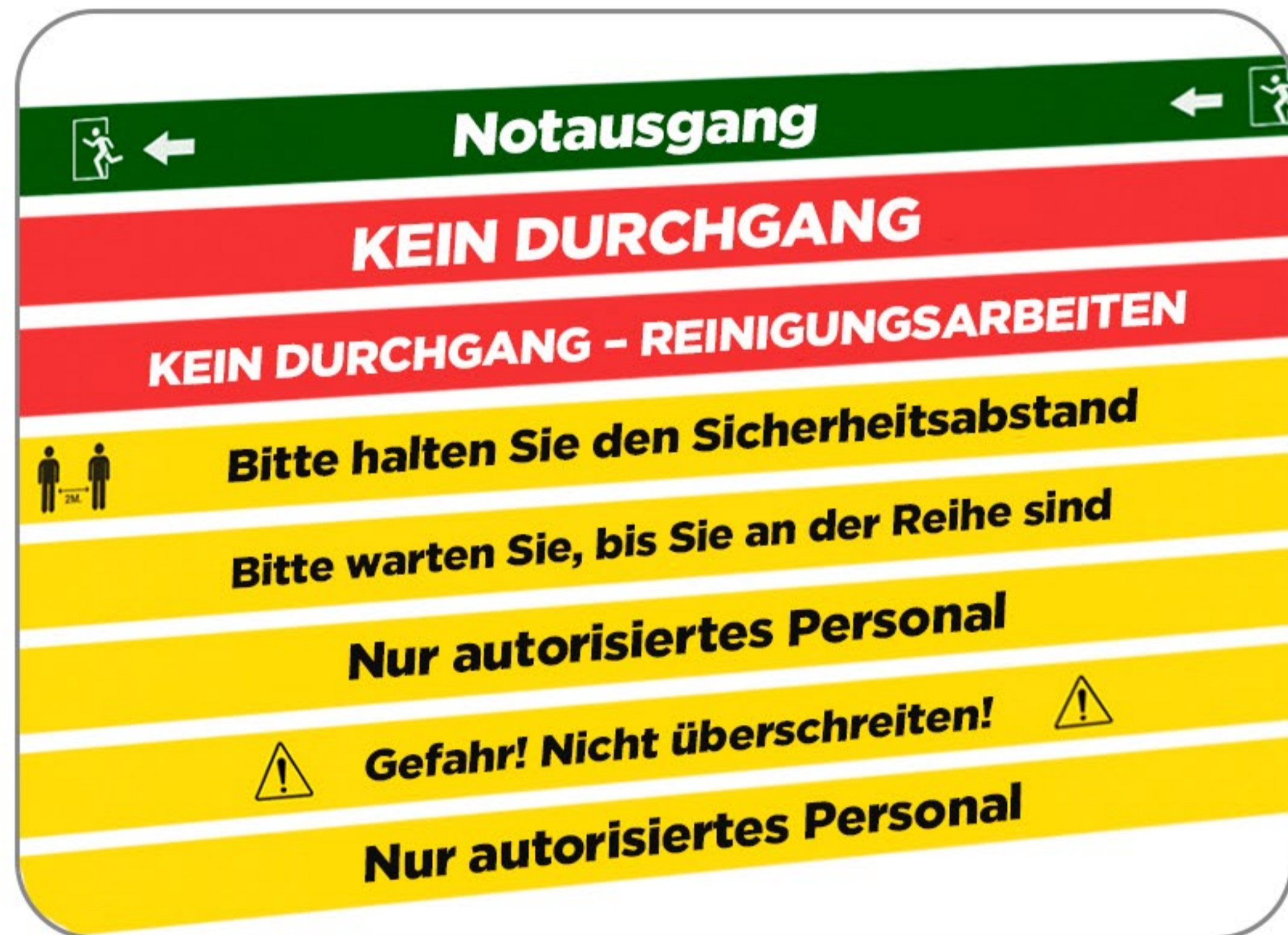

 RUBANS PERSONNALISÉS



 PERSONALIZED RIBBONS



COLORES / RIBBONS / RUBANS / BÄNDER



11,25€/m

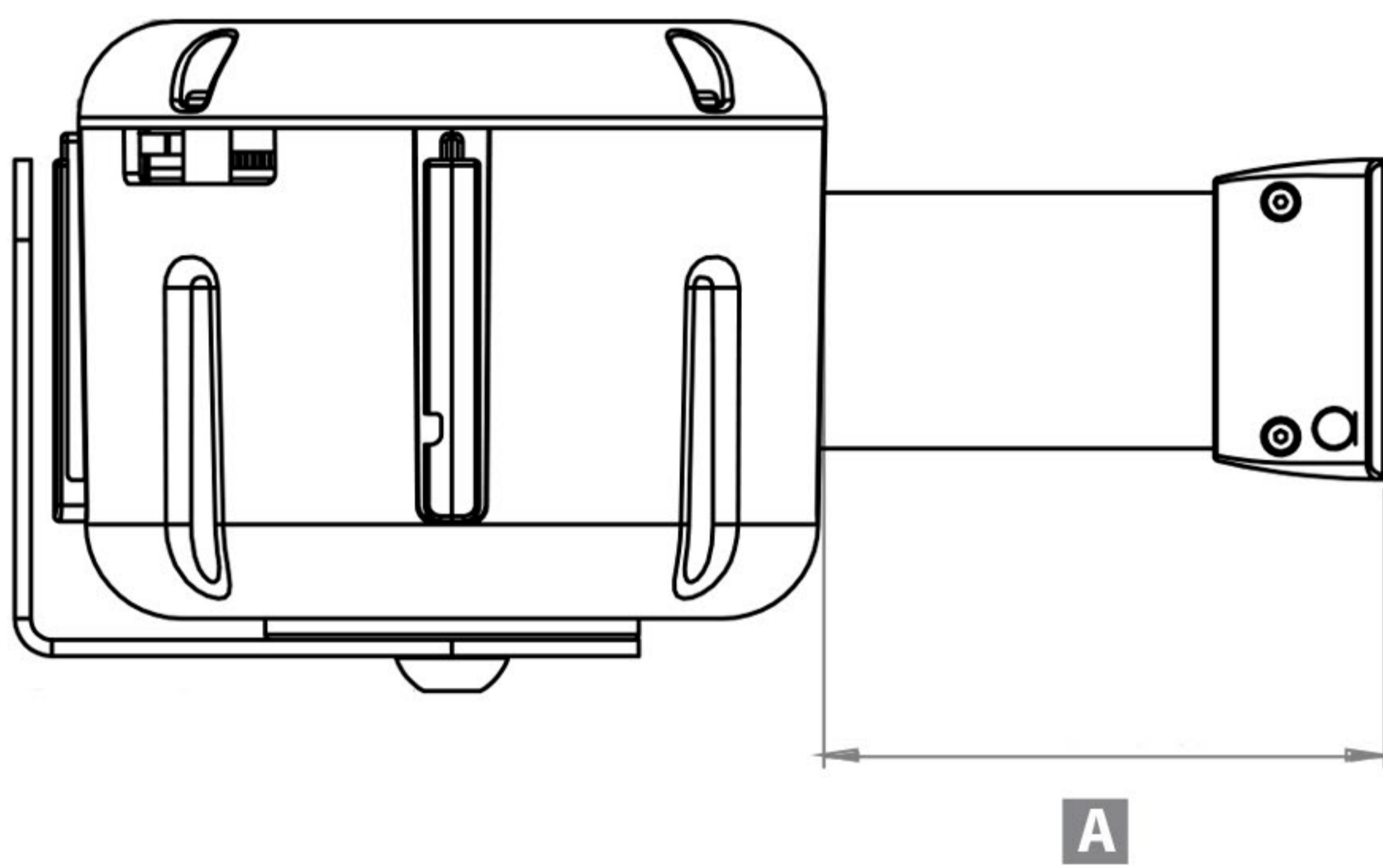

A	€
7510 7m	133,05 €

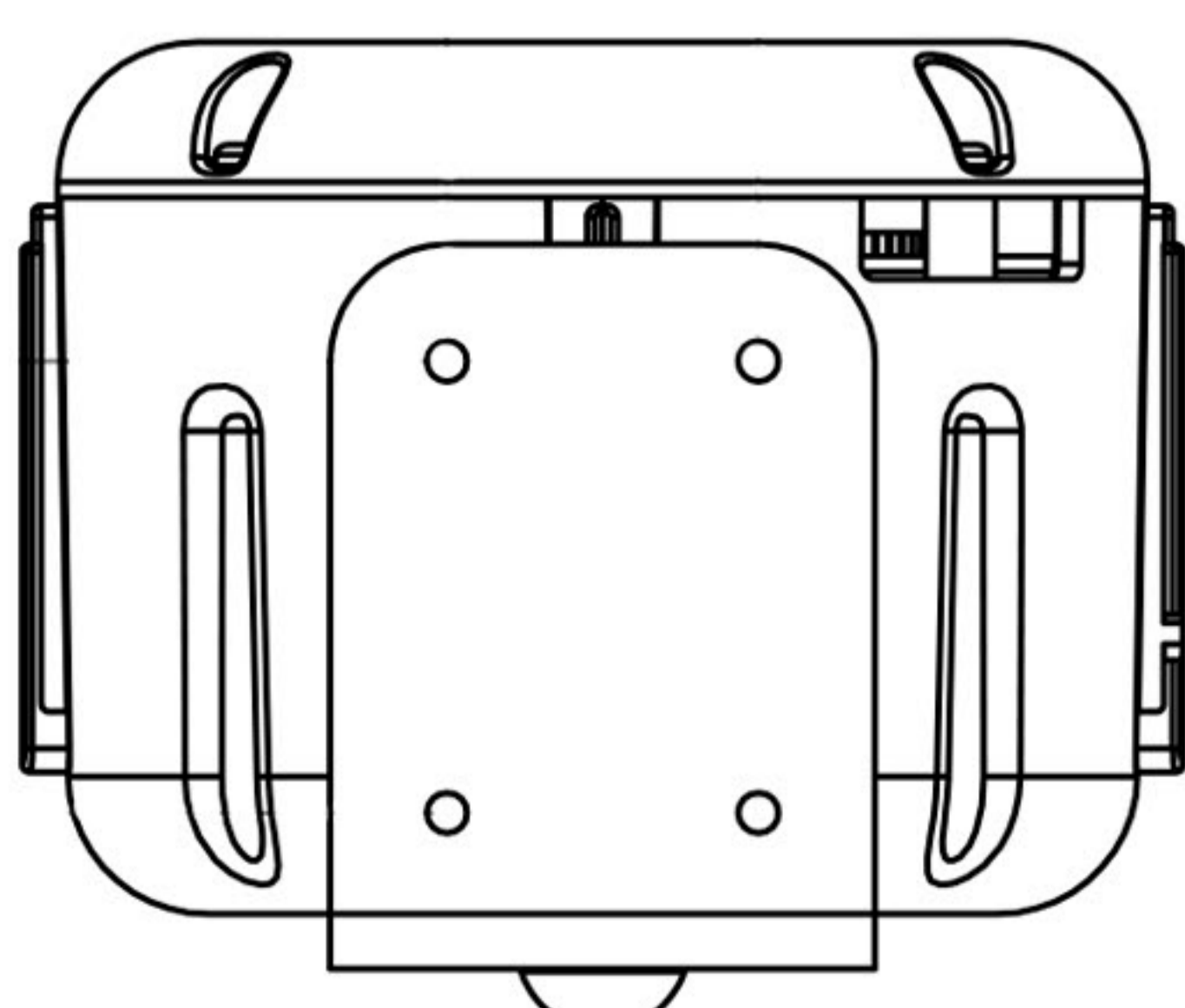

A	€
	12,20 €

* Cintas personalizadas / Personalized Ribbons / Rubans personnalisés / Benutzerdefinierte Bänder



REF. 73109

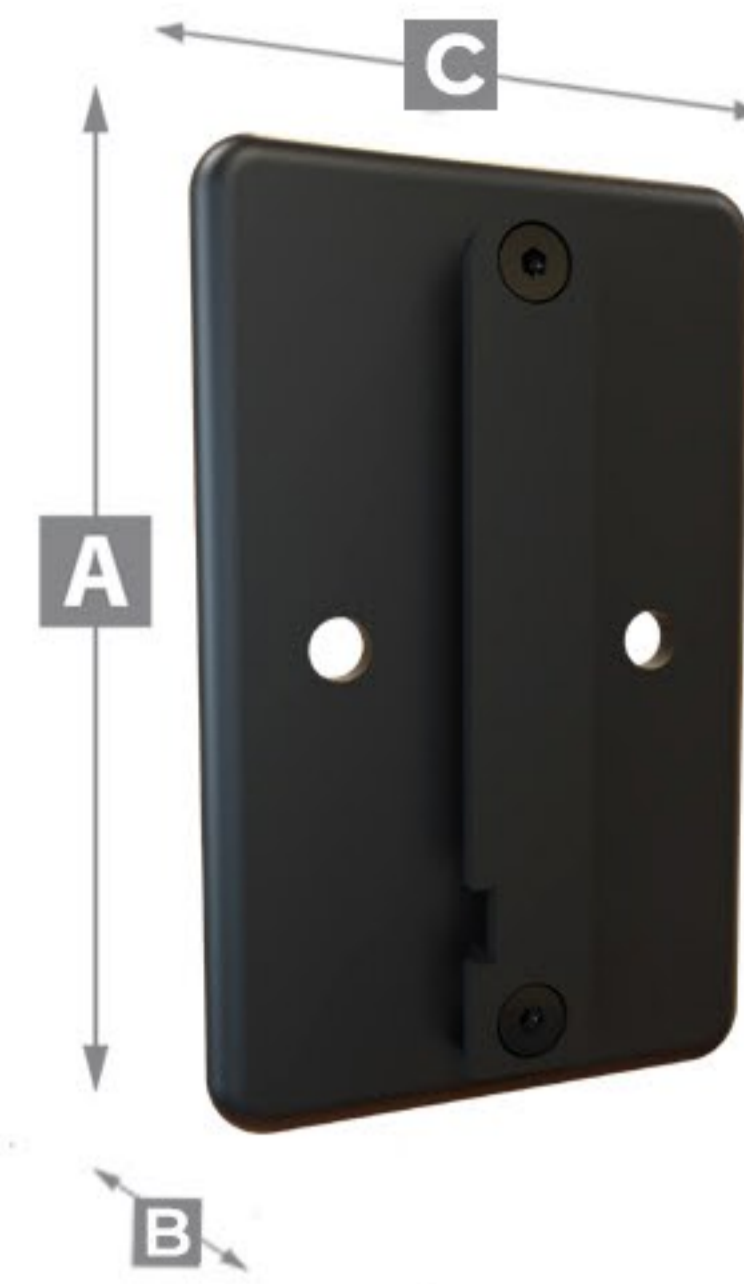

A	7,2 cm
B	4 cm
C	0,8 cm
Kg	0,05 kg
€	15,00 €

A	35cm
B	20cm
Kg	1kg
€	57,90 €

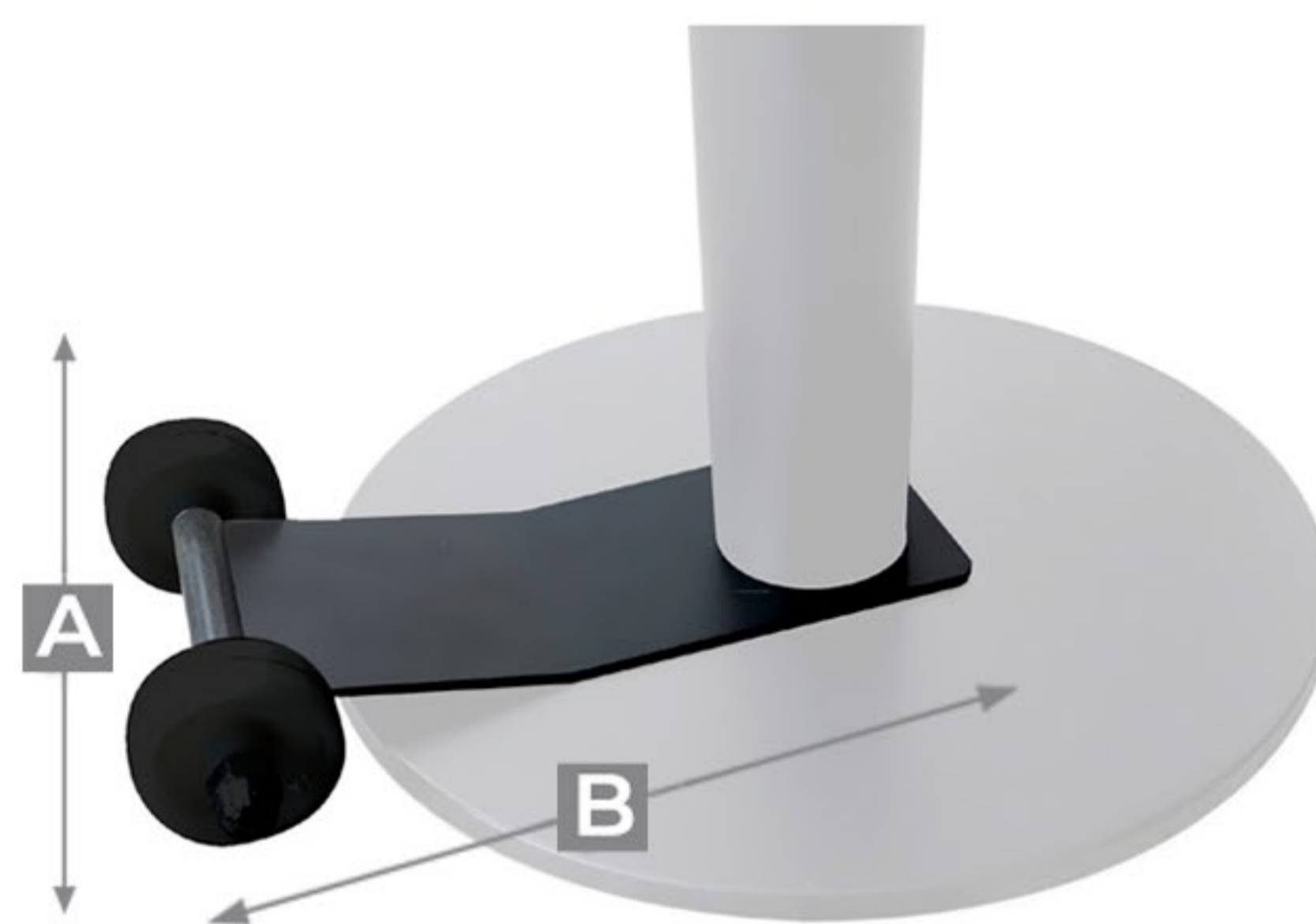

REF. 73109R

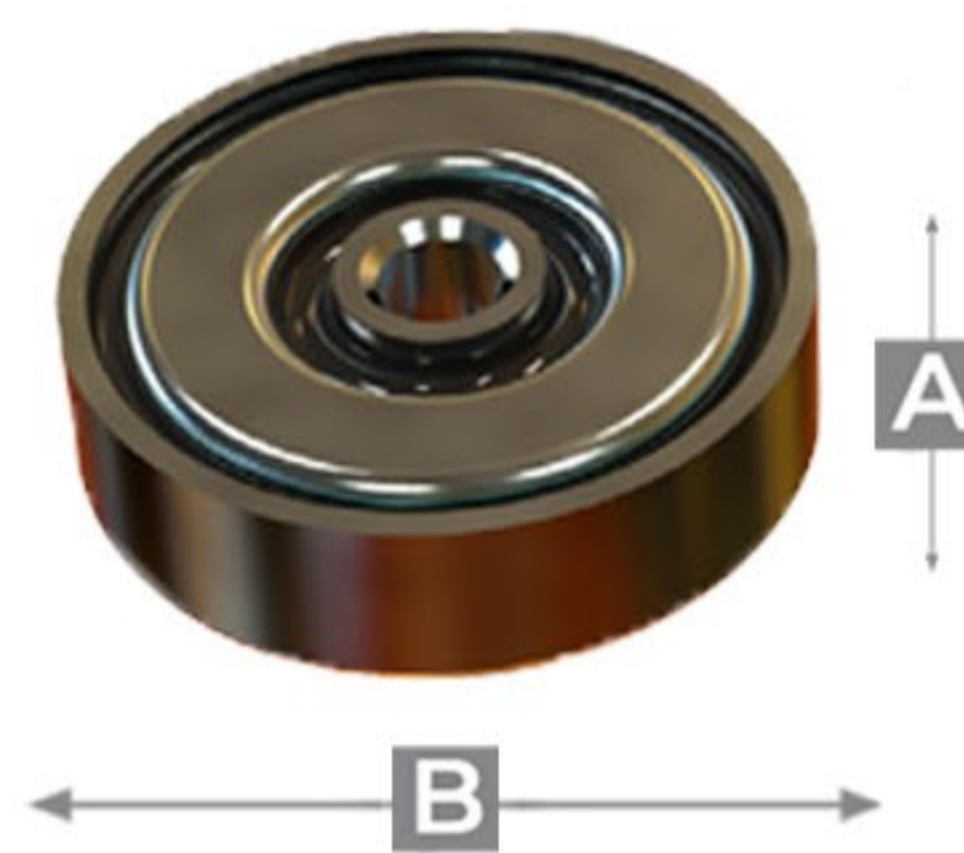

A	0,7 cm
B	2,5 cm ø
Kg	0,21 kg
€	79,75 €

A	0,4 cm
B	1,6 cm ø
Kg	0,05 kg
€	31,60 €

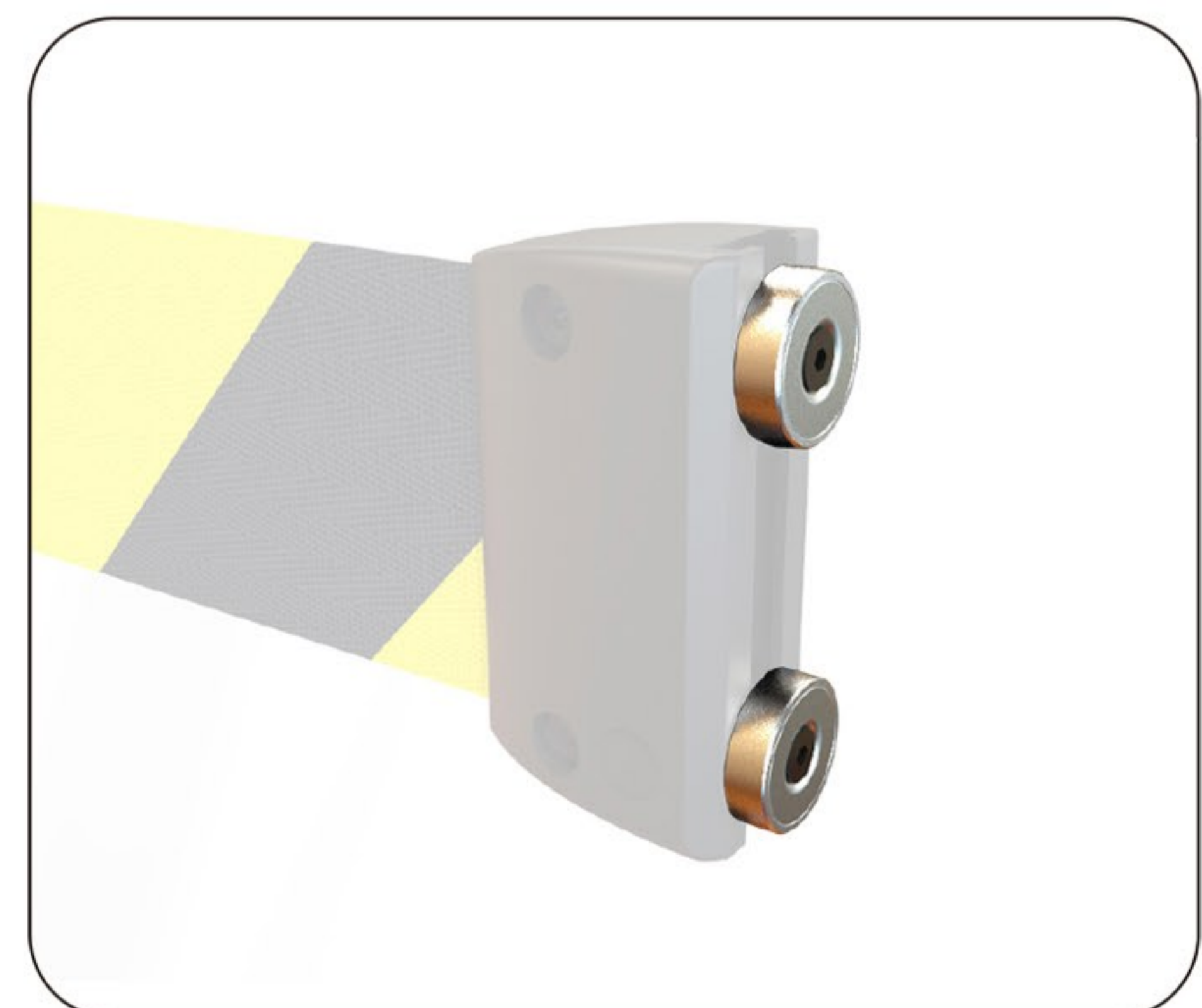
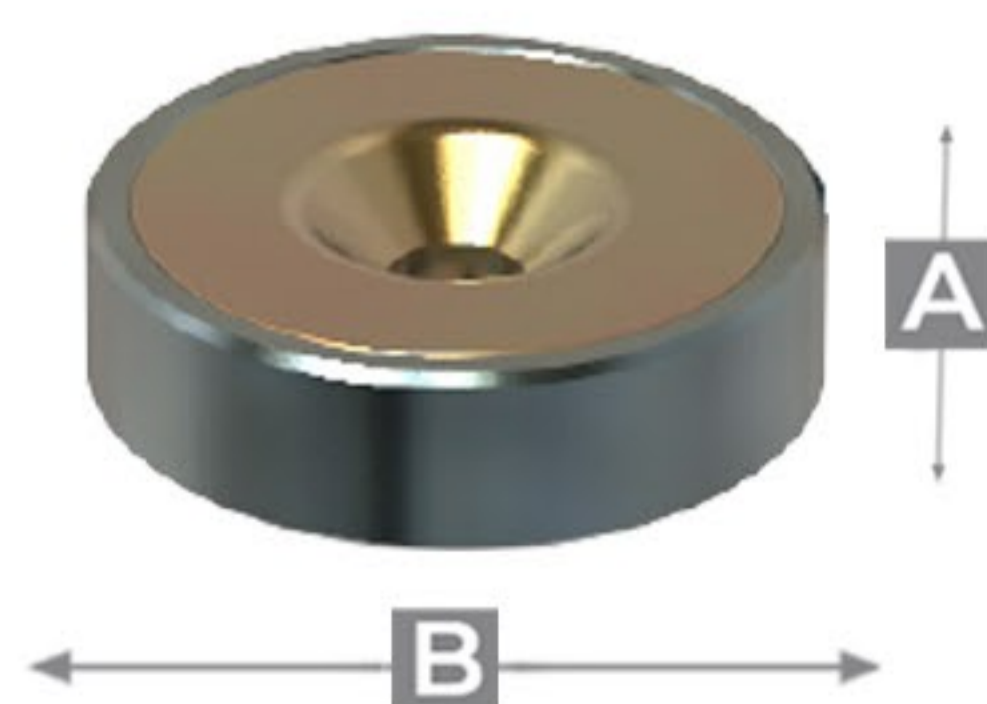





REF. 73116

DIN

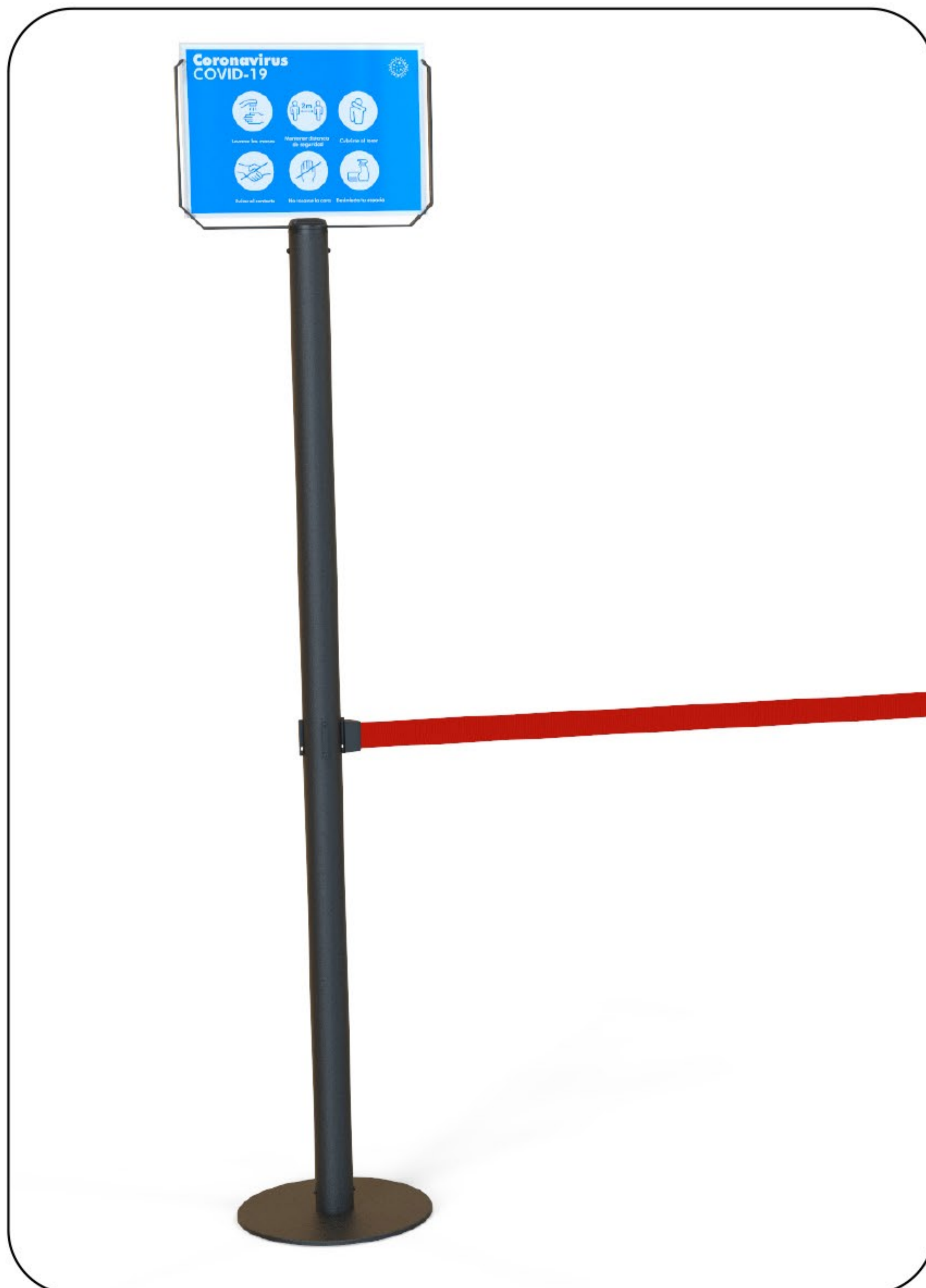
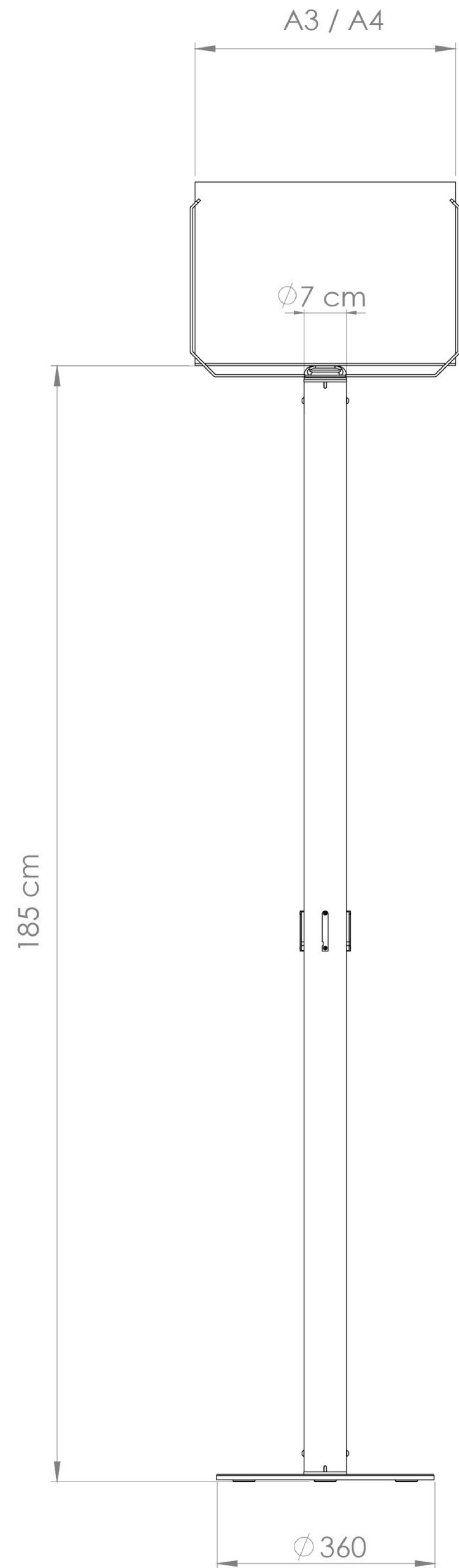
- A4V
- A4H
- A3V
- A3H



DIN	 Kg	 €
73116 A4V	10 Kg	297,80 €
73116 A4H	10 Kg	297,80 €
73116 A3V	10 Kg	314,00 €
73116 A3H	10 Kg	314,00 €

DIN

- A4V
- A4H
- A3V
- A3H



73111

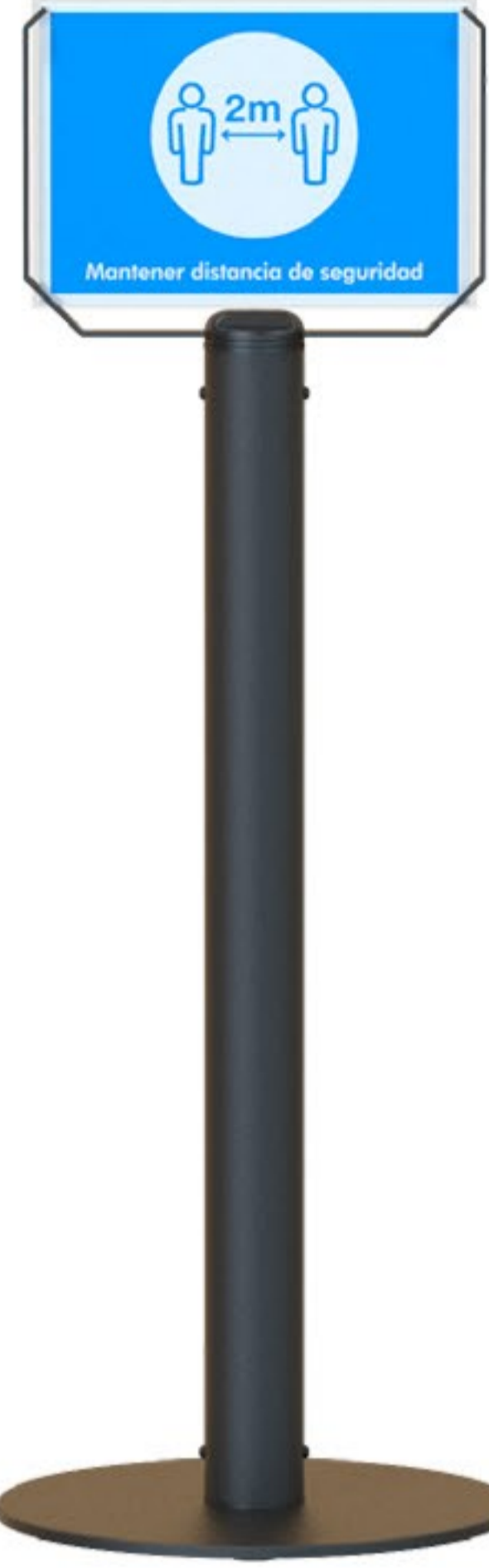

73112



73114



73115



73111 A4V - A4H

- A** 36 cm ↑
- B** 35 x 35 cm
- kg** 8 kg
- €** 151,10 €

73111 A3V - A3H

- A** 36 cm ↑
- B** 35 x 35 cm
- kg** 8 kg
- €** 164,10 €

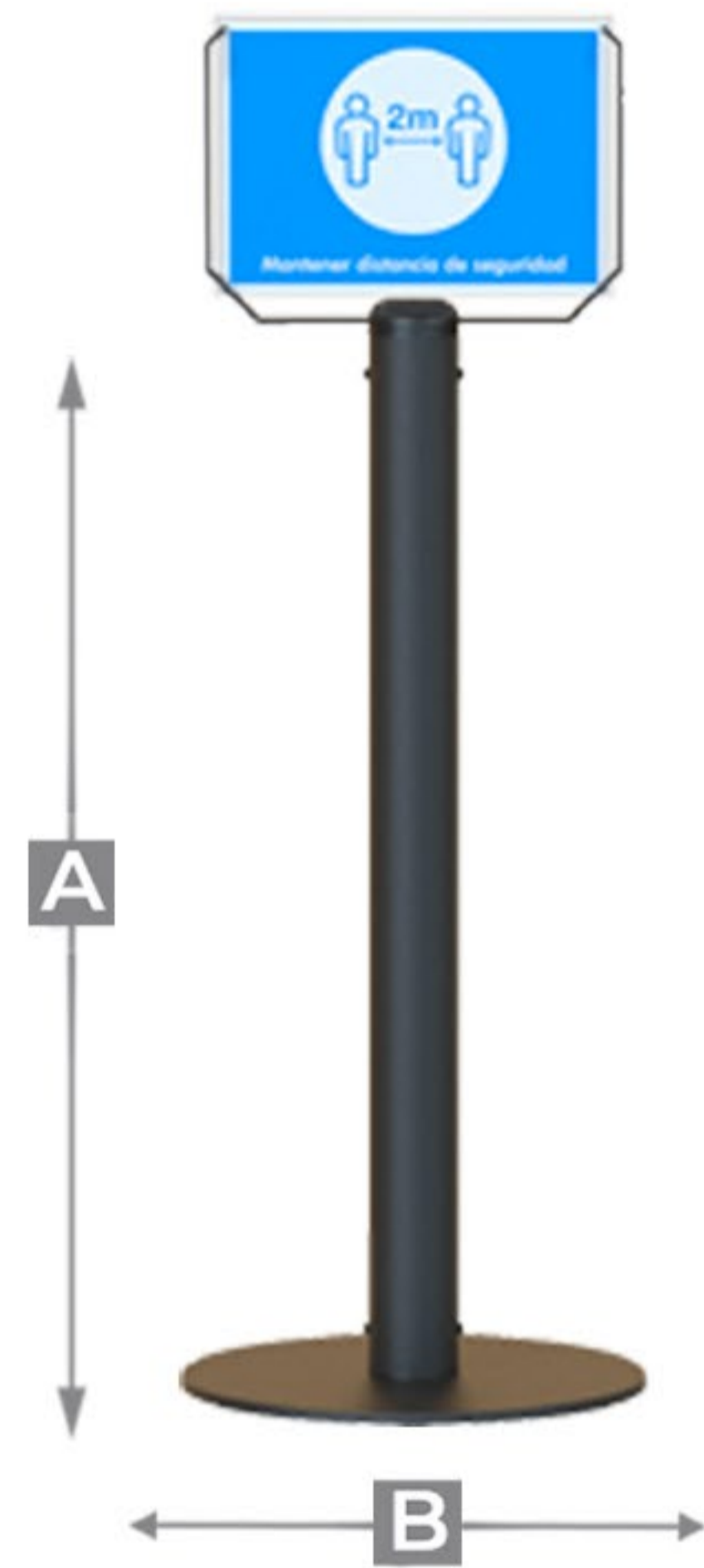

73112 A4V - A4H

- A** 83 cm ↑
- B** 35 x 35 cm
- kg** 8,80 kg
- €** 151,10 €

73112 A3V - A3H

- A** 83 cm ↑
- B** 35 x 35 cm
- kg** 8,80 kg
- €** 164,10 €

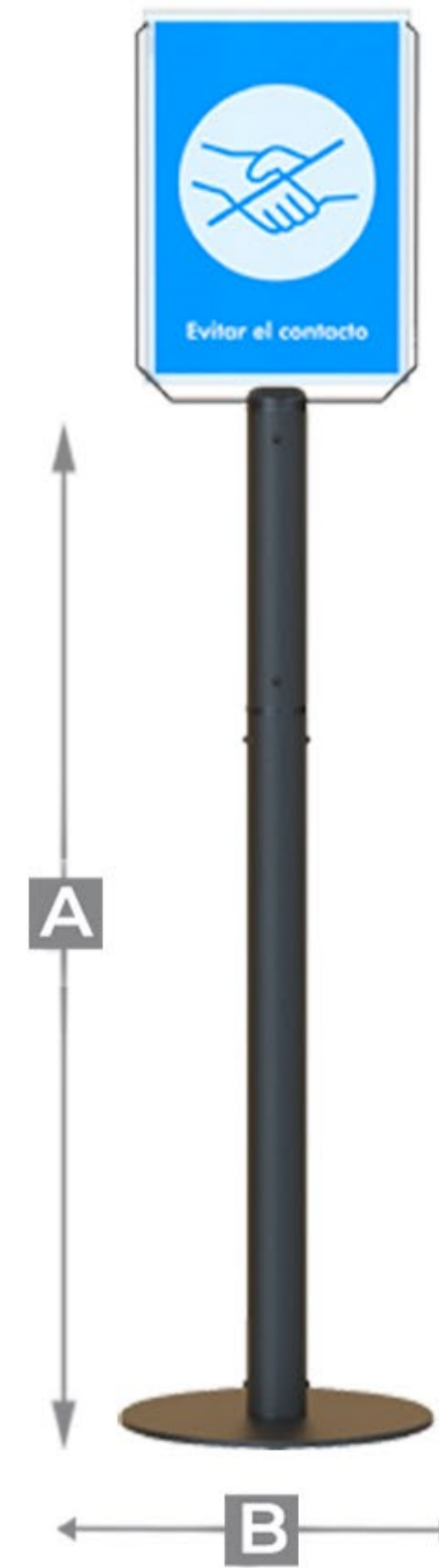

73114 A4V - A4H

- A** 117 cm ↑
- B** 35 x 35 cm
- kg** 9,5 kg
- €** 184,00 €

73114 A3V - A3H

- A** 117 cm ↑
- B** 35 x 35 cm
- kg** 9,5 kg
- €** 198,00 €

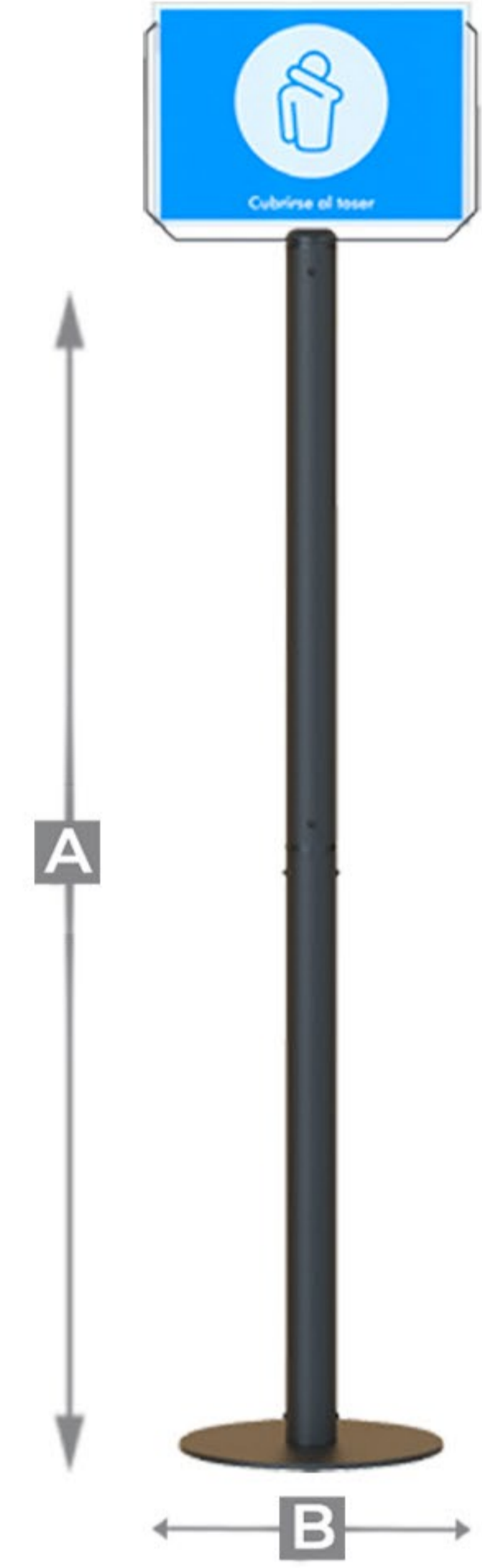

73115 A4V - A4H

- A** 164 cm ↑
- B** 35 x 35 cm
- kg** 10,50 kg
- €** 185,00 €

73115 A4V - A4H

- A** 164 cm ↑
- B** 35 x 35 cm
- kg** 10,50 kg
- €** 199,50 €

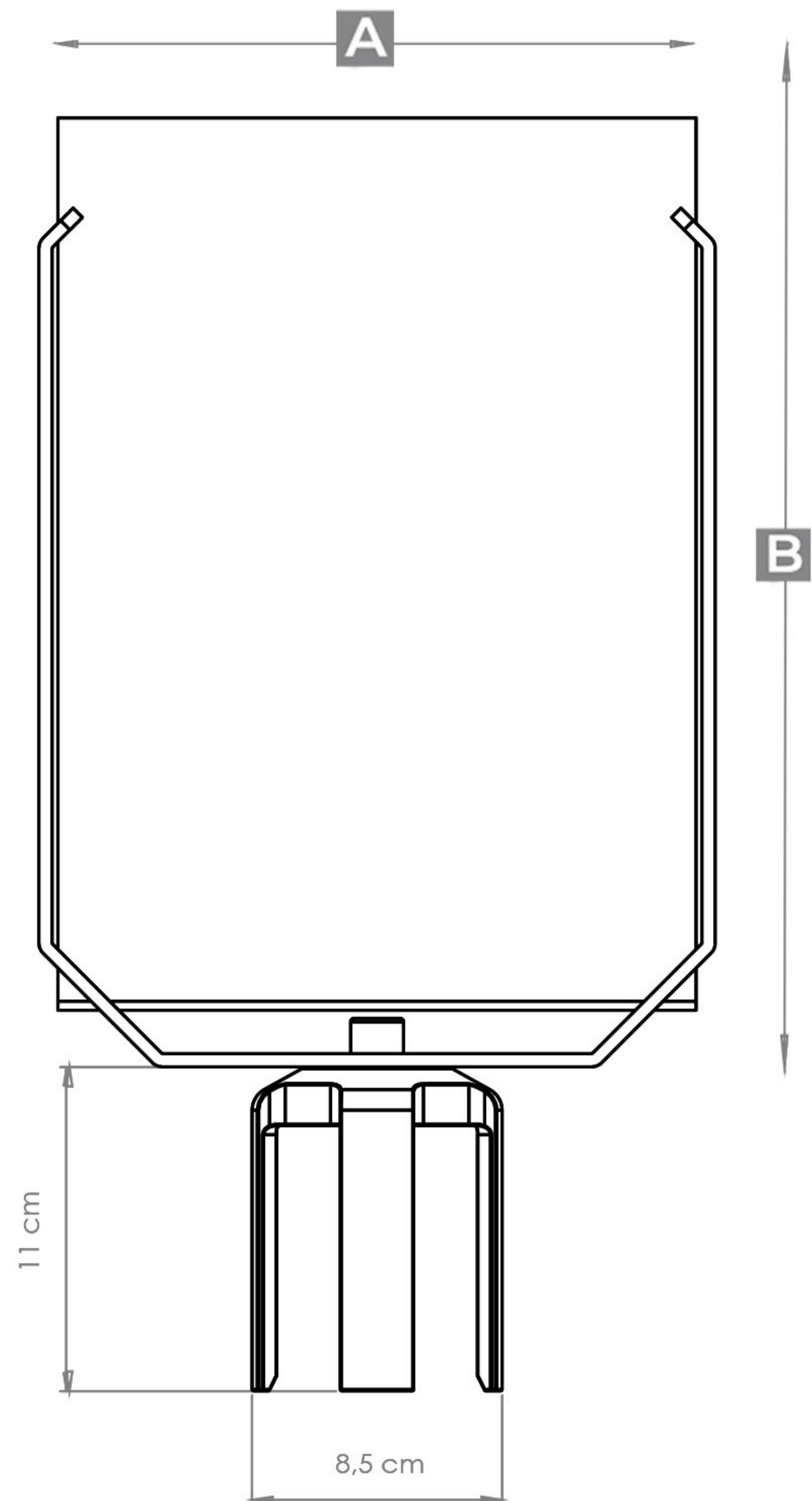

	A	B	Kg	€
REF.PC A4V	40 cm	22 cm	0.50 Kg	74,27 €
REF.PC A4H	35 cm	31 cm	0.50 Kg	74,27 €
REF.PC A3V	50 cm	31 cm	1.00 Kg	94,70 €
REF.PC A3H	48 cm	43 cm	1.00 Kg	94,70 €



REF. 01

DIN | A4V / A4H / A3V / A3H
 Lavarse las manos
 To wash one's hands
 Se laver les mains
 Hände waschen

A4V - A4H **14,10€**
 A3V - A3H **26,70€**



REF. 02

DIN | A4V / A4H / A3V / A3H
 Mantener distancia de seguridad
 Maintain safe distance
 Gardez une distance de sécurité
 Sicherheitsabstand einhalten

A4V - A4H **14,10€**
 A3V - A3H **26,70€**



REF. 03

DIN | A4V / A4H / A3V / A3H
 Cubrirse al toser
 Cover yourself when coughing
 Couvrez-vous en toussant
 Abdeckung beim Husten

A4V - A4H **14,10€**
 A3V - A3H **26,70€**



REF. 04

DIN | A4V / A4H / A3V / A3H
 Evitar el contacto
 Avoid contact
 Évitez tout contact
 Kontakt vermeiden

A4V - A4H **14,10€**
 A3V - A3H **26,70€**

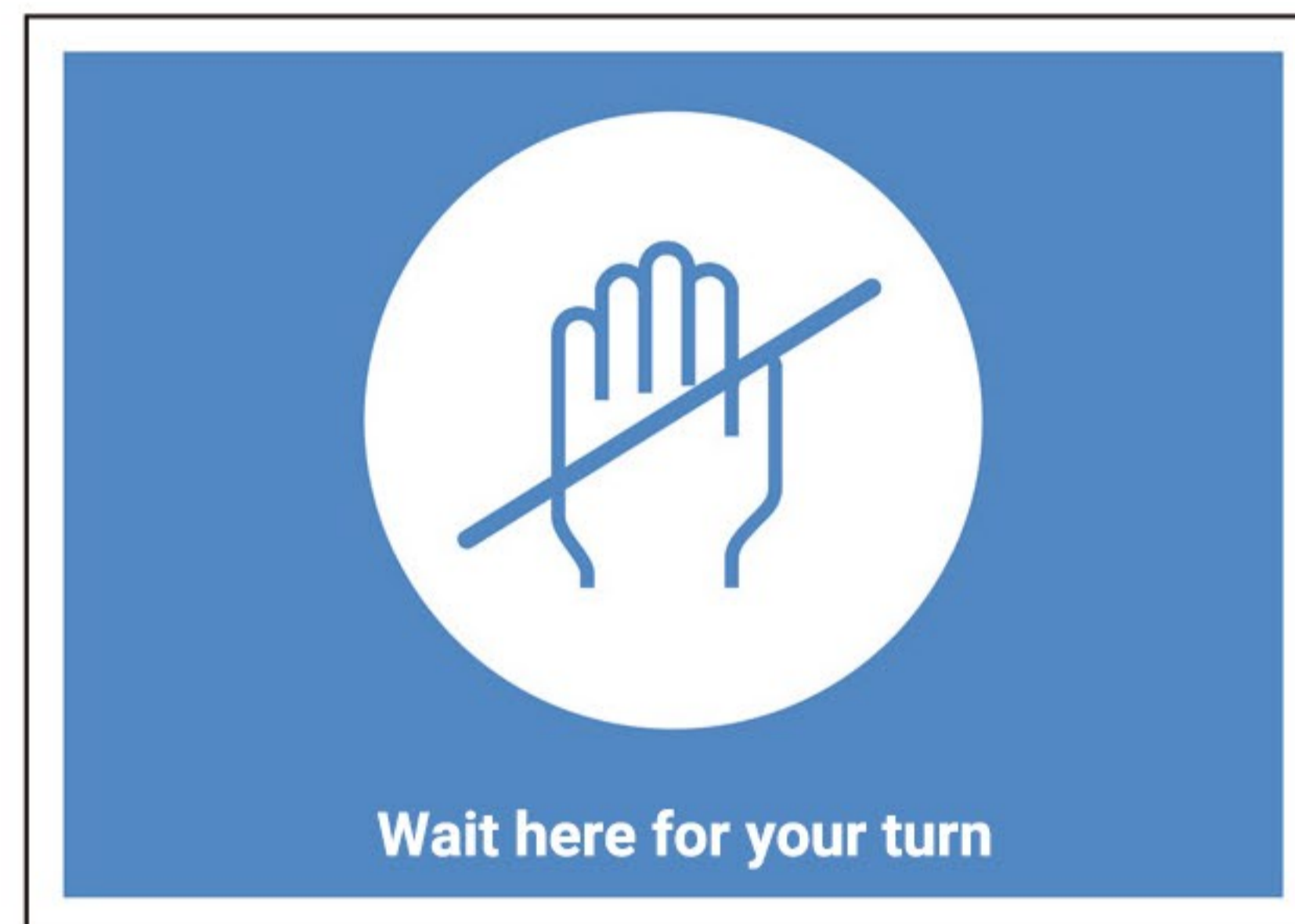

REF. 05

DIN | A4V / A4H / A3V / A3H
 Espere aquí su turno
 Wait here for your turn
 Attendez ici votre tour
 Warten Sie hier, bis Sie an der Reihe sind

A4V - A4H **14,10€**
 A3V - A3H **26,70€**



REF. 06

DIN | A4V / A4H / A3V / A3H
 Desinfecta tu espacio
 Désinfectez votre espace
 Disinfect your space
 Desinfizieren Sie Ihren Raum

A4V - A4H **14,10€**
 A3V - A3H **26,70€**



REF. 07

DIN | A4V / A4H / A3V / A3H
 Desinfecta tu espacio
 Lavarse las manos
 Cubrirse al toser
 Evitar el contacto

A4V - A4H **14,10€**
 A3V - A3H **26,70€**

REF. 73118

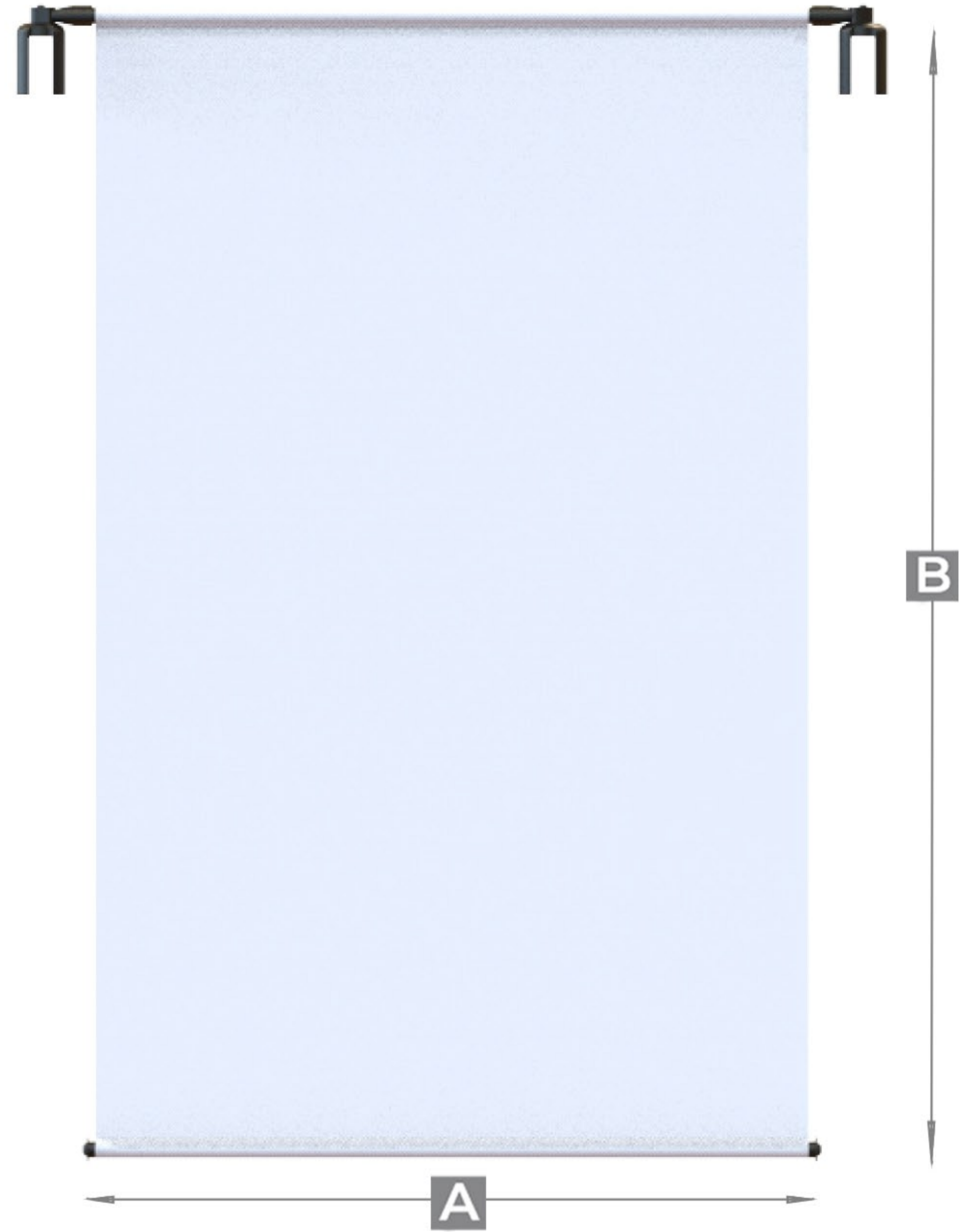

REF. 73117

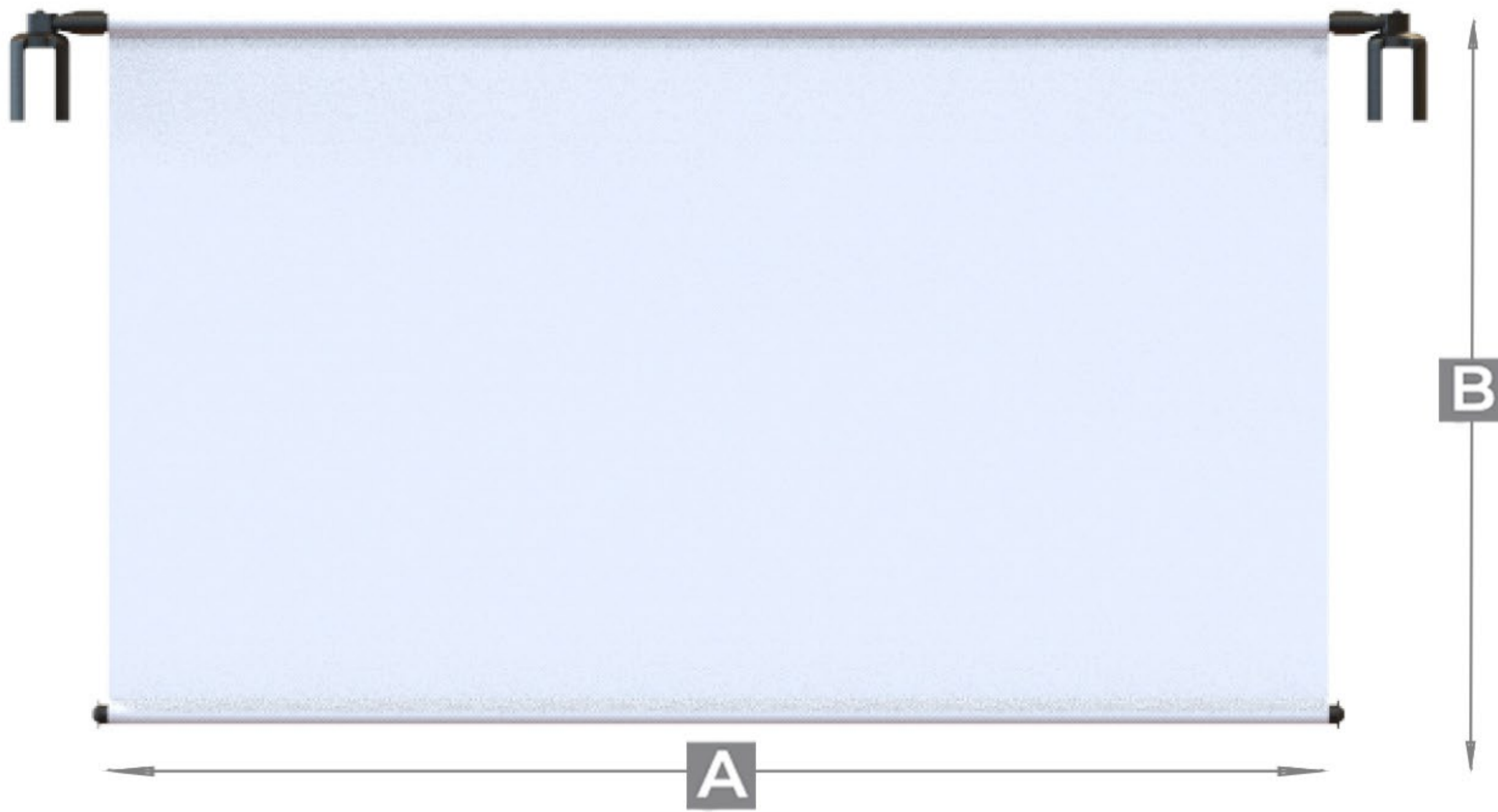

REF. 73117

A	150cm
B	85 cm
Kg	6 kg
€	234,64€
P*	293,91€

REF. 73118

A	110cm
B	170 cm
Kg	5 kg
€	272€
P*	358,60€

COLORES / COLOURS / COULEURS / FARBEN



COLORES / COLOURS / COULEURS / FARBEN

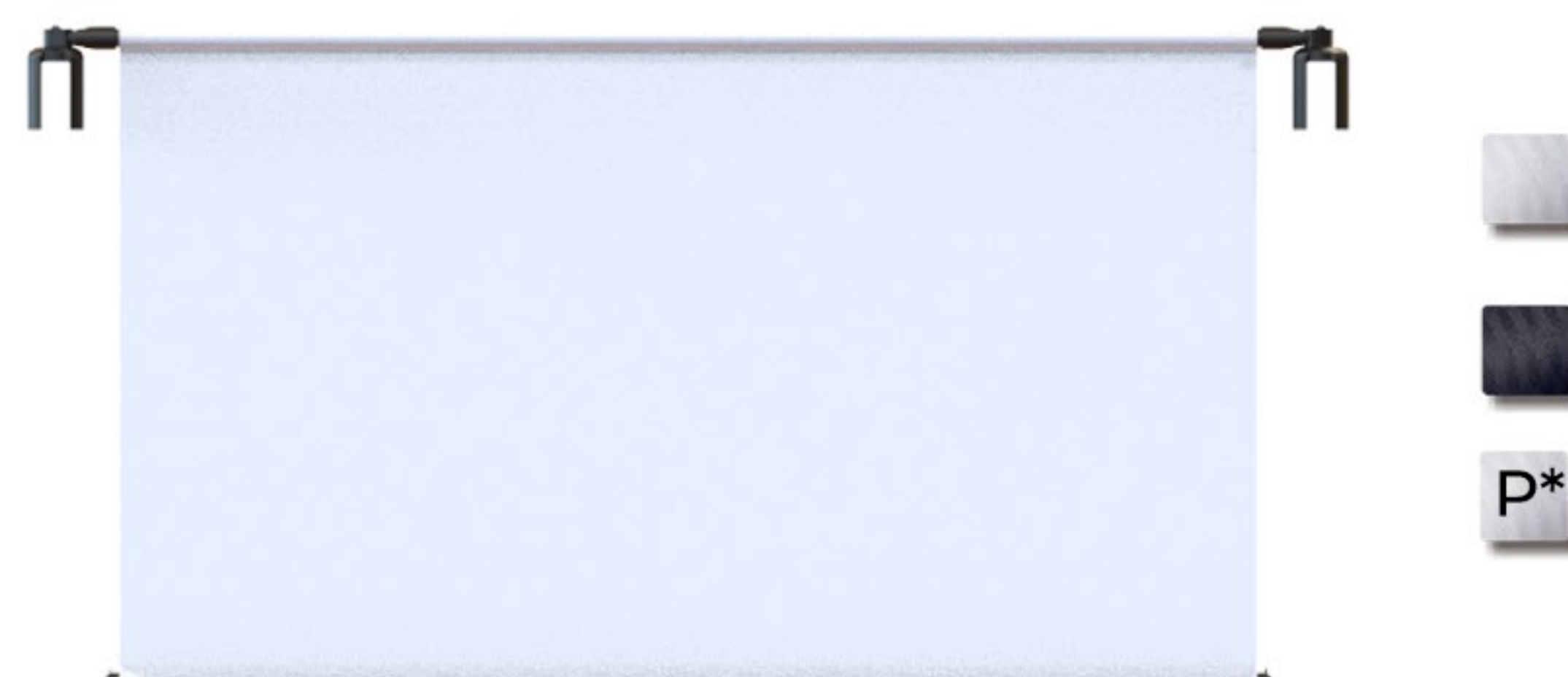

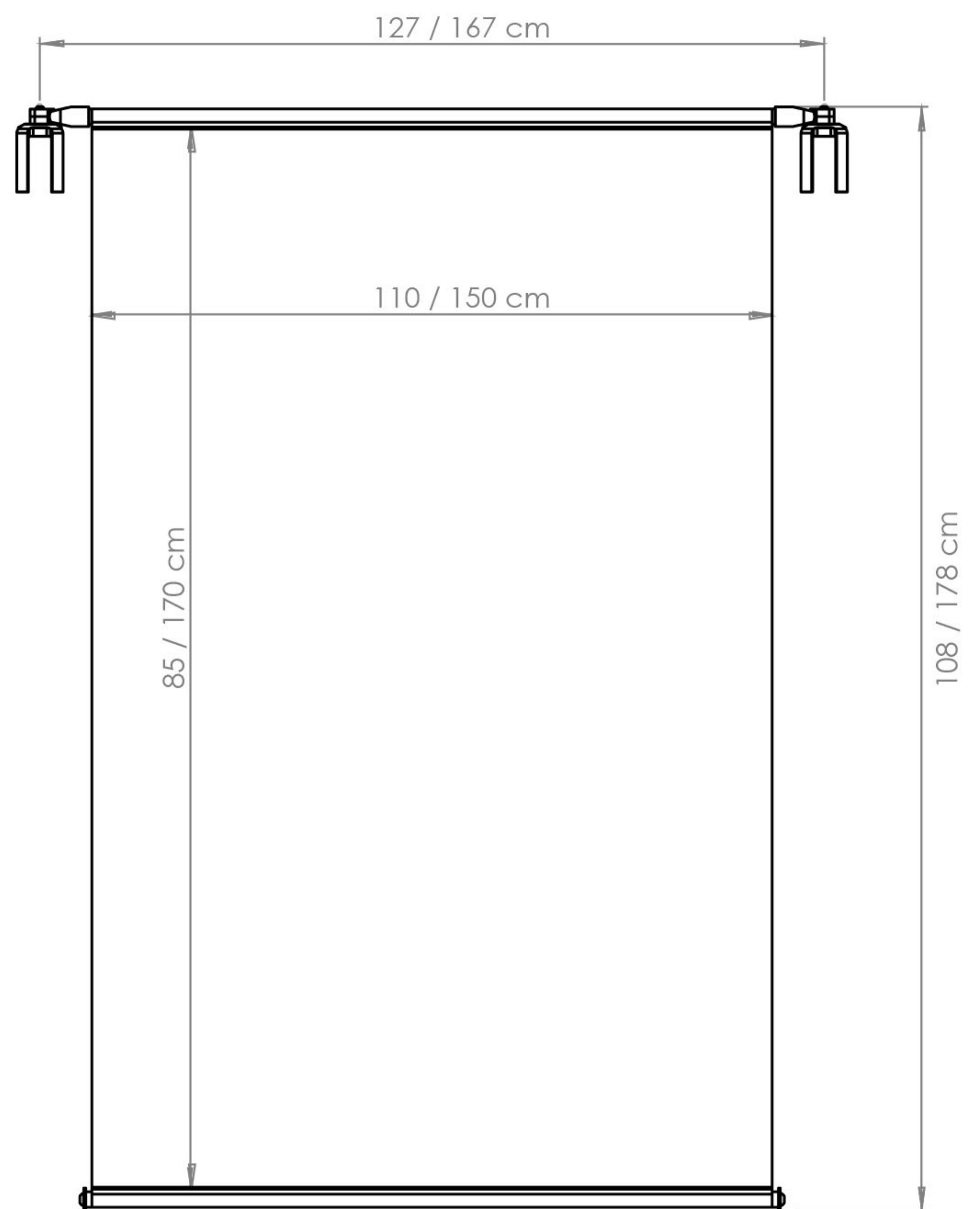
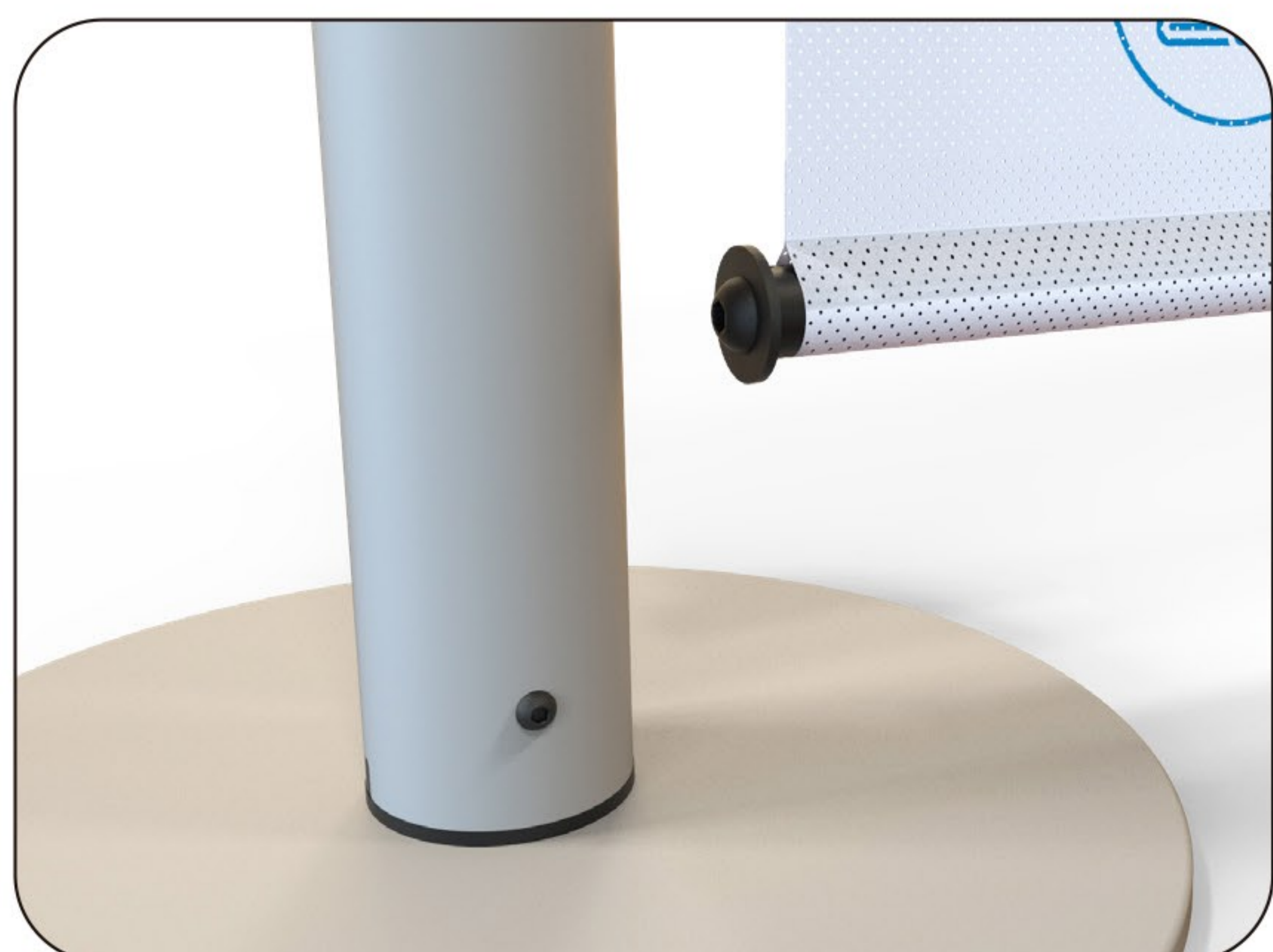



Ref. C100

 CONO REFLECTANTE CON BASE DE GOMA

Artículo de gran utilidad para la delimitación y guiado de espacios.

 CONES RÉFLÉCHISSANTS AVEC BASE EN CAOUTCHOUC

Article de grande utilité pour la délimitation et le guidage d'espaces.

 REFLECTIVE CONES WITH RUBBER BASE

This article is extremely useful for dividing up and limiting access to areas.

 REFLEKTIERENDE KEGEL MIT GUMMIBASIS

Nützlicher Artikel um Bereiche einzugrenzen oder zur Wegmarkierung.



Ref. CN3



Ref. CN3



	A	B	C	D		
Ref.: C100	100 cm	49 cm	49 cm		5,20 Kg	17,40 €
Ref.: CN3	114 cm	49 cm	49 cm	3 m	5,20 Kg	47,37 €
Ref.: CN9	114 cm	49 cm	49 cm	9 m	5,20 Kg	99,97 €



Ref. AD5
 ø 45 cm
 € 9,00 €



Ref. AD6
 ø 45 cm
 € 9,00 €



Ref. AD7
 25 x 15 cm
 € 3,72 €

Ref. AD8
 50 x 15 cm
 € 4,36 €



COLORES / COLOURS / COULEURS / FARBEN





Ref. AD09

COLORES / COLOURS / COULEURS / FARBEN



Ref. AD09

7 x 23 cm

€ 3,72 € (2u)

PERSONALIZADO / PERSONALIZED / PERSONNALISÉ / BENUTZERDEFINERTE

Consultar / Consult / Consulter / Konsultieren



 **PAPELERAS Y CONTENEDORES**

Papelera con pedal de acero inoxidable, depósito interior de plástico con asa, reborde de plástico en la base anticorrosión, disponible en 5, 12, 20, 30 y 40 litros.

 **BINS AND CONTAINERS**

Bin with pedal made of stainless steel, interior deposit made of plastic with a handle, ledge of plastic with a anti-rust base, available in 5, 12, 20, 30 and 40 litres.

 **POUBELLES ET CONTENEURS**

Poubelle à pédale en acier inoxydable, récipient intérieur en plastique avec poignée, cercle protecteur en plastique anticorrosion, disponible en 5, 12, 20, 30 et 40 litres.

 **ABFALLEIMER UND BEHÄLTER**

Rostfreier Stahlabfalleimer mit Pedal, Kunststoffbehälter mit Griff, Kunststofffassung mit rostresistenter Grundfläche, lieferbar in 5, 12, 20, 30 und 40 Liter.

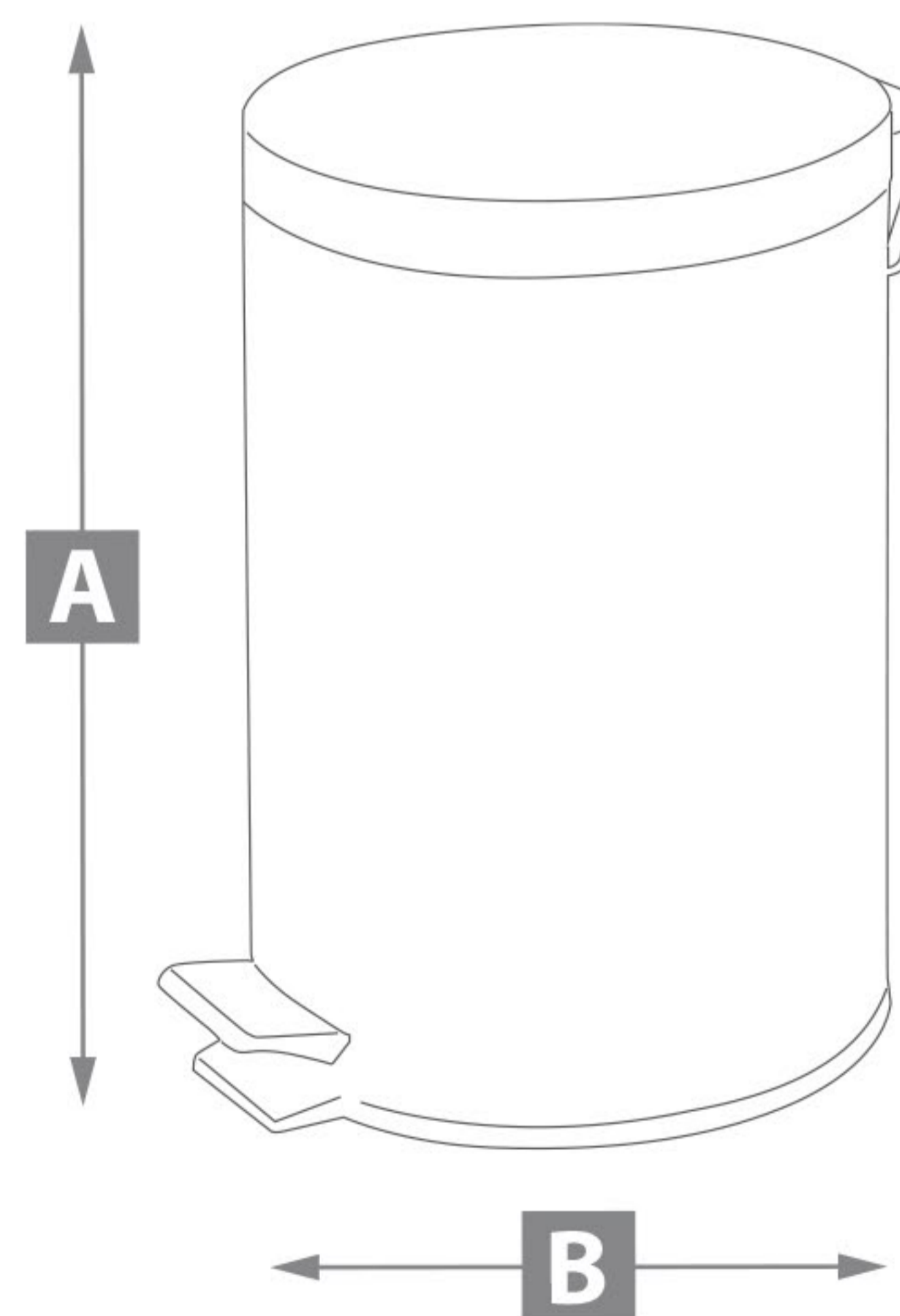

	A	B			
Ref.: 460038	26,5 cm	19,5 cm	1.30 Kg	14,65 €	5L
Ref.: 460040	38 cm	24,5 cm	1.75 Kg	26,02 €	12L
Ref.: 460041	44,5 cm	29,2 cm	2.90 Kg	37,99 €	20L
Ref.: 460042	64 cm	29,2 cm	5.31 Kg	58,90 €	30L
Ref.: 460043	66 cm	35 cm	8.37 Kg	78,70 €	40L

 PAPELERAS Y CONTENEDORES

Papelera con pedal de acero inoxidable, deposito interior de plástico con asa, reborde de plástico en la base anticorrosión, disponible en 5, 12, 20, 30 y 40 litros.

 BINS AND CONTAINERS

Bin with pedal made of stainless steel, interior deposit made of plastic with a handle, ledge of plastic with a anti-rust base, available in 5, 12, 20. 30 and 40 litres.





 AVEC POIGNÉE CERCLE

Poubelle à pédale en acier inoxydable , récipient intérieur en plastique avec poignée,cercle protecteur en plastique anticorrosion, disponible en 5, 12, 20, 30 et 40 litres.

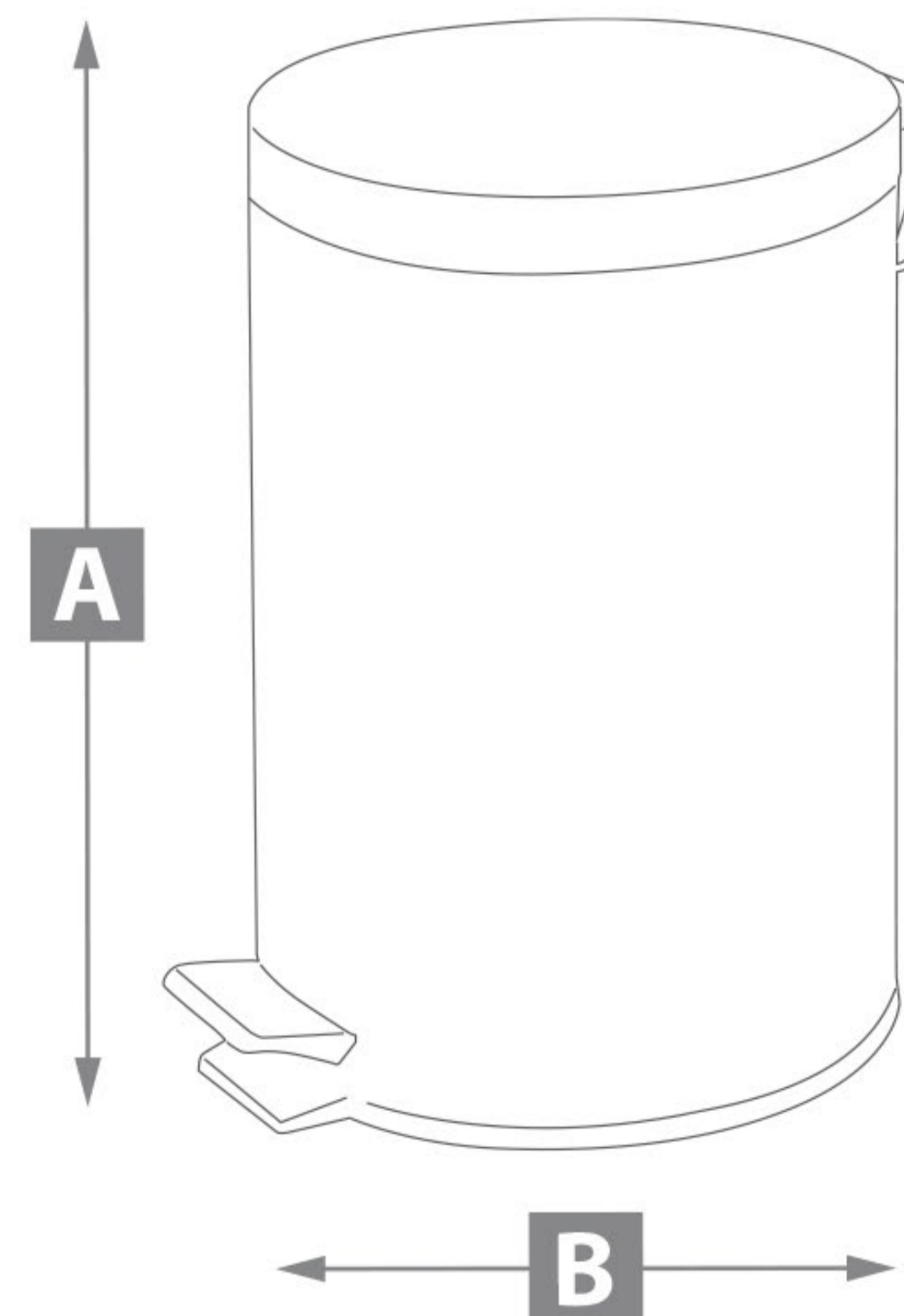
 ABFALLEIMER UND BEHÄLTER

Rostfreier Stahlabfalleimer mit Pedal, Kunststoffbehälter mit Griff, Kunststofffassung mit rostresistenter Grundfläche, lieferbar in 5, 12, 20, 30 und 40 Liter.



	A	B				
Ref.: 460038_	26,5 cm	19,5 cm	1.30 Kg	15,65 €		5L
Ref.: 460040_	38 cm	24,5 cm	1.75 Kg	27,02 €		12L
Ref.: 460041_	44,5 cm	29,2 cm	2.90 Kg	38,99 €		20L
Ref.: 460042_	64 cm	29,2 cm	5.31 Kg	59,90 €		30L
Ref.: 460043_	66 cm	35 cm	8.37 Kg	79,70 €		40L



 PAPELERAS Y CONTENEDORES

Carrito móvil de estructura metálica. Dispone de ruedas con freno. Papelera con aro protector y tapa superior.

 BINS AND CONTAINERS

Moveable trolley with metal frame, mounted on casters with brakes. Wastepaper basket with protective ring and lid.

 PAVEC POIGNÉE CERCLE

Chariot mobile, structure métallique. Dispose de roulettes avec frein. Corbeille à papier avec cercle protecteur et couvercle supérieur.

 ABFALLEIMER UND BEHÄLTER

Wagen mit Metallrahmen. Enthält Rollen mit Bremsen. Papierkorb mit Gummiunterseite und Deckel.



	A	B	C				
Ref. 43117	38,5 cm	80 cm	27 cm	12.54 Kg	152,00 €	16 L	x 3
Ref. 43118	56,5 cm	80 cm	27 cm	14.34 Kg	180,00 €	25 L	x 3
Ref. 43119	73,5 cm	80 cm	27 cm	16.71 Kg	214,00 €	35 L	x 3

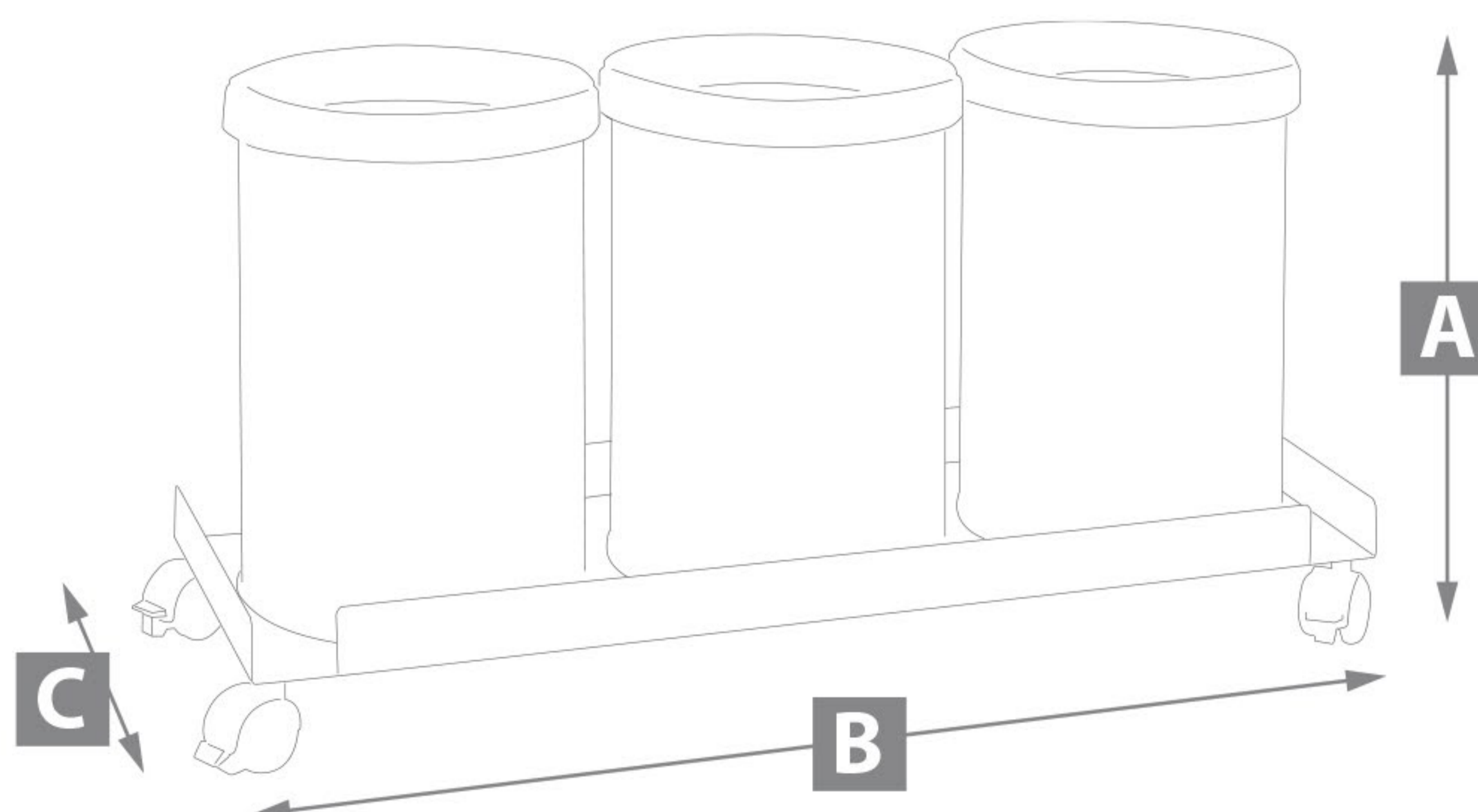



	A	B			
Ref. 4602_	32,5 cm	26 cm	1.98 Kg	29,89 €	16 L
	A	B			
Ref. 4802_	67,5 cm	26 cm	3.37 kg	54,30 €	35 L

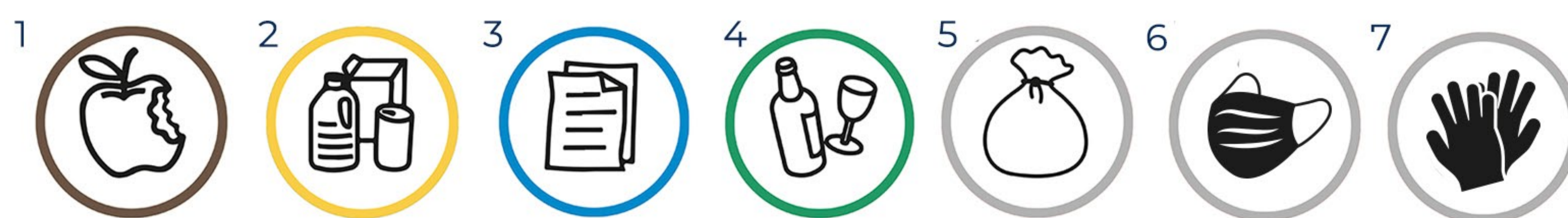
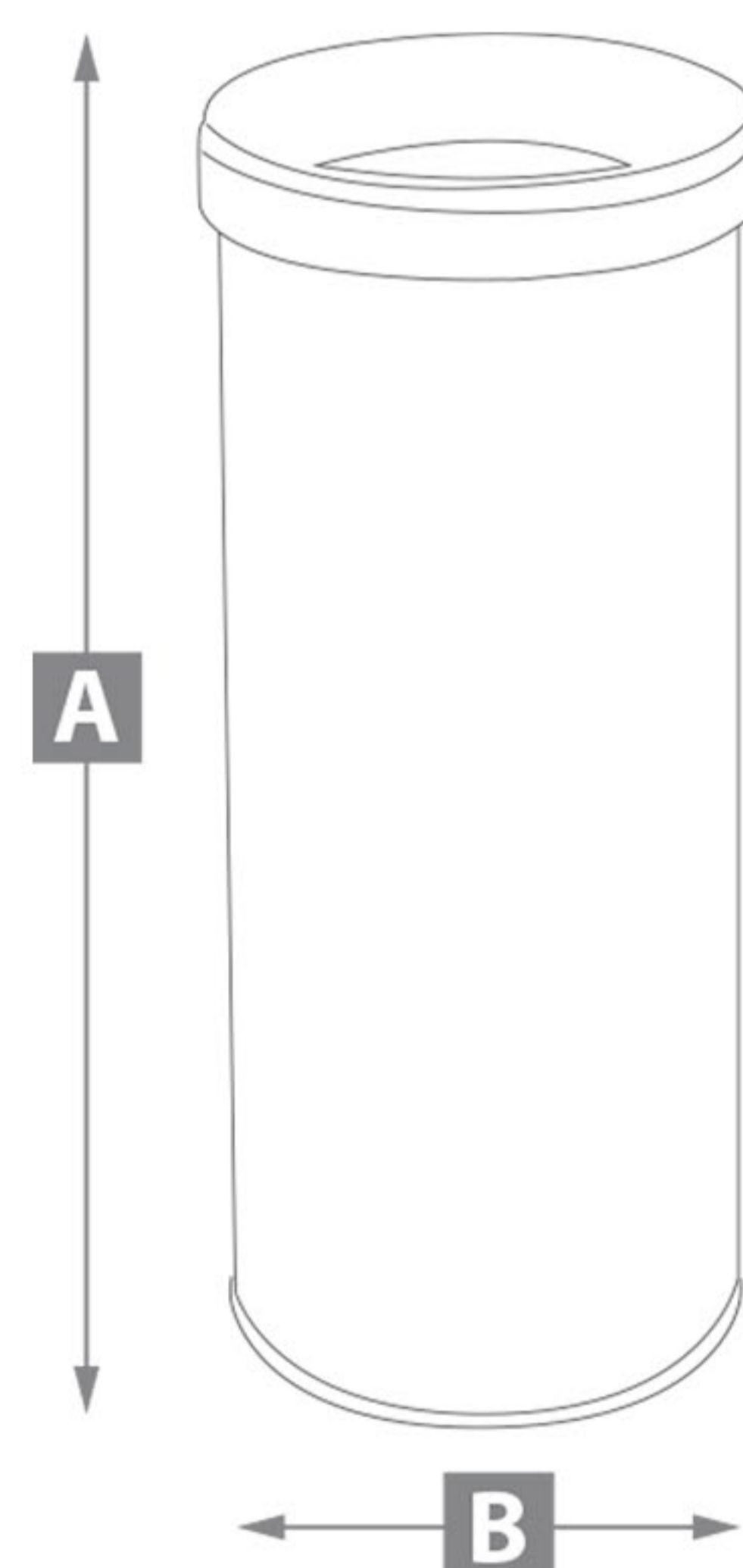



	A	B			
Ref. 4602B_	32,5 cm	26 cm	1.98 Kg	29,89 €	16 L

	A	B			
Ref. 4802B_	67,5 cm	26 cm	3.37 Kg	54,30 €	35 L

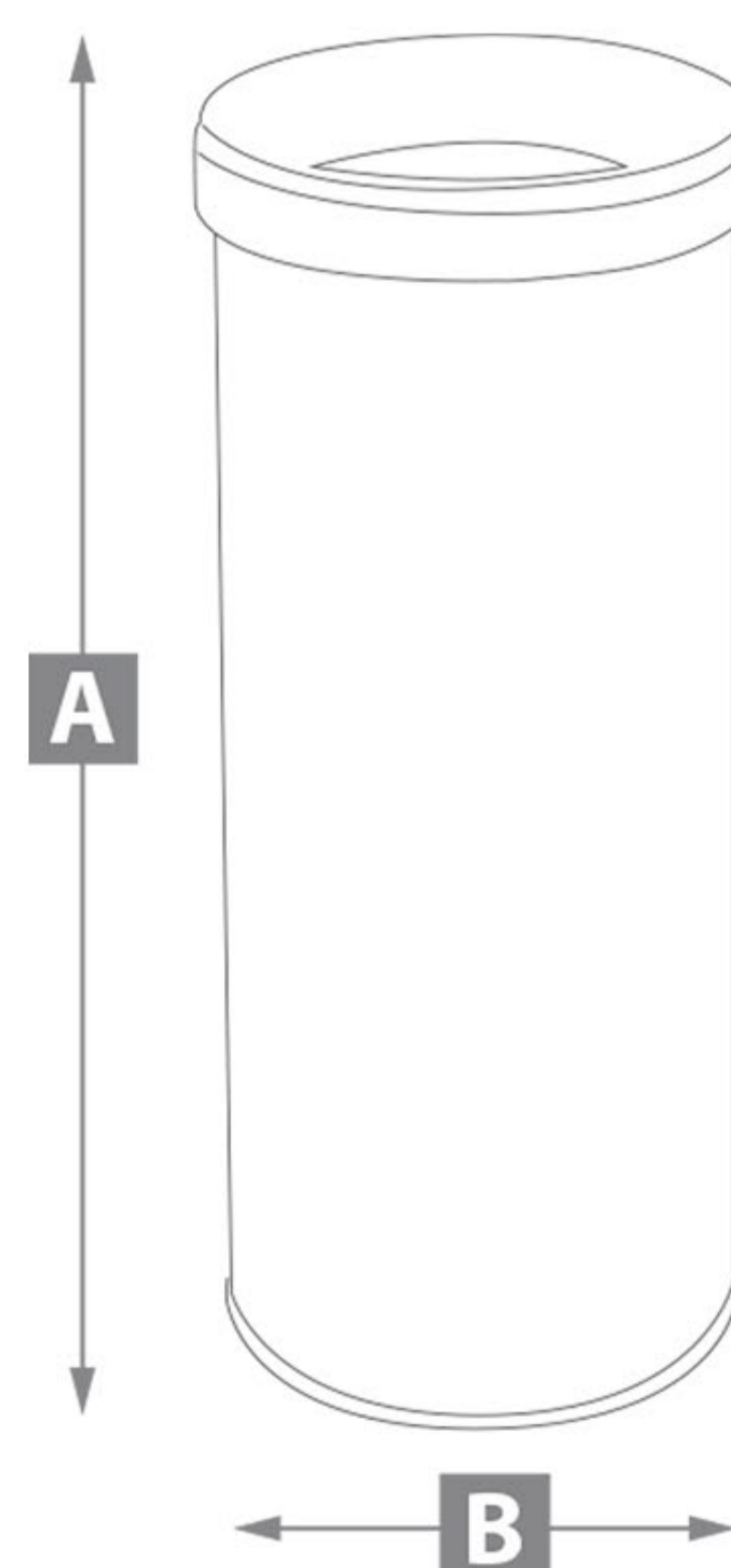

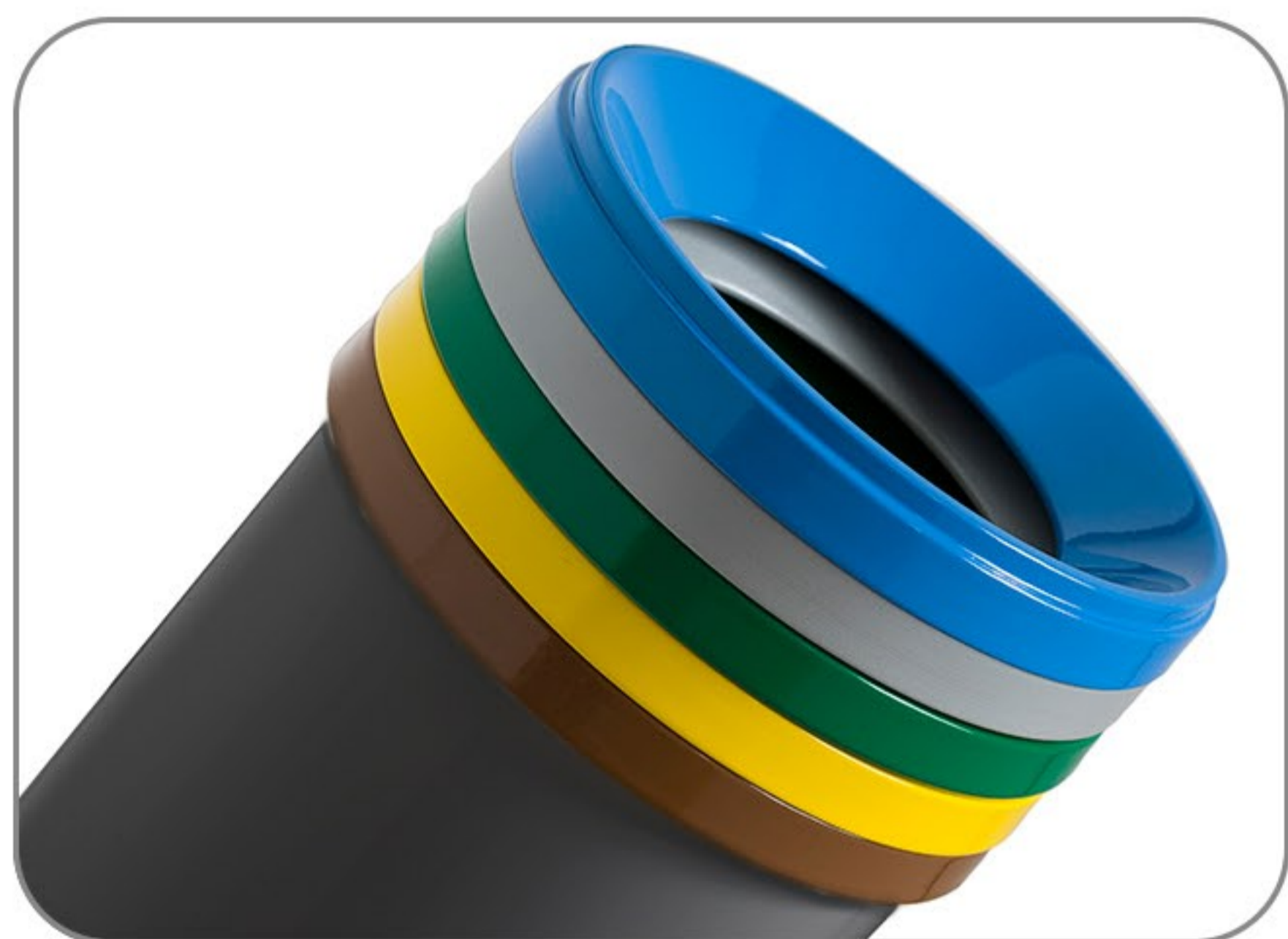

	A	B			
Ref. 4602G_	32,5 cm	26 cm	1.98 Kg	29,89 €	16L

	A	B			
Ref. 4802G_	67,5 cm	26 cm	3.37 Kg	54,30 €	35L

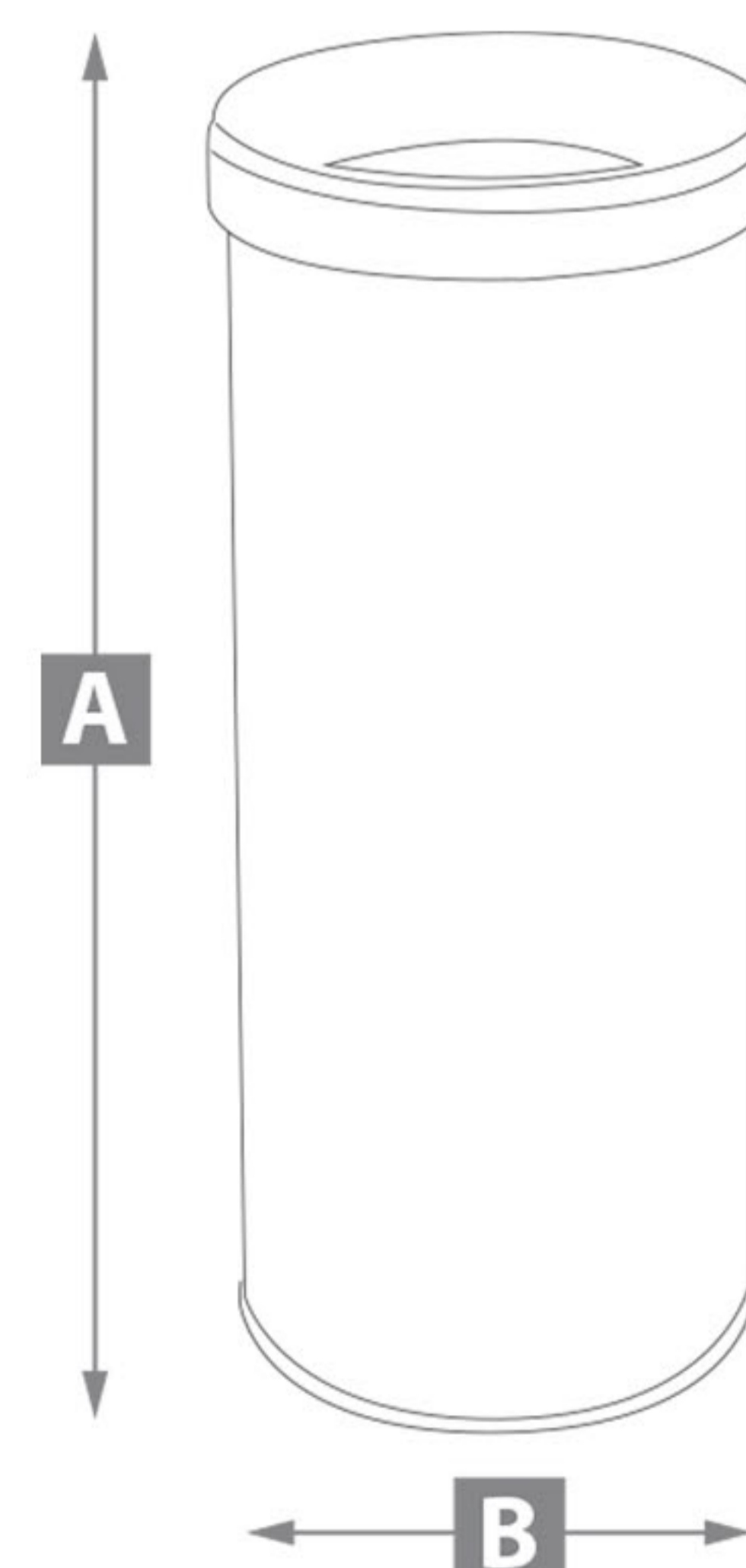



 PAPELERA METÁLICA PARA RECICLAJE

Pintada en color grafito texturado. Tapa disponible en 7 colores.

 PAPIER DE RECYCLAGE

Corbeille à papier de recyclage métallique peint en graphite texturé. Le couvercle est disponible en 7 couleurs.

 RECYCLING BIN

Recycling bin painted in textured graphite colour. Top available in 7 colors.

 RECYCLINGPAPIERKORB

Recyclingpapierkorb in texturierte Graphit. Deckel erhältlich in 7 Farben.

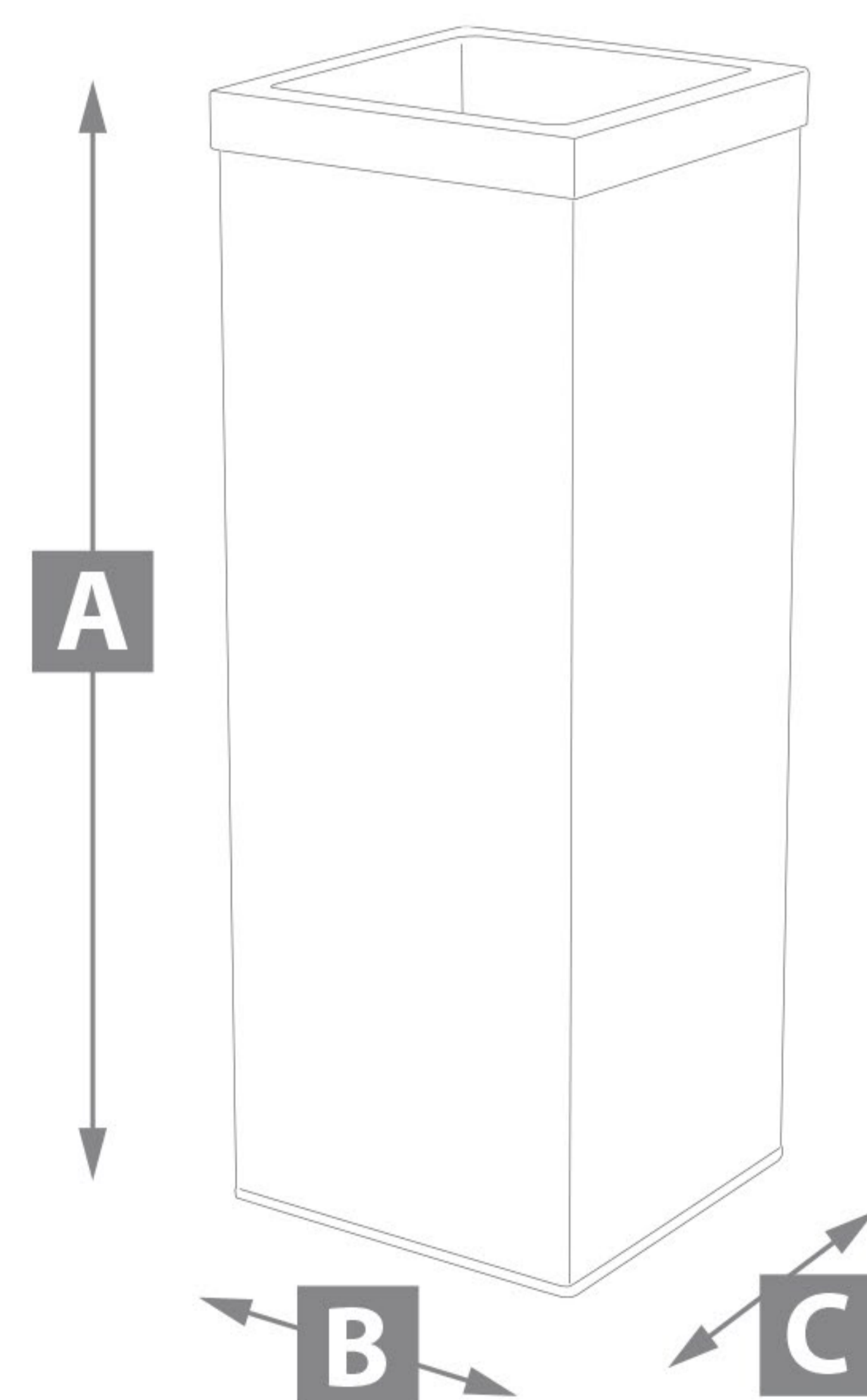

Ref. 5402_ **A** 71 cm **B** 25 cm **C** 25 cm 6,00 Kg **77,89 €** **44 L**



 PAPELERA METÁLICA PARA RECICLAJE

Papelera metálica para reciclaje pintada en color blanco texturado. Tapa disponible en 7 colores.

 PAPIER DE RECYCLAGE

Corbeille à papier de recyclage métallique peint en blanc texturé. Le couvercle est disponible en 7 couleurs.

 RECYCLING BIN

Recycling bin painted in textured white colour. Top available in 7 colors.

 RECYCLINGPAPIERKORB

Recyclingpapierkorb in texturierte weiß. Deckel erhältlich in 7 Farben.

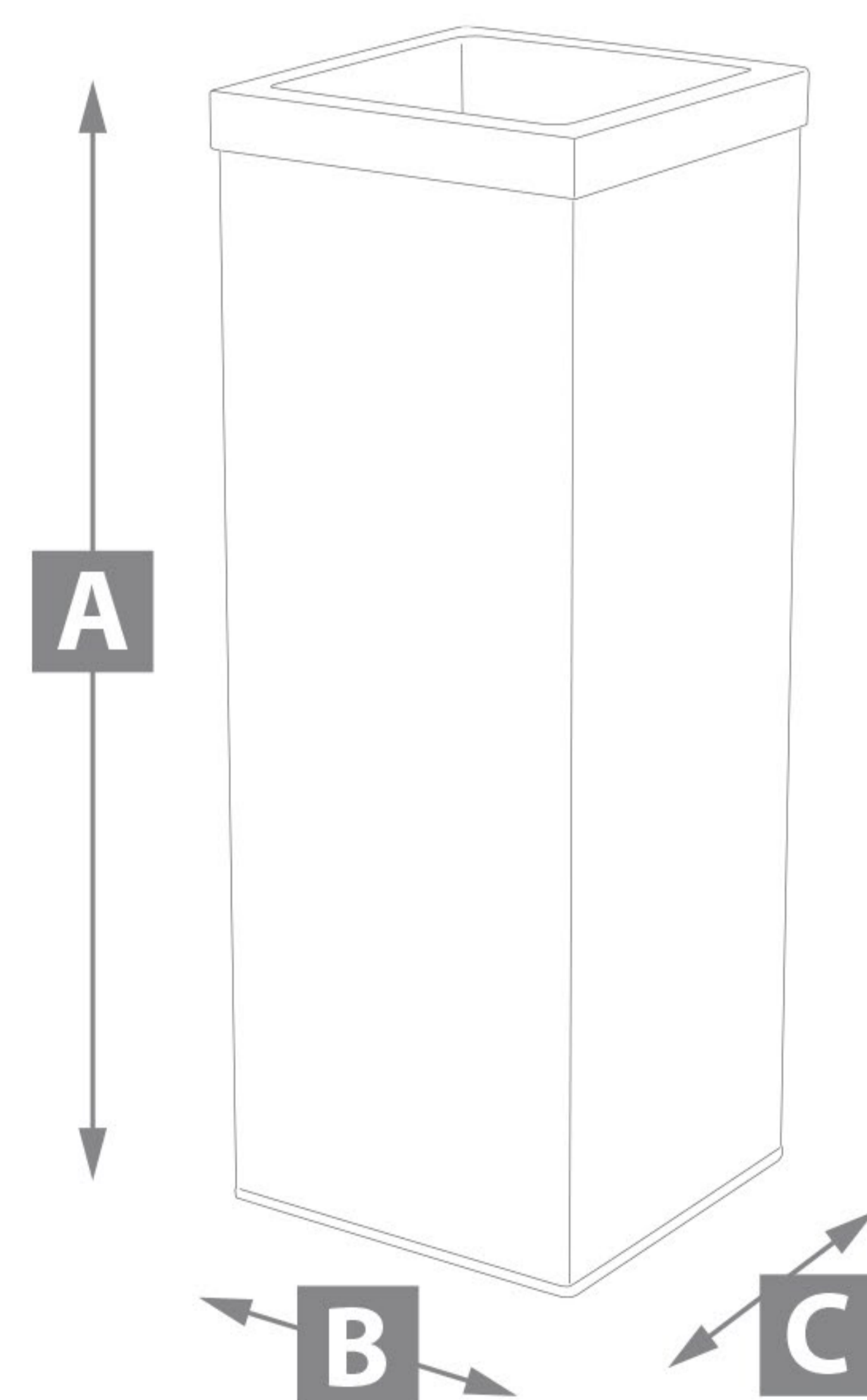
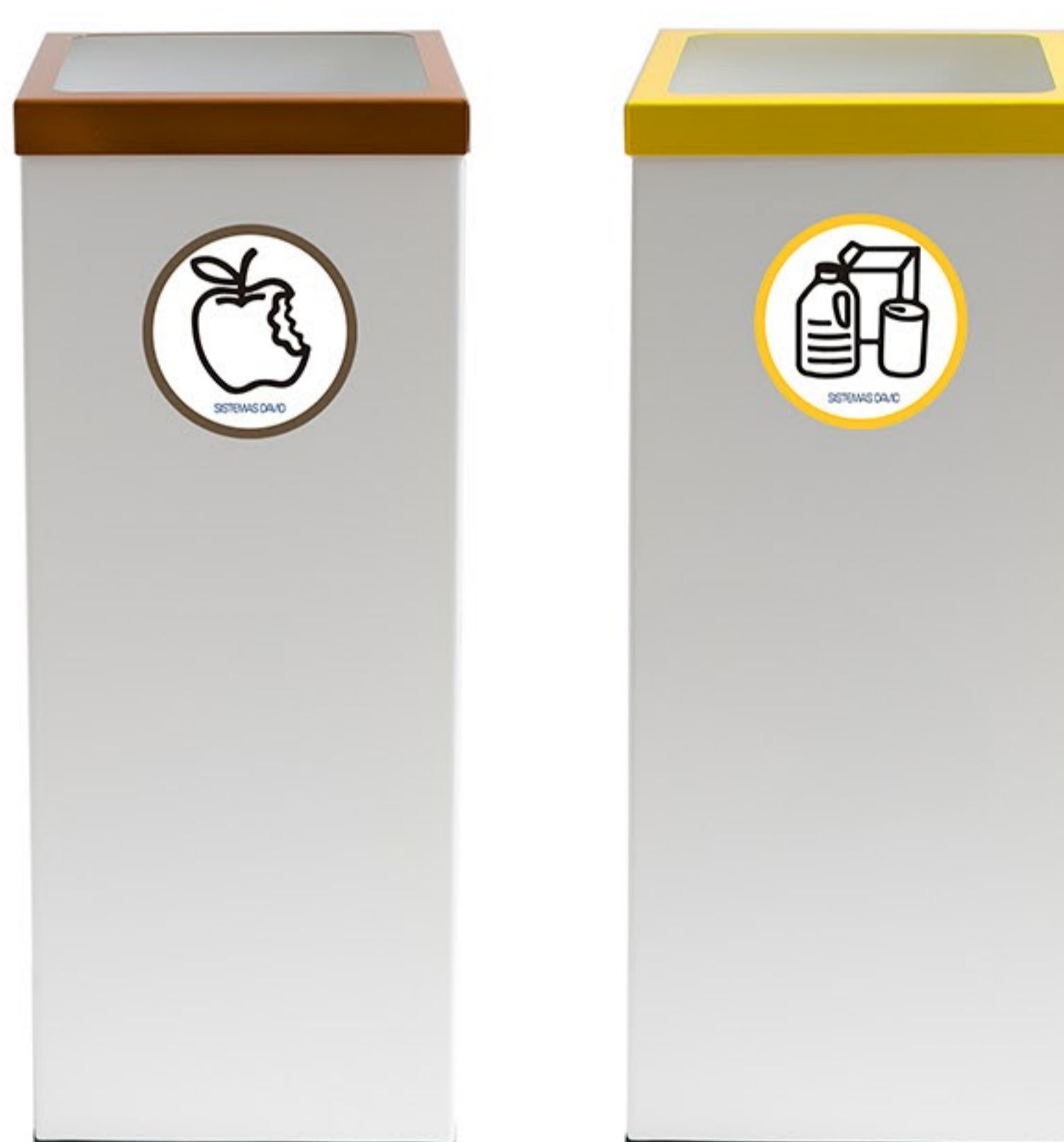

Ref. 5402B_ **A** 71 cm **B** 25 cm **C** 25 cm 6,00 Kg **77,89 €** **44 L**





 PAPELERA PARA RECICLAJE

Papelera metálica para reciclaje pintada en color grafito texturado, tapa superior abatible y aro interior para sujeción de bolsa. Tapa disponible en 7 colores.

 PAPIER DE RECYCLAGE

Corbeille à papier de recyclage métallique peint en graphite texturé, couvercle à charnière et bague intérieure pour fixer le sacs poubelles. Le couvercle est disponible en 7 couleurs.

 RECYCLING BIN

Recycling bin painted in textured graphite colour, lid swing top and inner ring for fastening bag. Top available in 7 colors.

 RECYCLINGPAPIERKORB

Recyclingpapierkorb in texturierte Graphit, Deckel Swing Top und innerer Ring zur Befestigung der Tasche. Deckel erhältlich in 7 Farben.

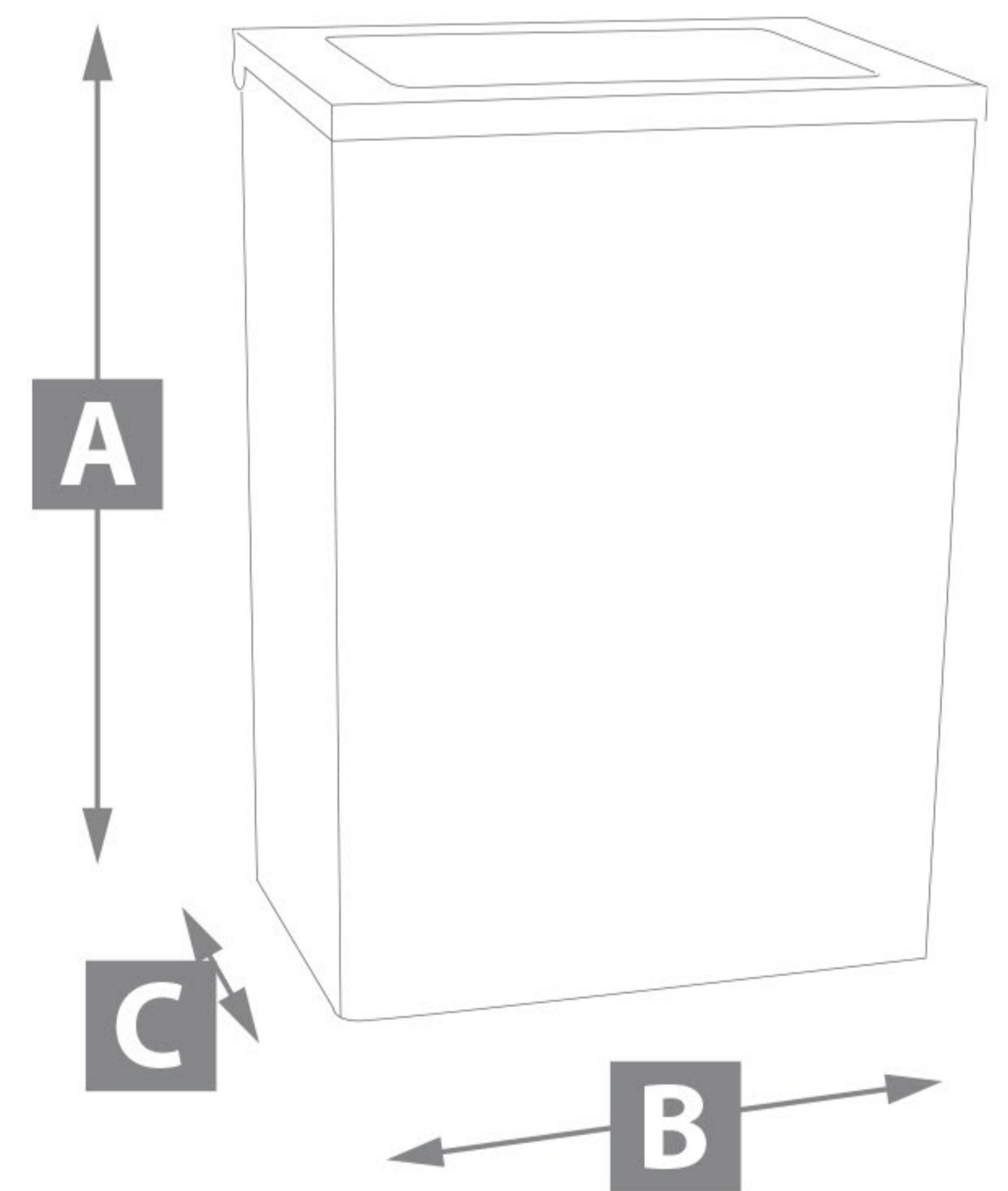

	A	B	C			
Ref. 5202_	80,5 cm	36 cm	26,5 cm	9.43 Kg	159,98 €	76 L
Ref. 5303_	81 cm	39,5 cm	28,5 cm	17.00 Kg	199,98 €	91 L





 **CONTENEDOR INDUSTRIAL METÁLICO CON PEDAL 60 L.**

Contenedor industrial fabricado con chapa de hierro de 1 mm. de espesor.

Tapa superior abatible y aro interior para sujeción de bolsa.

Tapa disponible en 6 colores: Azul, Amarillo, Verde, Marrón, gris y blanco

Medidas: Alto: 68,5 cm. Ancho: 34,5 cm. Fondo: 34,5 cm.

Capacidad 60 Litros.

 **CONTENEUR INDUSTRIEL EN MÉTAL AVEC PÉDALE 60 L.**

Conteneur industriel en tôle de fer 1 mm. d'épaisseur. Couvercle à charnière et bague intérieure pour fixer le sacs poubelles.

Le couvercle est disponible en 6 couleurs : Bleu, jaune, vert, marron, gris et blanc.

Mesures : Hauteur : 68,5 cm. Largeur : 34,5 cm. Profondeur : 34,5 cm.

Capacité 60 litres.

 **INDUSTRIAL METAL CONTAINER WITH PEDAL 60L**

Industrial metal container with a 1mm thick iron plate. Lid swing top and inner ring for fastening bag.

Top available in 6 colors : Blue, Yellow, Green, Brown, Gray and White.

Measurements: Height: 68,5 cm. Width: 34,5 cm. Depth: 34,5 cm.

Capacity 60 Liters.

 **INDUSTRIELLER METALLCONTAINER MIT PEDAL 60L.**

Industrieller Metallcontainer with einer 1mm dicken Eisenplatte. Deckel Swing Top und innerer Ring zur Befestigung der Tasche.

Deckel erhältlich in 7 Farben : Blau, Gelb, Grün, Braun, Grau und Weiß.

Maßnahmen : Höhe: 68,5 cm. Breite: 34,5 cm. Tiefe: 34,5 cm.

Kapazität 60 Liter.

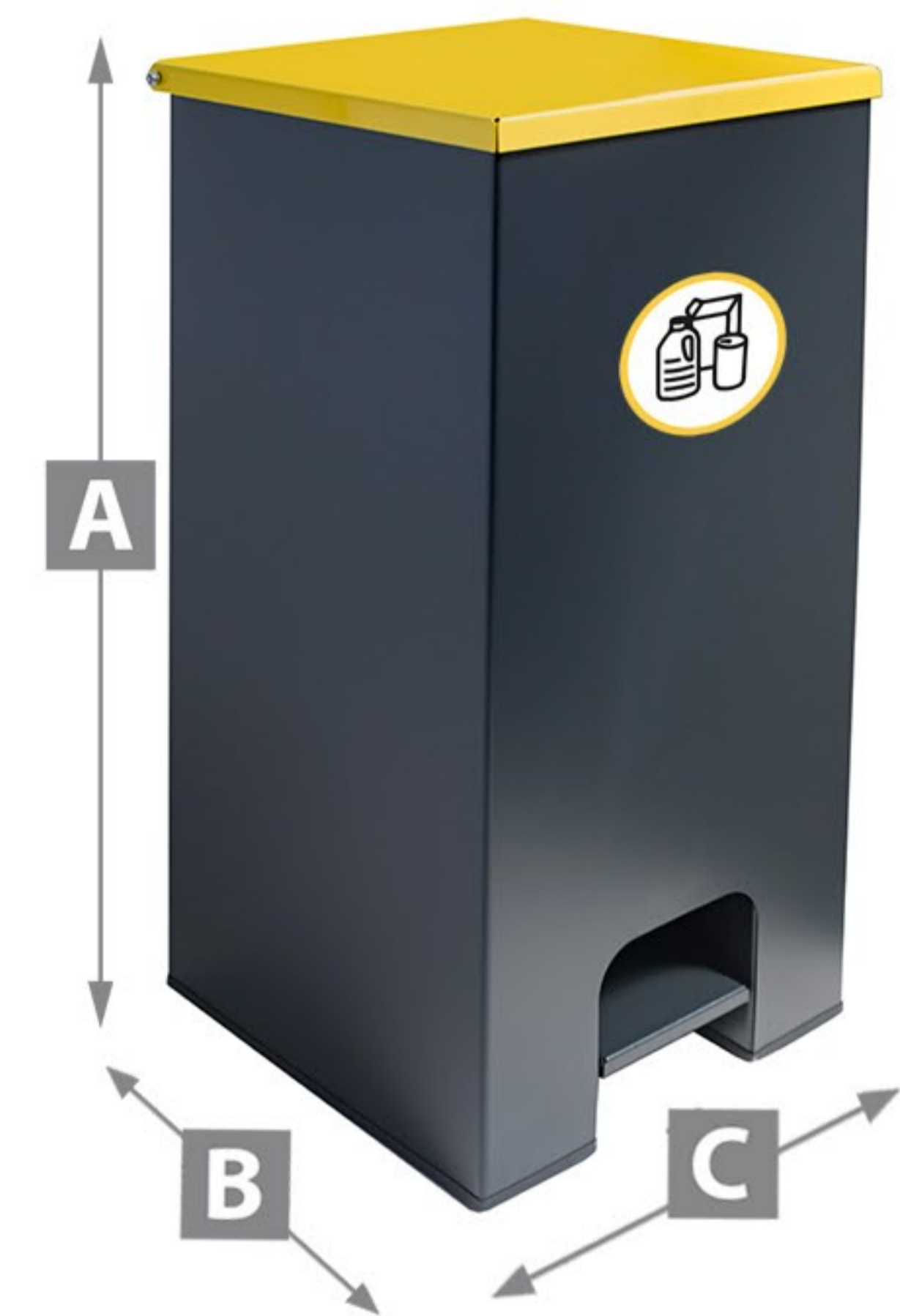

Ref. 5602_ **A** 68,5 cm **B** 34,5 cm **C** 34,5 cm 11,70 Kg **197 €** **60 L**





 **CONTENEDOR INDUSTRIAL METÁLICO CON PEDAL 60 L.**

Contenedor industrial fabricado con chapa de hierro de 1 mm. de espesor.

Tapa superior abatible y aro interior para sujeción de bolsa.

Tapa disponible en 6 colores: Azul, Amarillo, Verde, Marrón, gris y blanco

Medidas: Alto: 68,5 cm. Ancho: 34,5 cm. Fondo: 34,5 cm.

Capacidad 60 Litros.

 **CONTENEUR INDUSTRIEL EN MÉTAL AVEC PÉDALE 60 L.**

Conteneur industriel en tôle de fer 1 mm. d'épaisseur. Couvercle à charnière et bague intérieure pour fixer le sacs poubelles.

Le couvercle est disponible en 6 couleurs : Bleu, jaune, vert, marron, gris et blanc.

Mesures : Hauteur : 68,5 cm. Largeur : 34,5 cm. Profondeur : 34,5 cm.

Capacité 60 litres.

 **INDUSTRIAL METAL CONTAINER WITH PEDAL 60L**

Industrial metal container with a 1mm thick iron plate. Lid swing top and inner ring for fastening bag.

Top available in 6 colors : Blue, Yellow, Green, Brown, Gray and White.

Measurements: Height: 68,5 cm. Width: 34,5 cm. Depth: 34,5 cm.

Capacity 60 Liters.

 **INDUSTRIELLER METALLCONTAINER MIT PEDAL 60L.**

Industrieller Metallcontainer with einer 1mm dicken Eisenplatte. Deckel Swing Top und innerer Ring zur Befestigung der Tasche.

Deckel erhältlich in 7 Farben : Blau, Gelb, Grün, Braun, Grau und Weiß.

Maßnahmen : Höhe: 68,5 cm. Breite: 34,5 cm. Tiefe: 34,5 cm.

Kapazität 60 Liter.

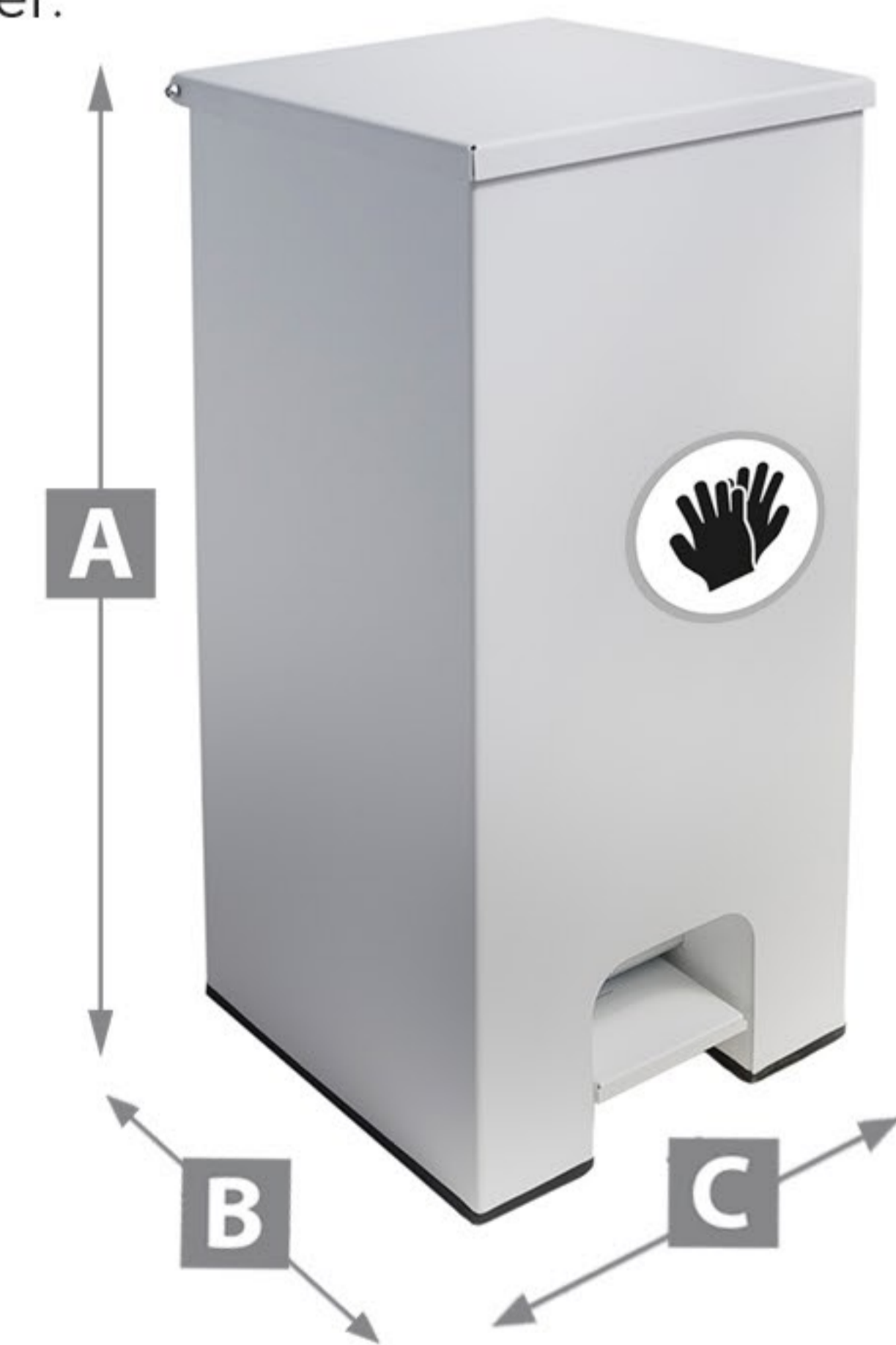

Ref. 5602B_ **A** **B** **C**
 68,5 cm 34,5 cm 34,5 cm 11,70 Kg **197 €** **60 L**





 PAPELERA PARA RECICLAJE

Papelera metálica para reciclaje pintada en color grafito texturado. Tapa superior abatible y 2 depósitos en el interior.

 PAPIER DE RECYCLAGE

Corbeille à papier de recyclage métallique peint en graphite texture. Couvercle à charnière et 2 dépôts à l'intérieur.

 RECYLING BIN

Recycling bin painted in textured graphite color. Lid swing top and 2 deposits inside.

 RECYCLINGPAPIERKORB

Recyclingpapierkorb in texturierte Graphit. Deckel Swing top und 2 Einlagen auf der innenseite.

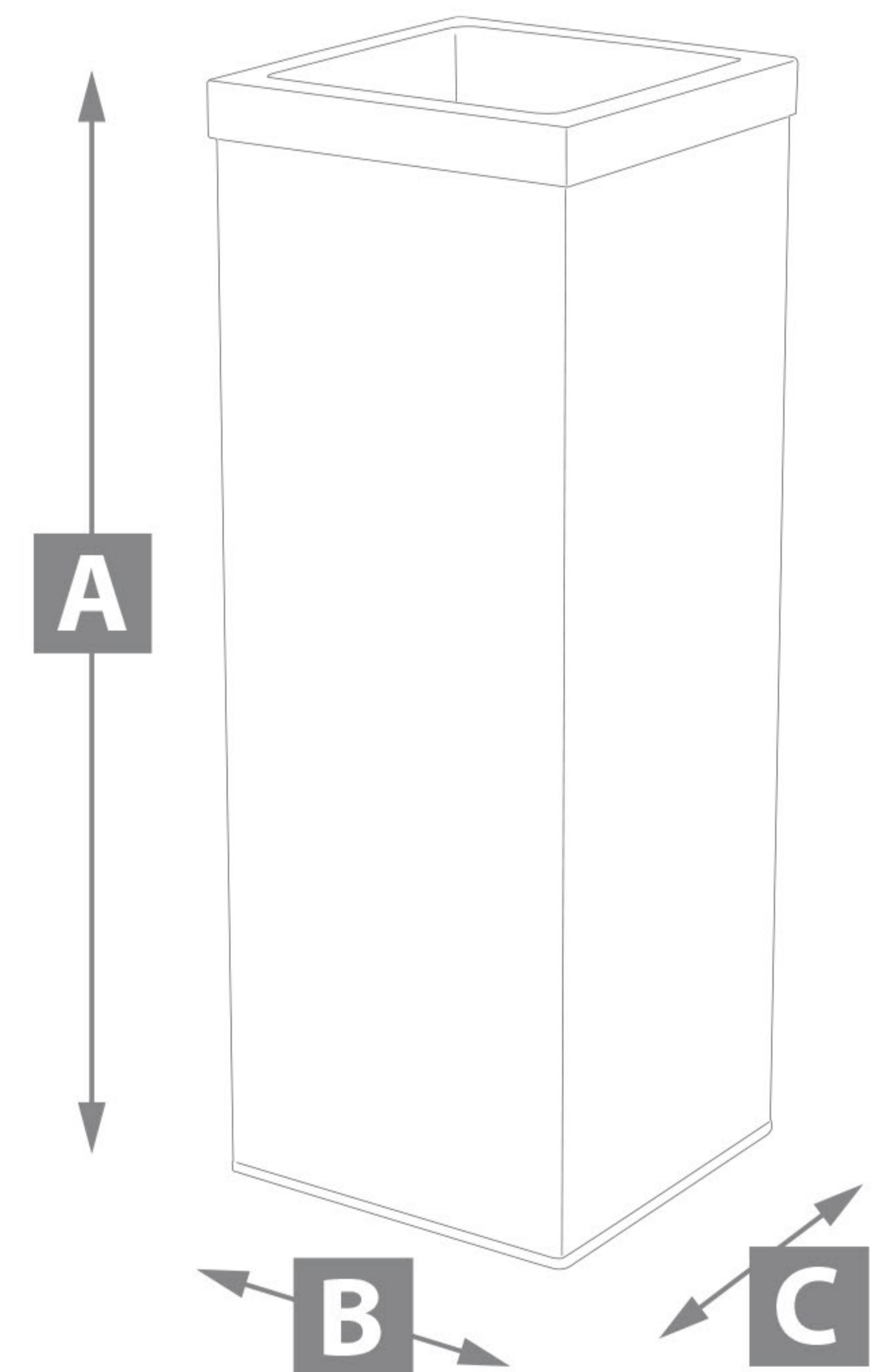

Ref. 5502P_

A

71 cm

B

61 cm

C

31 cm

20.60 Kg

270,00 €

35 L + 35 L





 PAPELERA PARA RECICLAJE

Papelera metálica para reciclaje pintada en color grafito texturado. Tapa superior abatible y 3 depósitos en el interior.

 PAPIER DE RECYCLAGE

Corbeille à papier de recyclage métallique peint en graphite texture. Couvercle à charnière et 3 dépôts à l'intérieur.

 RECYCLING BIN

Recycling bin painted in textured graphite color. Lid swing top and 3 deposits inside.

 RECYCLINGPAPIERKORB

Recyclingpapierkorb in texturierte Graphit. Deckel Swing top und 3 Einlagen auf der Innenseite.

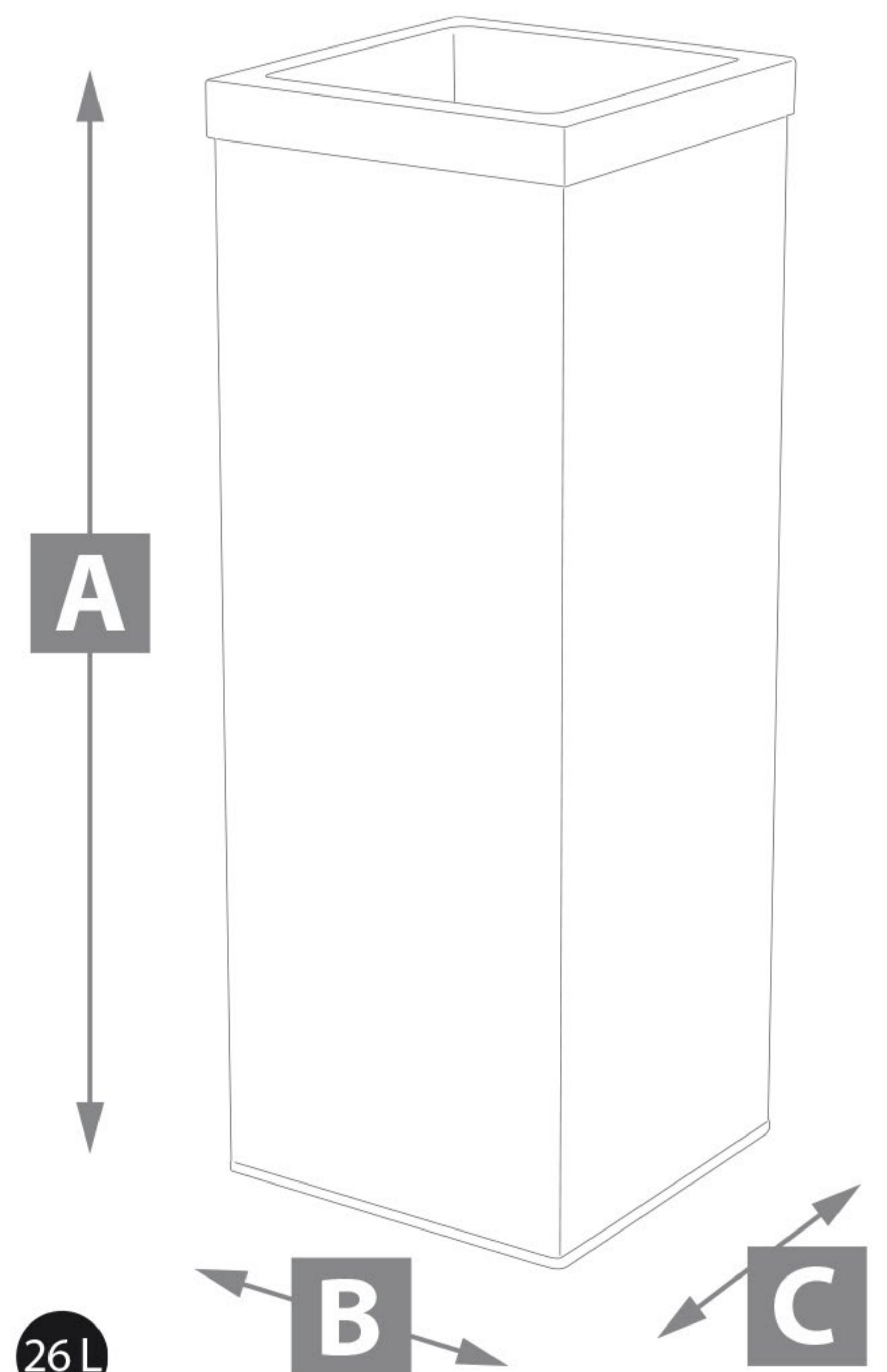
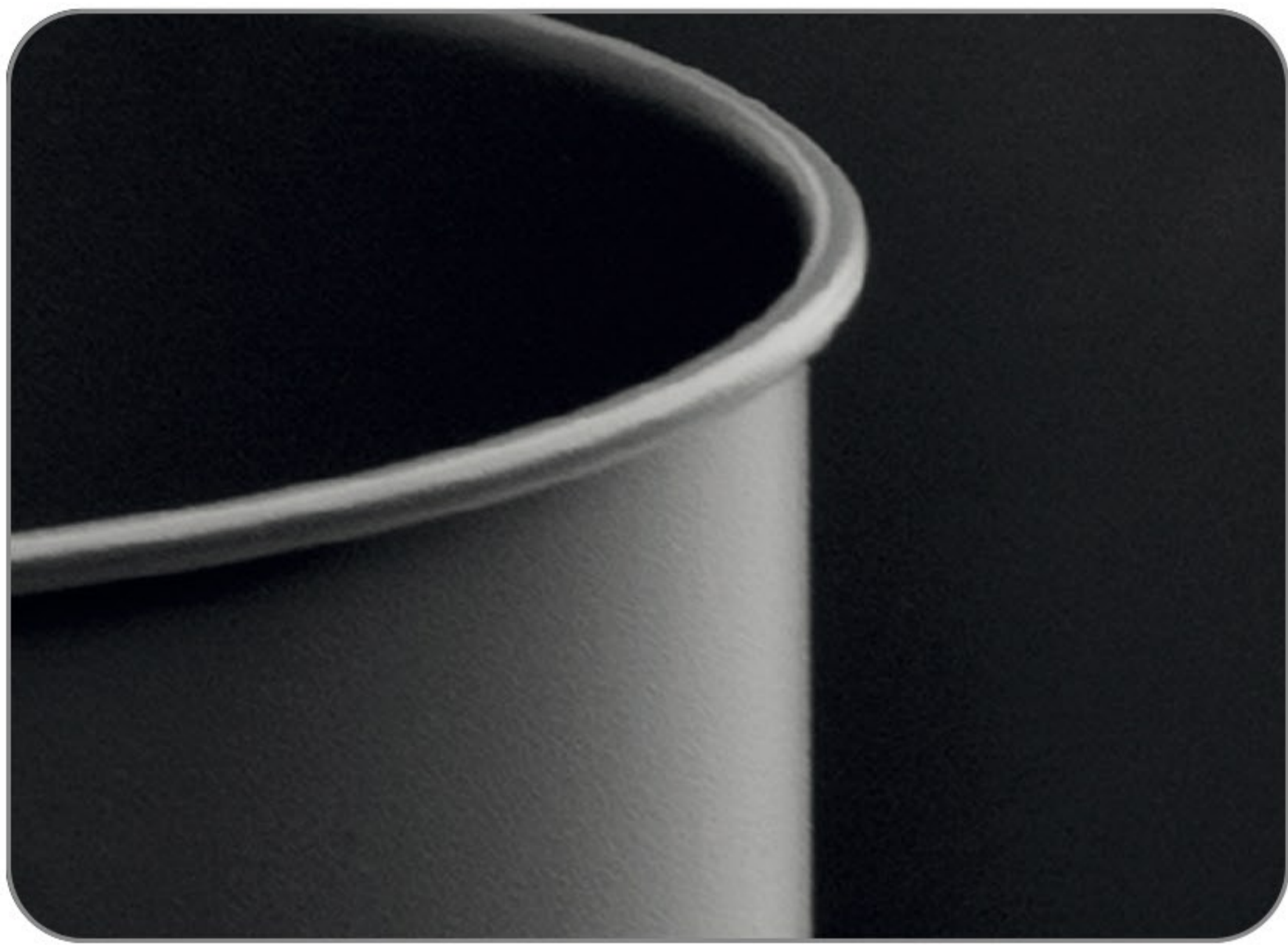

Ref. 2902P_

A
71 cm

B
73,5 cm

C
25,5 cm

25.20 Kg

343,70 €

26L + 26L + 26L





 PAPELERA METÁLICA PARA RECICLAJE

Encajable para facilitar su almacenaje y transporte. Capacidad 50 Litros. / 65 Litros.

 POUBELLE À PÉDALE

Empilable pour faciliter le stockage et le transport. Capacité 50 litres / 65 litres.



 CONTAINER WITH PEDAL

Stackable to facilitate the storing and transport. Capacity 50 Liters / 65 Liters.

 CONTAINER MIT PEDAL

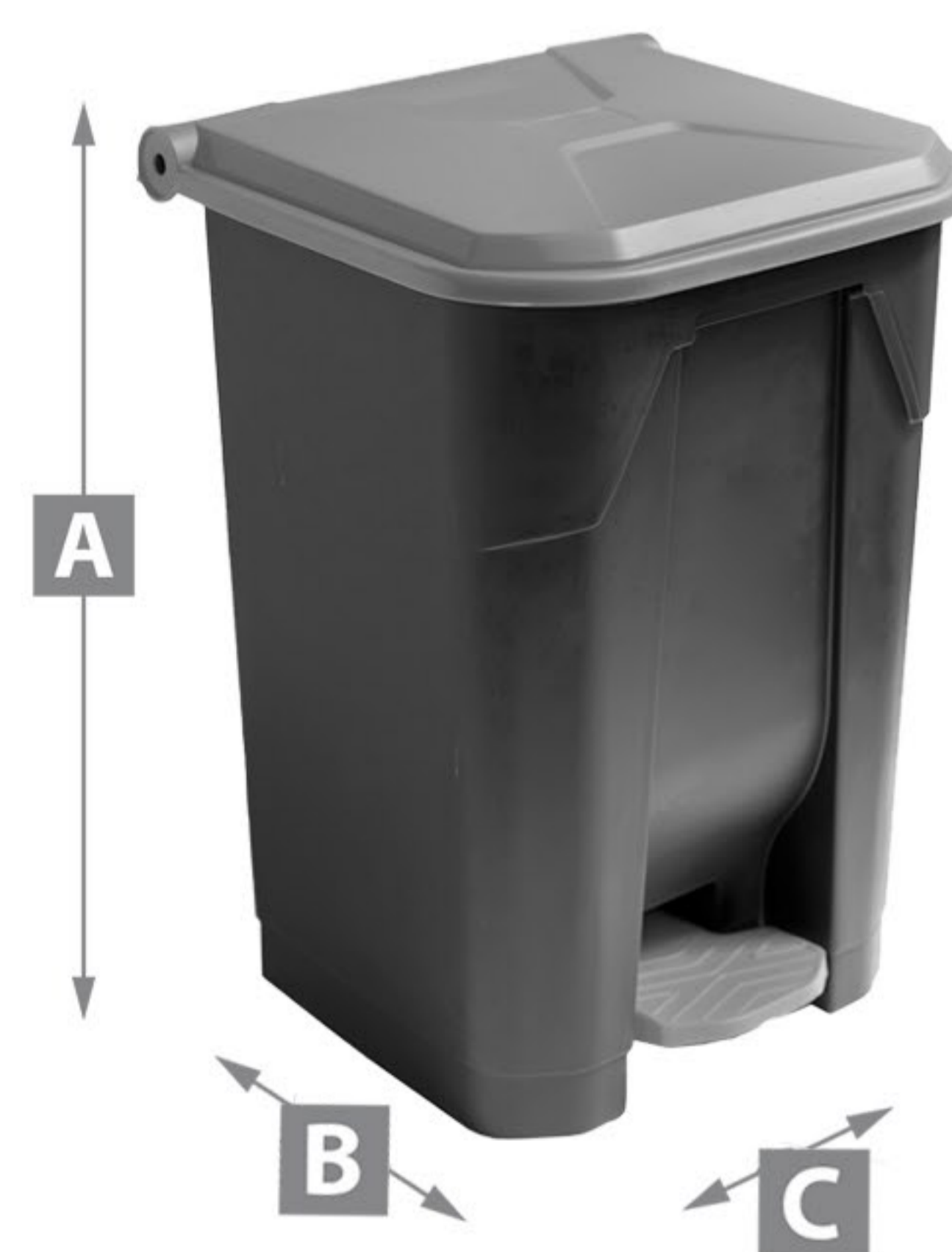
Stapelbar für leichte Lagerung und Transport. Kapazität 50 Liter / 65 Liter.



	A	B	C			
Ref.: CP50	58 cm	40 cm	41,5 cm	2.80 Kg	40,50 €	
Ref.: CP50 AD	58 cm	40 cm	41,5 cm	2.80 Kg	41,80 €	
Ref.: CP65	65 cm	40 cm	48 cm	3.15 Kg	43,75 €	
Ref.: CP65 AD	65 cm	40 cm	48 cm	3.15 Kg	45,44 €	



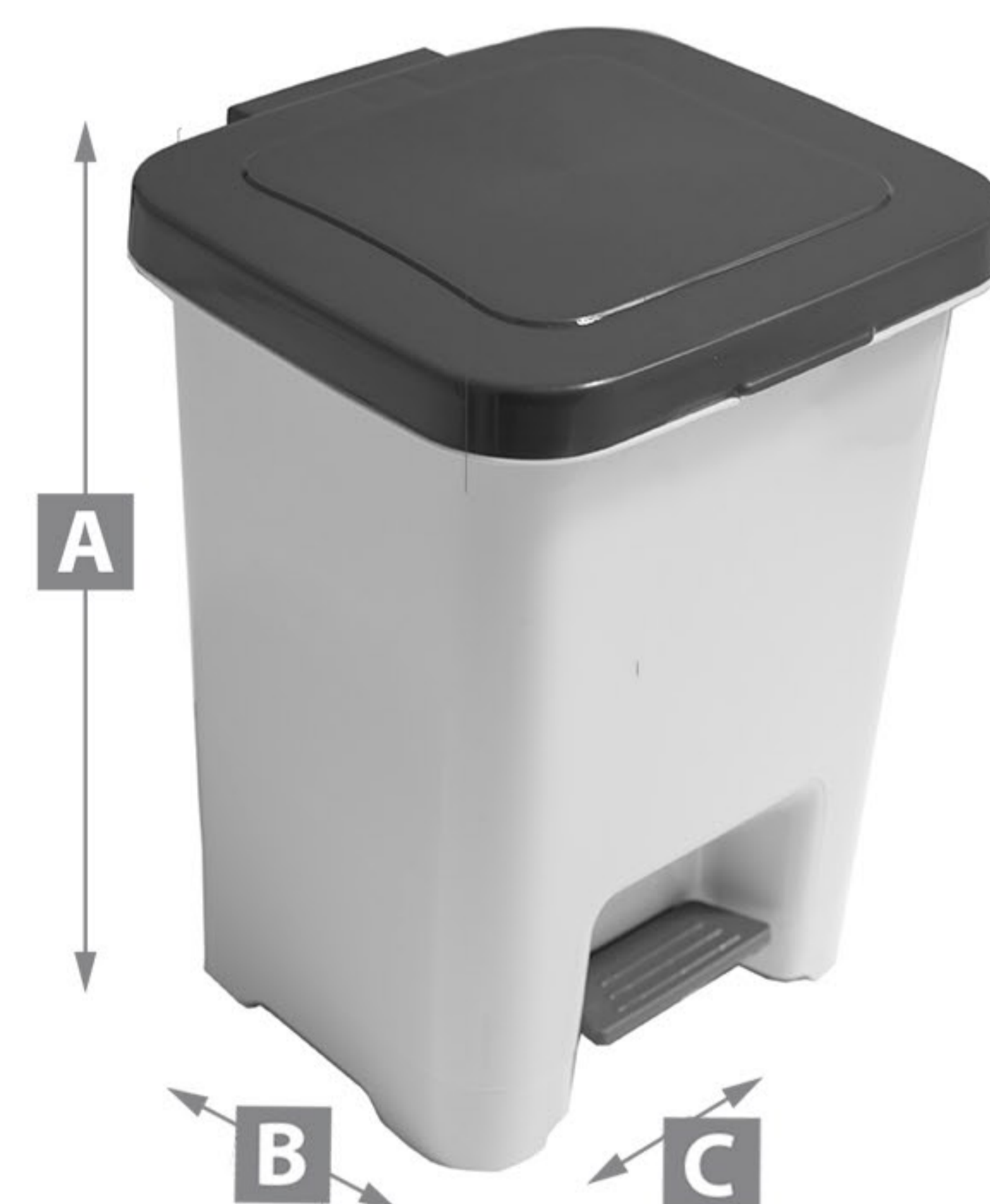

	A	B	C			
Ref.: PPM01	35 cm	26 cm	27,5 cm	1.06 Kg	13,75 €	12L
Ref.: PPM01G	35 cm	26 cm	27,5 cm	1.06 Kg	13,75 €	12L
Ref.: PPM01M	35 cm	26 cm	27,5 cm	1.06 Kg	13,75 €	12L
Ref.: PPM01V	35 cm	26 cm	27,5 cm	1.06 Kg	13,75 €	12L
Ref.: PPM01R	35 cm	26 cm	27,5 cm	1.06 Kg	13,75 €	12L
Ref.: PPM01P	35 cm	26 cm	27,5 cm	1.06 Kg	13,75 €	12L
Ref.: PPM01PL	35 cm	26 cm	27,5 cm	1.06 Kg	13,75 €	12L

 CUBO DE BASURA CON PEDAL 12 LITROS.

Dispone de asas, para la fijación de la bolsa de basura.

 POUBELLE À PÉDALE 12 LITRES.

Il a des poignées pour fixer le sac à poubelles.

 GARBAGE CONTAINER WITH PEDAL 12 LITERS.

It has handles, for fixing the garbage bag.

 ABFALLEIMER MIT PEDAL 12 LITERS.

Es hat Henkel für die Befestigung des Müllsacks.





 CUBO DE BASURA
CON PEDAL 30 LITROS.

Dispone de asas, para la fijación
de la bolsa de basura.

 GARBAGE CONTAINER
WITH PEDAL 30 LITERS.











It has handles, for fixing the
garbage bag.

 POUBELLE À PÉDALE
30 LITRES.

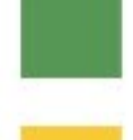
Il a des poignées pour fixer le
sac à poubelles.

 ABFALLEIMER MIT
PEDAL 30 LITERS.

Es hat Henkel für die Befes-
tigung des Müllsacks.

	A	B	C			
Ref.: PP01V	48 cm	37,5 cm	25 cm	1.61 Kg	27,99 €	  30L
Ref.: PP01G	48 cm	37,5 cm	25 cm	1.61 Kg	27,99 €	  30L
Ref.: PP01M	48 cm	37,5 cm	25 cm	1.61 Kg	27,99 €	  30L
Ref.: PP02	48 cm	37,5 cm	25 cm	1.61 Kg	27,99 €	  30L
Ref.: PP03	48 cm	37,5 cm	25 cm	1.61 Kg	27,99 €	  30L





 **CONTENEDOR INDUSTRIAL CON PEDAL 120 L.**

Dispone de asa y ruedas. Encajable para facilitar su almacenaje y transporte. Eje para ruedas realizado en acero galvanizado.

Medidas: Alto: 990 mm. Ancho: 480 mm.
Fondo: 540 mm.
Colores : Azul, Amarillo, Verde, Rojo.
Capacidad 120 Litros

 **POUBELLE INDUSTRIELLE À PÉDALE 120 LITRES.**

Avec poignée et roulettes. Empilable pour faciliter le stockage et le transport.

Mesures : Hauteur : 990 mm. Largeur : 480 mm.
Profondeur : 540 mm.
Couleurs: bleu, jaune, vert, rouge.
Capacité 120 litres

 **INDUSTRIAL CONTAINER WITH PEDAL 120L.**





Has a handle and wheels. Stackable to facilitate the storing and transport.

Measurements: Height: 990 mm. Width: 480 mm.
Depth: 540 mm.
Colors : Blue, Yellow, Green, Red.
Capacity 120 Liters

 **INDUSTRIELLER CONTAINER MIT PEDAL 120L.**

Hat Griff und Räder. Stapelbar für leichte Lagerung und Transport.

Maßnahmen : Höhe: 990 mm. Breite: 480 mm.
Tiefe: 540 mm.
Farben: Blau, Gelb, Grün, Rot.
Kapazität 120 Liter

	A	B	C			
Ref.: CT01	99 cm	54 cm	48 cm	9.10 Kg	68,51 €	 120L
Ref.: CT01V	99 cm	54 cm	48 cm	9.10 Kg	68,51 €	 120L
Ref.: CT01G	99 cm	54 cm	48 cm	9.10 Kg	68,51 €	 120L
Ref.: CT01M	99 cm	54 cm	48 cm	9.10 Kg	68,51 €	 120L
Ref.: CT02	99 cm	54 cm	48 cm	9.10 Kg	68,51 €	 120L
Ref.: CT03	99 cm	54 cm	48 cm	9.10 Kg	68,51 €	 120L
Ref.: CT04	99 cm	54 cm	48 cm	9.10 Kg	68,51 €	 120L





Ref. CP60 AD (03) ■■

 CONTENEDOR CON PEDAL DE 60, 80 Y 120 LITROS.

Contenedor con pedal de 60, 80 y 120 Litros, útil para la recogida y clasificación de residuos para todo tipo de negocios. Dispone de pedal para la apertura de la tapa. Dos ruedas y un asa facilitan su desplazamiento, contenedor apilable.

Especificaciones técnicas Material de base Rango de temperatura PEAD -40°/80°C
Uso alimentario: Sí

Se fabrica con el Contenedor en color gris y la tapa en color negro, rojo, amarillo, azul y verde. También se suministra con el contenedor y la tapa en color blanco.

 CONTENEUR À PÉDALE DE 60, 80 ET 120 LITRES.

Conteneur à pédale, utile pour collecter et classer les déchets pour tous types d'entreprises. Il a une pédale pour ouvrir le couvercle. Deux roues et une poignée facilitent le déplacement, le conteneur est empilable. Disponible en 60, 80 et 120 litres.

Spécifications techniques Matériel de base écart de température PEHD -40° / 80°C
Utilisation alimentaire: Oui

Il est fabriqué avec le conteneur en gris et le couvercle en noir, rouge, jaune, bleu et vert. Il est également fourni avec le conteneur et le couvercle en blanc.

 CONTAINER WITH PEDAL.60, 80 AND 120 LITRES

Container with pedal, useful for the collection and classification of waste for all types of businesses. It has a pedal for opening the lid. Two wheels and a handle make it easy to move, stackable container. Available in 60, 80 and 120 litres.

Technical specifications: Base material PEAD temperature range -40o/80oC
Food use: Yes

It is manufactured with the container in gray and the cover in black, red, yellow, blue and green. It is also supplied with the container and the lid in white.

 BEHÄLTER MIT PEDAL. 60, 80 UND 120 LITER

Behälter mit Pedal, nützlich für die Sammlung und Klassifizierung von Abfällen für alle Arten von Unternehmen. Er hat ein Pedal zum Öffnen des Deckels. Zwei Räder und ein Griff machen es einfach zu verschieben, stapelbarer Behälter. Lieferbar in 60, 80 und 120 Liter.

Technische Daten: Basismaterial PEAD Temperaturbereich -40°/80°C
Verwendung bei Lebensmittel: Ja

Der Behälter wird in grau hergestellt und der Deckel in schwarz, rot, gelb, blau und grün. Der Behälter und der Deckel werden auch in weiß geliefert.



Ref. CP120 □□

	A	B	C			
Ref.: CP60	71 cm	38 cm	50 cm	3,70 Kg	43,93 €	60 L
Ref.: CP60 AD	71 cm	38cm	50 cm	3,70 Kg	45,08 €	60 L
Ref.: CP80	74 cm	50 cm	43 cm	4,30 Kg	47,00 €	80 L
Ref.: CP80 AD	74cm	50 cm	43 cm	4,30 Kg	48,15 €	80 L
Ref.: CP120	87,5 cm	42,5 cm	51 cm	5,43 Kg	57,82 €	120L
Ref.: CP120 AD	87,5 cm	42,5 cm	52 cm	5,43 Kg	58,97 €	120L

- 60 L
- 60 L
- 80 L
- 80 L
- 120L
- 120L



 MAMPARA DE PROTECCIÓN ANTICONTAGIOS

Producto ideal para cualquier tipo de negocio, para ser situado en el mostrador o sujeto al techo.

La mampara está fabricada con metacrilato de 3 mm. de grosor y los dos soportes son de 6 mm. de grosor para conseguir una mejor estabilidad.

Fácil montaje, transporte y limpieza de las mamparas de protección.

 ACRYLIC PROTECTION SCREEN

Protection screen made of transparent methacrylate. Ideal product for any type of business, to be located on the counter or subject to the ceiling.

The screen is made of 3 mm methacrylate. The two brackets are 6 mm thick. Thickness for better stability.

Easy assembly, transport and cleaning of protective screens.

 ÉCRAN DE PROTECTION ANTI-CONTAGION

Écran de protection anti-pollution/anti-contagion en méthacrylate transparent. Element idéal pour tout type d'entreprise, à poser sur le comptoir ou à fixer au plafond.

L'écran est en méthacrylate de 3 mm. d'épaisseur et les deux supports sont de 6 mm. pour une meilleure stabilité. Montage, transport et nettoyage faciles des écrans de protection.

 ANTI-ANSTECKUNG-SCHUTZSCHIRM

Anti-Ansteckung-Schutzschirm aus transparentem Methacrylat.

Ideales Produkt für jede Art von Geschäft. Auf der Theke oder unter der Decke anzubringen. Der Schutzschirm besteht aus 3mm dickem Methacrylat. Die beiden Stützen haben eine Dicke von 6 mm für bessere Stabilität.

Einfache Montage, Transport und Reinigung von Schutzschirmen.

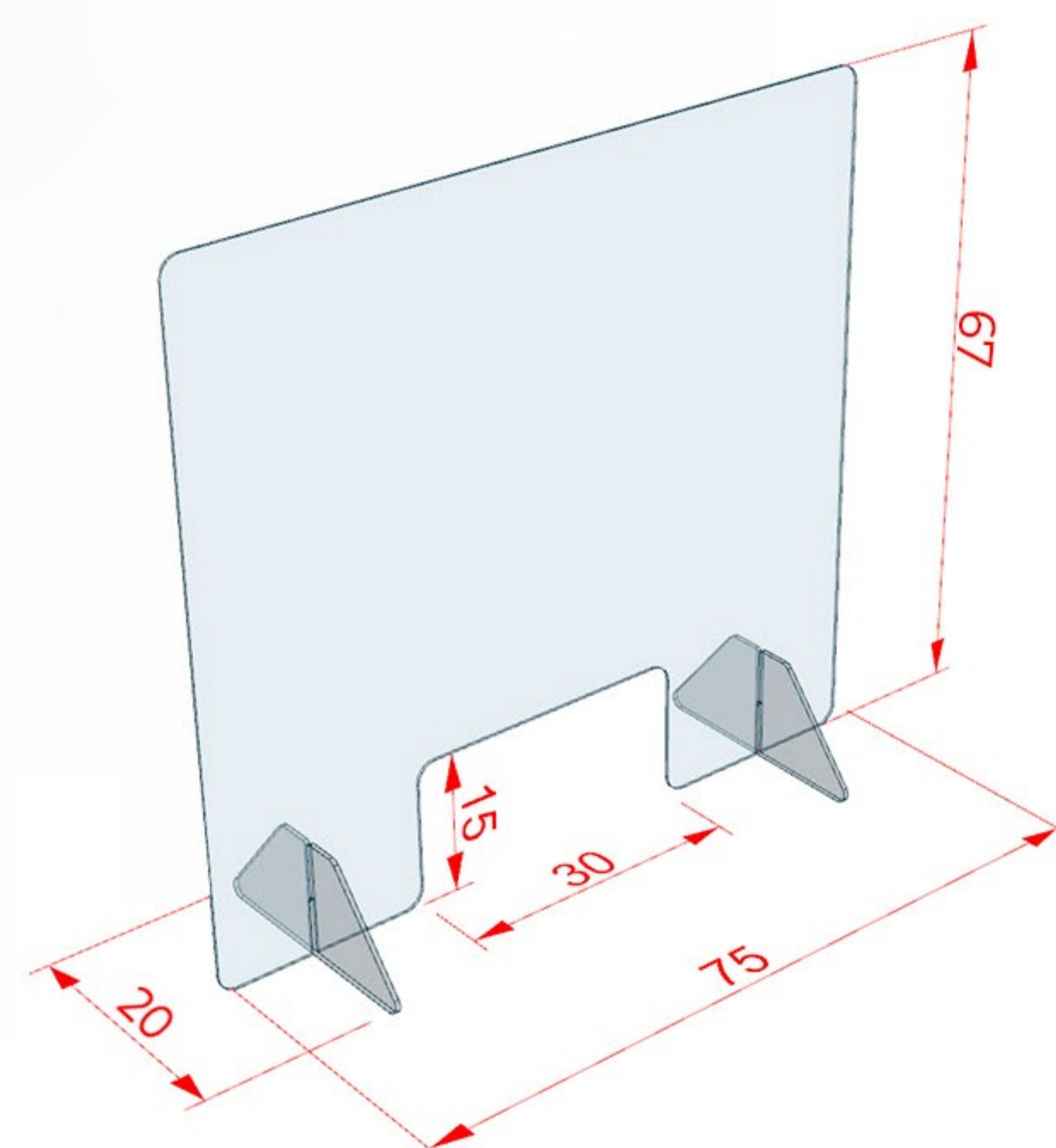

67 cm x 75 cm x 20 cm

Ref.: MPA1

 1.00 Kg

 **59,80 €**

 MAMPARA DE PROTECCIÓN ANTICONTAGIOS

Producto ideal para cualquier tipo de negocio, para ser situado en el mostrador o sujeto al techo.

La mampara está fabricada con metacrilato de 3 mm. de grosor y los dos soportes son de 6 mm. de grosor para conseguir una mejor estabilidad.

Fácil montaje, transporte y limpieza de las mamparas de protección.

 ACRYLIC PROTECTION SCREEN

Protection screen made of transparent methacrylate. Ideal product for any type of business, to be located on the counter or subject to the ceiling.

The screen is made of 3 mm methacrylate. The two brackets are 6 mm thick. Thickness for better stability.

Easy assembly, transport and cleaning of protective screens.

 ÉCRAN DE PROTECTION ANTI-CONTAGION

Écran de protection anti-pollution/anti-contagion en méthacrylate transparent. Element idéal pour tout type d'entreprise, à poser sur le comptoir ou à fixer au plafond.

L'écran est en méthacrylate de 3 mm. d'épaisseur et les deux supports sont de 6 mm. pour une meilleure stabilité. Montage, transport et nettoyage faciles des écrans de protection.

 ANTI-ANSTECKUNG-SCHUTZSCHIRM

Anti-Ansteckung-Schutzschirm aus transparentem Methacrylat.

Ideales Produkt für jede Art von Geschäft. Auf der Theke oder unter der Decke anzubringen. Der Schutzschirm besteht aus 3mm dickem Methacrylat. Die beiden Stützen haben eine Dicke von 6 mm für bessere Stabilität.

Einfache Montage, Transport und Reinigung von Schutzschirmen.

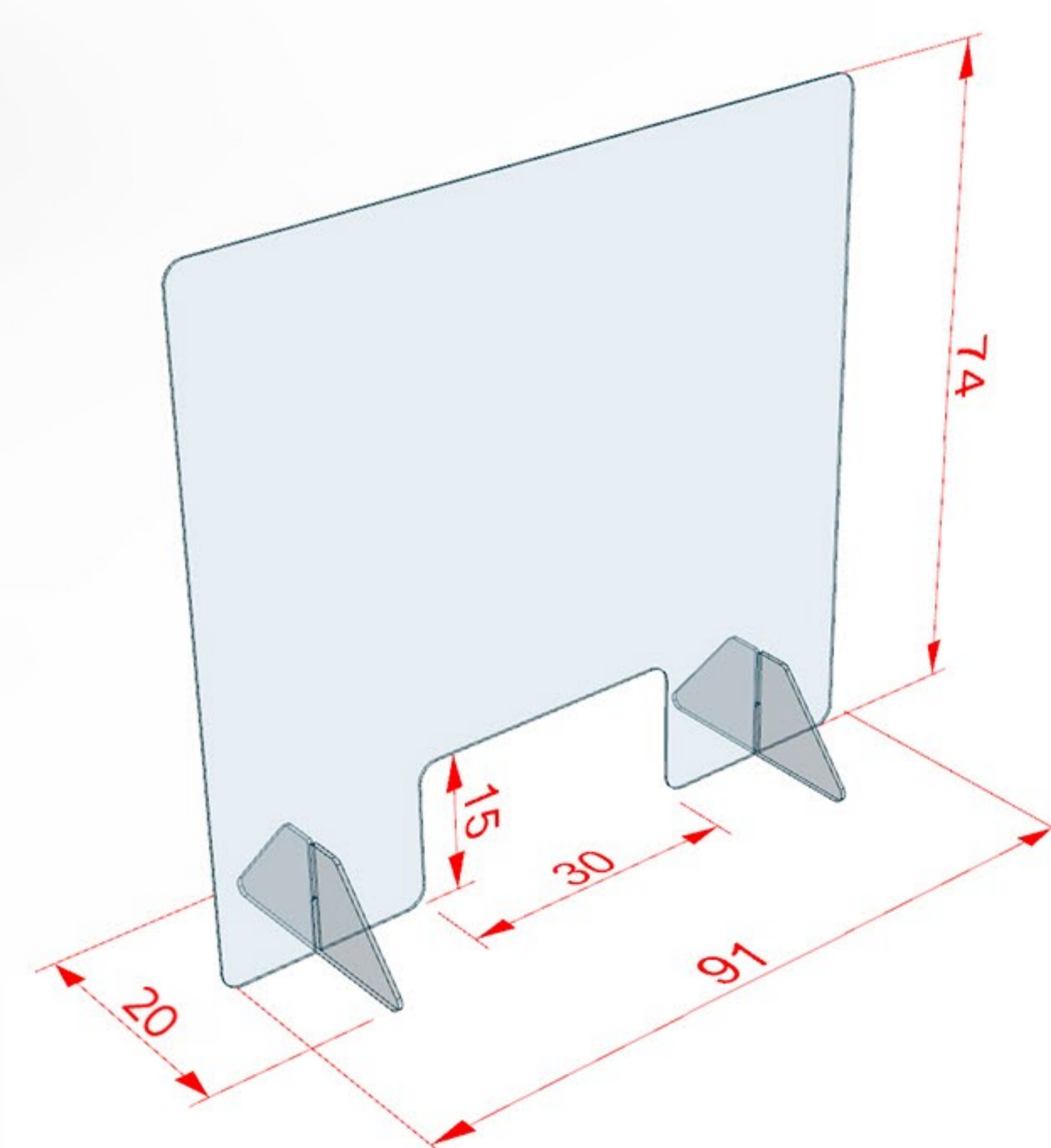

74 cm x 91 cm x 20 cm

Ref.: MPA2

 1.00 Kg

 **79,90 €**

 MAMPARA DE PROTECCIÓN ANTICONTAGIOS

Producto ideal para cualquier tipo de negocio, para ser situado en el mostrador o sujeto al techo.

La mampara está fabricada con metacrilato de 4 mm. de grosor y los dos soportes son de 6 mm. de grosor para conseguir una mejor estabilidad.

Fácil montaje, transporte y limpieza de las mamparas de protección.

 ACRYLIC PROTECTION SCREEN

Protection screen made of transparent methacrylate. Ideal product for any type of business, to be located on the counter or subject to the ceiling.

The screen is made of 4 mm methacrylate. The two brackets are 6 mm thick. Thickness for better stability.

Easy assembly, transport and cleaning of protective screens.

 ÉCRAN DE PROTECTION ANTI-CONTAGION

Écran de protection anti-pollution/anti-contagion en méthacrylate transparent. Element idéal pour tout type d'entreprise, à poser sur le comptoir ou à fixer au plafond.

L'écran est en méthacrylate de 4 mm. d'épaisseur et les deux supports sont de 6 mm. pour une meilleure stabilité. Montage, transport et nettoyage faciles des écrans de protection.

 ANTI-ANSTECKUNG-SCHUTZSCHIRM

Anti-Ansteckung-Schutzschirm aus transparentem Methacrylat.

Ideales Produkt für jede Art von Geschäft. Auf der Theke oder unter der Decke anzubringen. Der Schutzschirm besteht aus 4 mm dickem Methacrylat. Die beiden Stützen haben eine Dicke von 6 mm für bessere Stabilität.

Einfache Montage, Transport und Reinigung von Schutzschirmen.

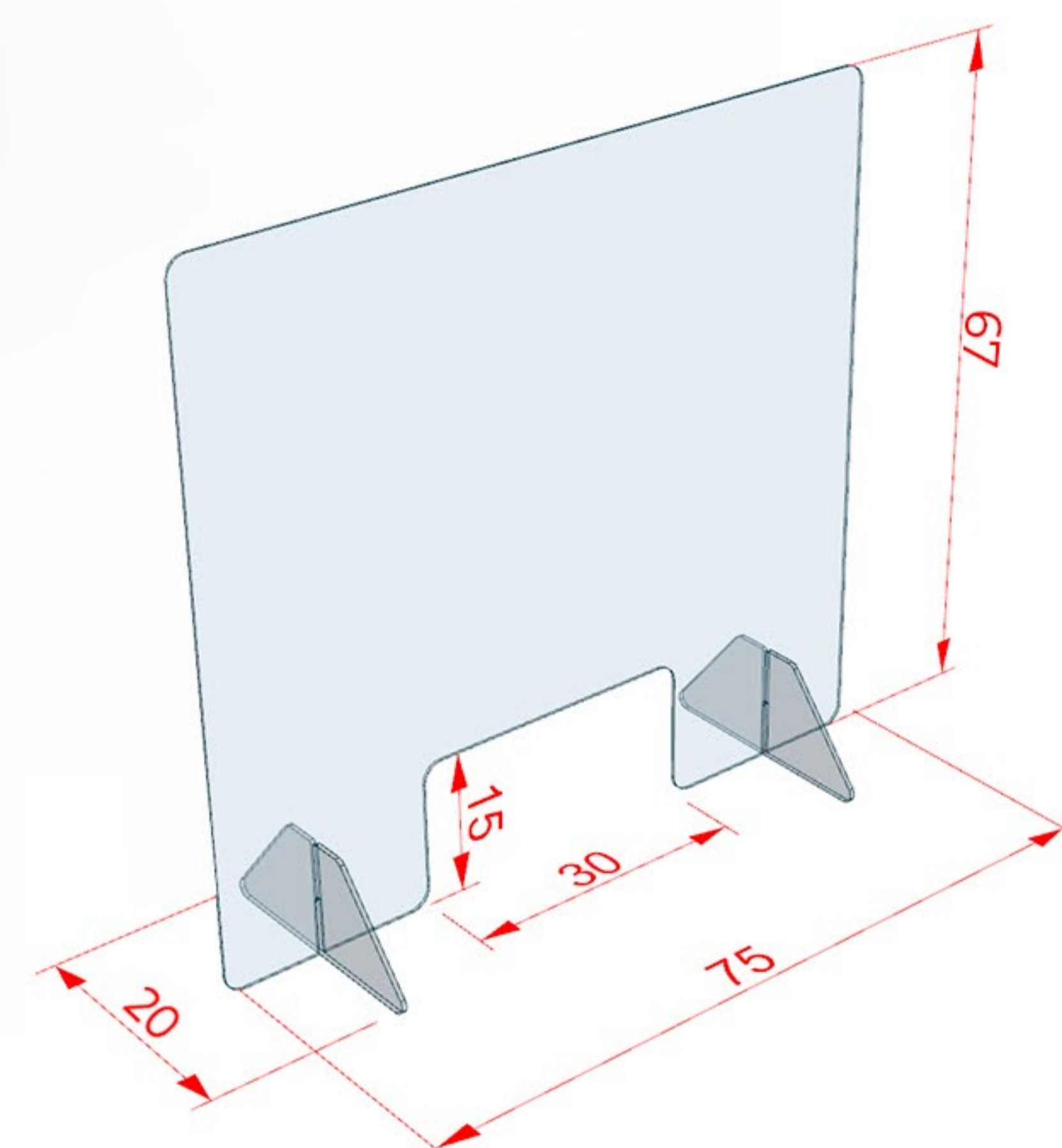

67 cm x 75 cm x 20 cm

Ref.: MPA3

 1.00 Kg

 **73,09 €**

 MAMPARA DE PROTECCIÓN ANTICONTAGIOS

Producto ideal para cualquier tipo de negocio, para ser situado en el mostrador o sujeto al techo.

La mampara está fabricada con metacrilato de 4 mm. de grosor y los dos soportes son de 6 mm. de grosor para conseguir una mejor estabilidad.

Fácil montaje, transporte y limpieza de las mamparas de protección.

 ACRYLIC PROTECTION SCREEN

Protection screen made of transparent methacrylate. Ideal product for any type of business, to be located on the counter or subject to the ceiling.

The screen is made of 4 mm methacrylate. The two brackets are 6 mm thick. Thickness for better stability.

Easy assembly, transport and cleaning of protective screens.

 ÉCRAN DE PROTECTION ANTI-CONTAGION

Écran de protection anti-pollution/anti-contagion en méthacrylate transparent. Element idéal pour tout type d'entreprise, à poser sur le comptoir ou à fixer au plafond.

L'écran est en méthacrylate de 4 mm. d'épaisseur et les deux supports sont de 6 mm. pour une meilleure stabilité. Montage, transport et nettoyage faciles des écrans de protection.

 ANTI-ANSTECKUNG-SCHUTZSCHIRM

Anti-Ansteckung-Schutzschirm aus transparentem Methacrylat.

Ideales Produkt für jede Art von Geschäft. Auf der Theke oder unter der Decke anzubringen. Der Schutzschirm besteht aus 4 mm dickem Methacrylat. Die beiden Stützen haben eine Dicke von 6 mm für bessere Stabilität.

Einfache Montage, Transport und Reinigung von Schutzschirmen.

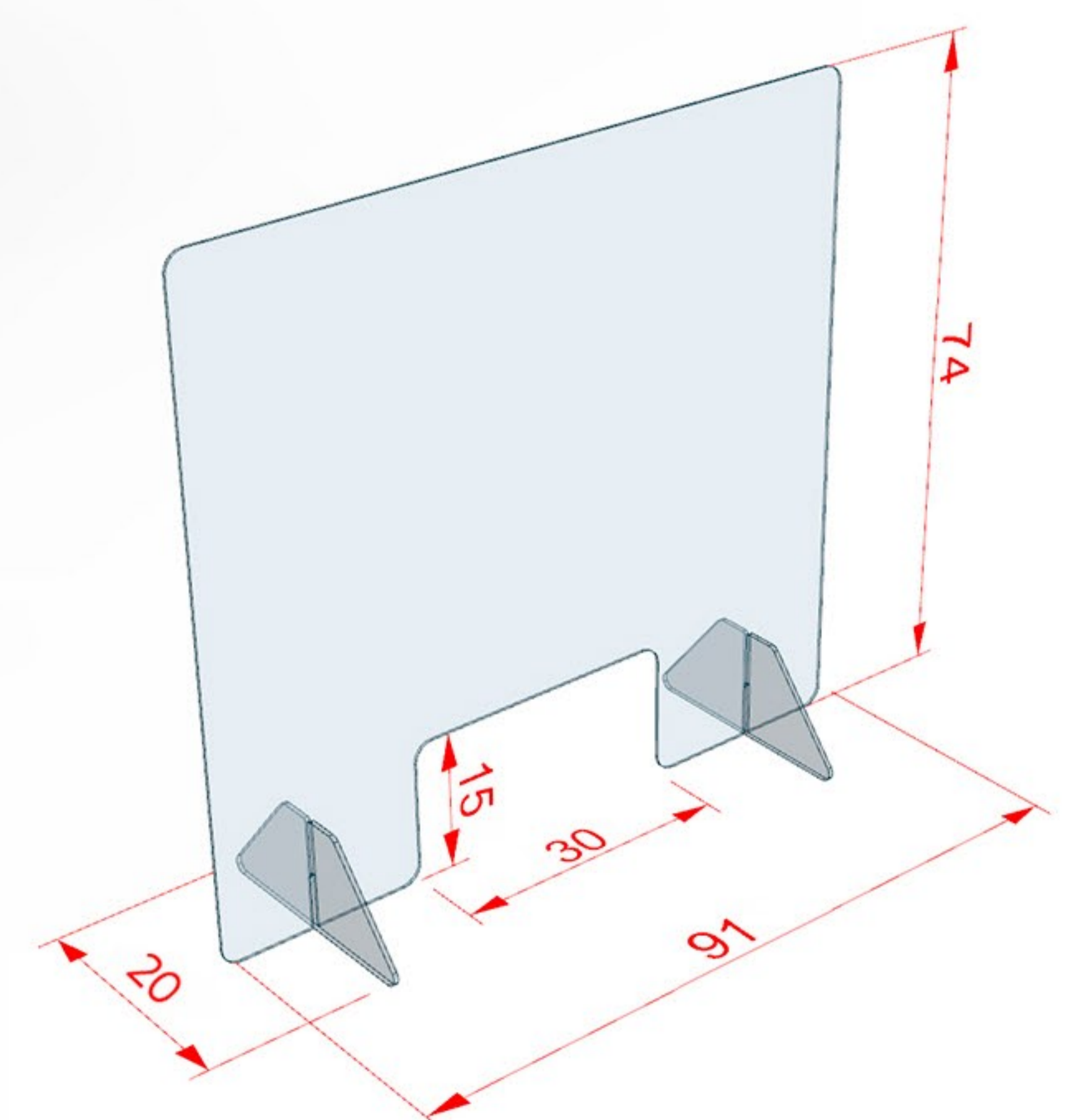

74 cm x 91 cm x 20 cm

Ref.: MPA4

 1.00 Kg

 **99,88 €**

 MAMPARA DIVISORIA DE PIE

Mampara divisoria de protección anti contagios. Estructura metálica pintada en color plata con panel fabricado en metacrilato transparente de 3 mm. de grosor.

Producto ideal para cualquier tipo de negocio, útil para la separación y delimitación de espacios. Fácil montaje, transporte y limpieza de la mampara de pie.

Producto personalizable: podemos ofrecer la posibilidad de crear un producto personalizado a medida (consultar).

 STANDING DIVIDING PROTECTION SHIELD

Anti-contagious dividing protection shield. Metallic structure painted with silver paint with a panel manufactured in transparent 3mm thick methacrylate.

Ideal product for any type of business. Useful for the separation and limitation of spaces. Easy assembly, transport and cleaning of the standing protection shield.

Personalized product: we can offer the possibility of creating a personalized custom made product (consult us).

 CLOISON SÉPARANT SUR PIED

Cloison de séparation anti contagion. Structure métallique peinte en couleur argent avec panneau en méthacrylate transparent de 3 mm. d'épaisseur.

Produit idéal pour tout type d'entreprise, utile pour la séparation et la délimitation d'espaces. Assemblage, transport et nettoyage faciles.

Produit personnalisable: nous pouvons offrir la possibilité de créer un produit sur mesure (consultar).

 STEHENDE TRENNWAND

Anti Ansteckung Trennwand. Metallstruktur in silberner Farbe hergestellt in durchsichtigem 3mm dickem Methacrylat.

Ideales Produkt für jegliches Geschäft. Nützlich für die Trennung und Beschränkung von Plätzen. Leichtes Montieren, Transport und Reinigung der stehenden Trennwand.

Personalisiertes Produkt: wir können die Möglichkeit anbieten, ein persönliches nach Maß angefertigtes Produkt anzubieten (bitte anfragen).



180 cm x 100 cm x 45 cm

Ref.: MPA5

 13,10 Kg

 **353,85 €**



 MAMPARA DIVISORIA DE PIE

Mampara divisoria de protección anti contagios. Estructura metálica pintada en color plata con panel fabricado en metacrilato transparente de 3 mm. de grosor.

Producto ideal para cualquier tipo de negocio, útil para la separación y delimitación de espacios. Fácil montaje, transporte y limpieza de la mampara de pie.

Producto personalizable: podemos ofrecer la posibilidad de crear un producto personalizado a medida (consultar).

 STANDING DIVIDING PROTECTION SHIELD

Anti-contagious dividing protection shield. Metallic structure painted with silver paint with a panel manufactured in transparent 3mm thick methacrylate.

Ideal product for any type of business. Useful for the separation and limitation of spaces. Easy assembly, transport and cleaning of the standing protection shield.

Personalized product: we can offer the possibility of creating a personalized custom made product (consult us).

 CLOISON SÉPARANT SUR PIED

Cloison de séparation anti contagion. Structure métallique peinte en couleur argent avec panneau en méthacrylate transparent de 3 mm. d'épaisseur.

Produit idéal pour tout type d'entreprise, utile pour la séparation et la délimitation d'espaces. Assemblage, transport et nettoyage faciles.

Produit personnalisable: nous pouvons offrir la possibilité de créer un produit sur mesure (consulter).

 STEHENDE TRENNWAND

Anti Ansteckung Trennwand. Metallstruktur in silberner Farbe hergestellt in durchsichtigem 3mm dickem Methacrylat.

Ideales Produkt für jegliches Geschäft. Nützlich für die Trennung und Beschränkung von Plätzen. Leichtes Montieren, Transport und Reinigung der stehenden Trennwand.

Personalisiertes Produkt: wir können die Möglichkeit anbieten, ein persönliches nach Maß angefertigtes Produkt anzubieten (bitte anfragen).



180 cm x 100 cm x 45 cm

Ref.: MPA51

 12,98 Kg

 **298,25 €**

 MAMPARA DIVISORIA DE PIE

Mampara divisoria de protección anti contagios. Estructura metálica pintada en color plata con panel fabricado en metacrilato transparente de 3 mm. de grosor.

Producto ideal para cualquier tipo de negocio, útil para la separación y delimitación de espacios. Fácil montaje, transporte y limpieza de la mampara de pie.

Producto personalizable: podemos ofrecer la posibilidad de crear un producto personalizado a medida (consultar).

 STANDING DIVIDING PROTECTION SHIELD

Anti-contagious dividing protection shield. Metallic structure painted with silver paint with a panel manufactured in transparent 3mm thick methacrylate.

Ideal product for any type of business. Useful for the separation and limitation of spaces. Easy assembly, transport and cleaning of the standing protection shield.

Personalized product: we can offer the possibility of creating a personalized custom made product (consult us).

 CLOISON SÉPARANT SUR PIED

Cloison de séparation anti contagion. Structure métallique peinte en couleur argent avec panneau en méthacrylate transparent de 3 mm. d'épaisseur.

Produit idéal pour tout type d'entreprise, utile pour la séparation et la délimitation d'espaces. Assemblage, transport et nettoyage faciles.

Produit personnalisable: nous pouvons offrir la possibilité de créer un produit sur mesure (consultar).

 STEHENDE TRENNWAND

Anti Ansteckung Trennwand. Metallstruktur in silberner Farbe hergestellt in durchsichtigem 3mm dickem Methacrylat.

Ideales Produkt für jegliches Geschäft. Nützlich für die Trennung und Beschränkung von Plätzen. Leichtes Montieren, Transport und Reinigung der stehenden Trennwand.

Personalisiertes Produkt: wir können die Möglichkeit anbieten, ein persönliches nach Maß angefertigtes Produkt anzubieten (bitte anfragen).

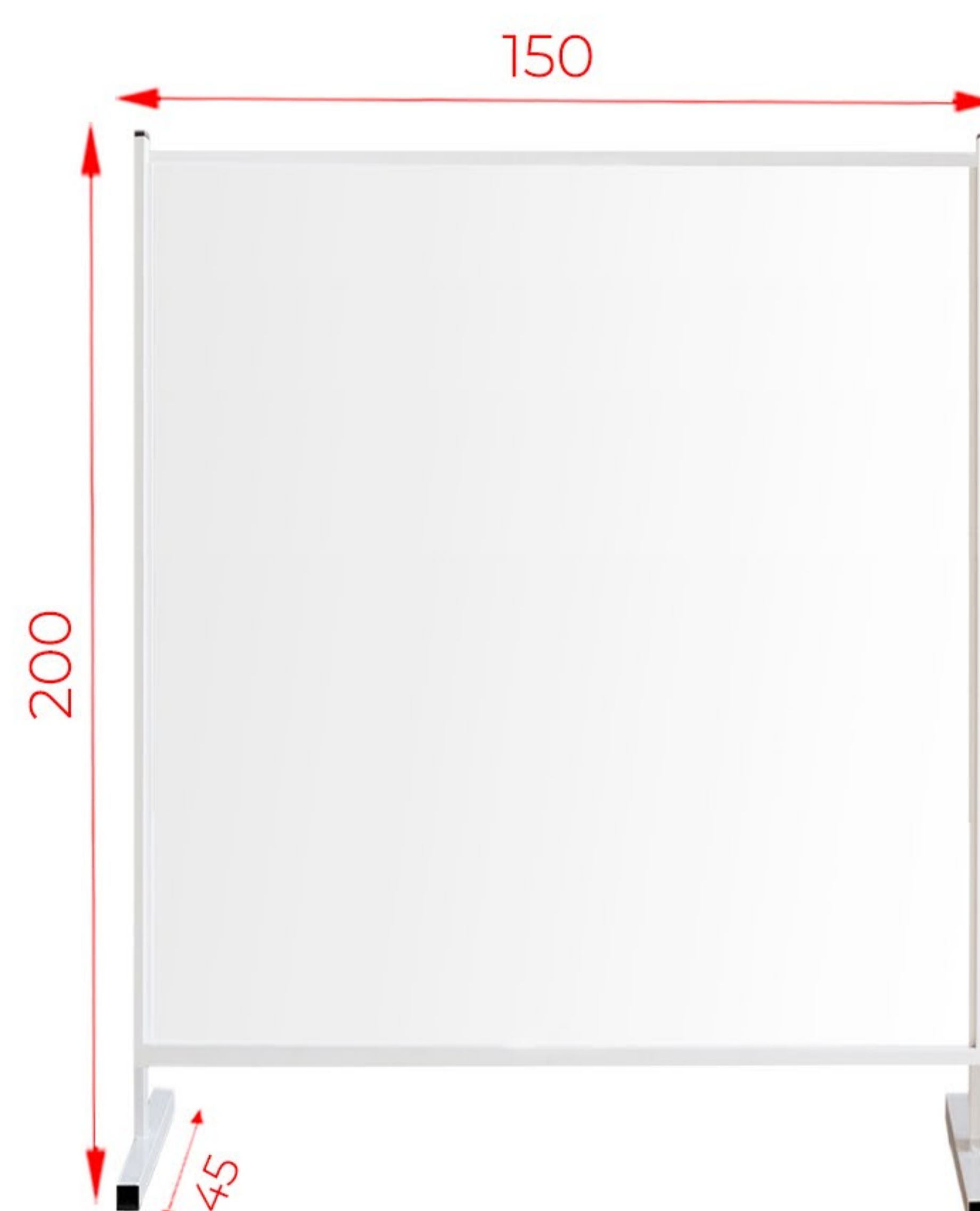

200 cm x 150 cm x 45 cm. (3 mm)

Ref.: MPA6

 14,10 Kg

 **399,50 €**

 MAMPARA DIVISORIA DE PIE

Mampara divisoria de protección anti contagios. Estructura metálica pintada en color plata con panel fabricado en metacrilato transparente de 3 mm. de grosor.

Producto ideal para cualquier tipo de negocio, útil para la separación y delimitación de espacios. Fácil montaje, transporte y limpieza de la mampara de pie.

Producto personalizable: podemos ofrecer la posibilidad de crear un producto personalizado a medida (consultar).

 STANDING DIVIDING PROTECTION SHIELD

Anti-contagious dividing protection shield. Metallic structure painted with silver paint with a panel manufactured in transparent 3mm thick methacrylate.

Ideal product for any type of business. Useful for the separation and limitation of spaces. Easy assembly, transport and cleaning of the standing protection shield.

Personalized product: we can offer the possibility of creating a personalized custom made product (consult us).

 CLOISON SÉPARANT SUR PIED

Cloison de séparation anti contagion. Structure métallique peinte en couleur argent avec panneau en méthacrylate transparent de 3 mm. d'épaisseur.

Produit idéal pour tout type d'entreprise, utile pour la séparation et la délimitation d'espaces. Assemblage, transport et nettoyage faciles.

Produit personnalisable: nous pouvons offrir la possibilité de créer un produit sur mesure (consulter).

 STEHENDE TRENNWAND

Anti Ansteckung Trennwand. Metallstruktur in silberner Farbe hergestellt in durchsichtigem 3mm dickem Methacrylat.

Ideales Produkt für jegliches Geschäft. Nützlich für die Trennung und Beschränkung von Plätzen. Leichtes Montieren, Transport und Reinigung der stehenden Trennwand.

Personalisiertes Produkt: wir können die Möglichkeit anbieten, ein persönliches nach Maß angefertigtes Produkt anzubieten (bitte anfragen).



206 cm x 150 cm x 45 cm

Ref.: MPA7

 14,30 Kg

 **403,91 €**

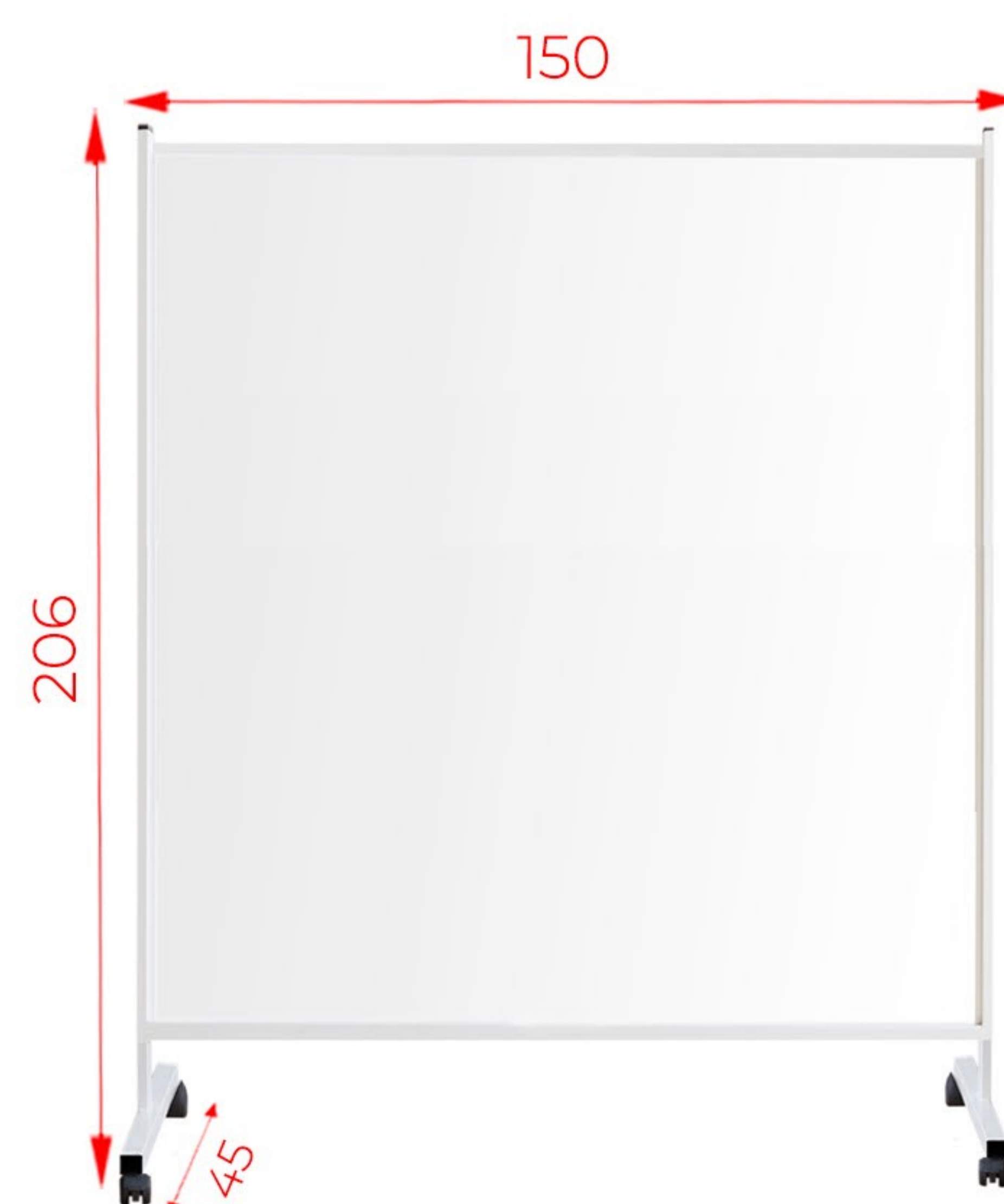



 EXPOSITOR DISPENSADOR DE GEL DESINFECTANTE ANTI VIRUS.

Artículo provisto de soporte de gel, bandeja con o sin tapa para guantes desechables, papelera con pedal de 12 litros de capacidad y soporte superior para bolsas. Estructura metálica resistente y estable pintada con pintura epoxi en color negro, blanco o plata.

Ideal para todo tipo de actividades Comerciales, oficinas, tiendas, empresas, supermercados, centros comerciales etc. (El expositor solamente incluye la papelera con pedal, no incluye ni los guantes ni el dosificador para geles desinfectantes)

 EXPOSANT DISTRIBUTEUR DE GEL DÉSINFECTANT ANTI VIRUS.

Cet article comprend un porte-gel, un plateau avec ou sans couvercle pour les gants jetables, une poubelle à pédale de 12 litres et un porte-sac supérieur. Structure métallique solide et stable peinte avec de la peinture époxy en noir, blanc ou argent.

Idéal pour toutes sortes d'activités commerciales, bureaux, magasins, entreprises, supermarchés, centres commerciaux, etc. (L'exposant n'inclut que le bac à pédales, n'inclut pas les gants ni le distributeur de gels désinfectants)

 ANTI-VIRUS DISINFECTANT GEL DISPENSER.

Article with gel support, tray with or without lid for disposable gloves, 12-litre pedal bin and top bag holder. Resistant and stable metal structure painted with black, white or silver epoxy paint.

Ideal for all kinds of commercial activities, offices, shops, companies, supermarkets, shopping centers. (The display only includes the pedal bin, does not include either gloves or the disinfectant gel dispenser)

 ANTIVIREN-DESINFEKTIONSGELSPENDER

Artikel mit Gelhalter, Tablett mit oder ohne Deckel für Einweghandschuhe, 12-Liter-Behälter mit Pedal und Oberbeutelhalter. Widerstandsfähige und stabile Metallstruktur mit schwarzer, weißer oder silberner Epoxidfarbe lackiert.

Ideal für alle Arten von kommerziellen Aktivitäten, Büros, Geschäften, Unternehmen, Supermärkten, Einkaufszentren usw. (Das Display enthält nur den Abfallbehälter mit Pedal. Es enthält weder Handschuhe noch den Desinfektionsgelspender)



REF. D1



REF. D2



REF. D3

	A	B	C	D	E	
Ref.: D1	130 cm	30 cm	30 cm	8,2 cm	8,2 cm	169,90 €
Ref.: D2	135 cm	30 cm	30 cm	8,2 cm	8,2 cm	169,90 €
Ref.: D3	135 cm	30 cm	30 cm	8,2 cm	8,2 cm	169,90 €

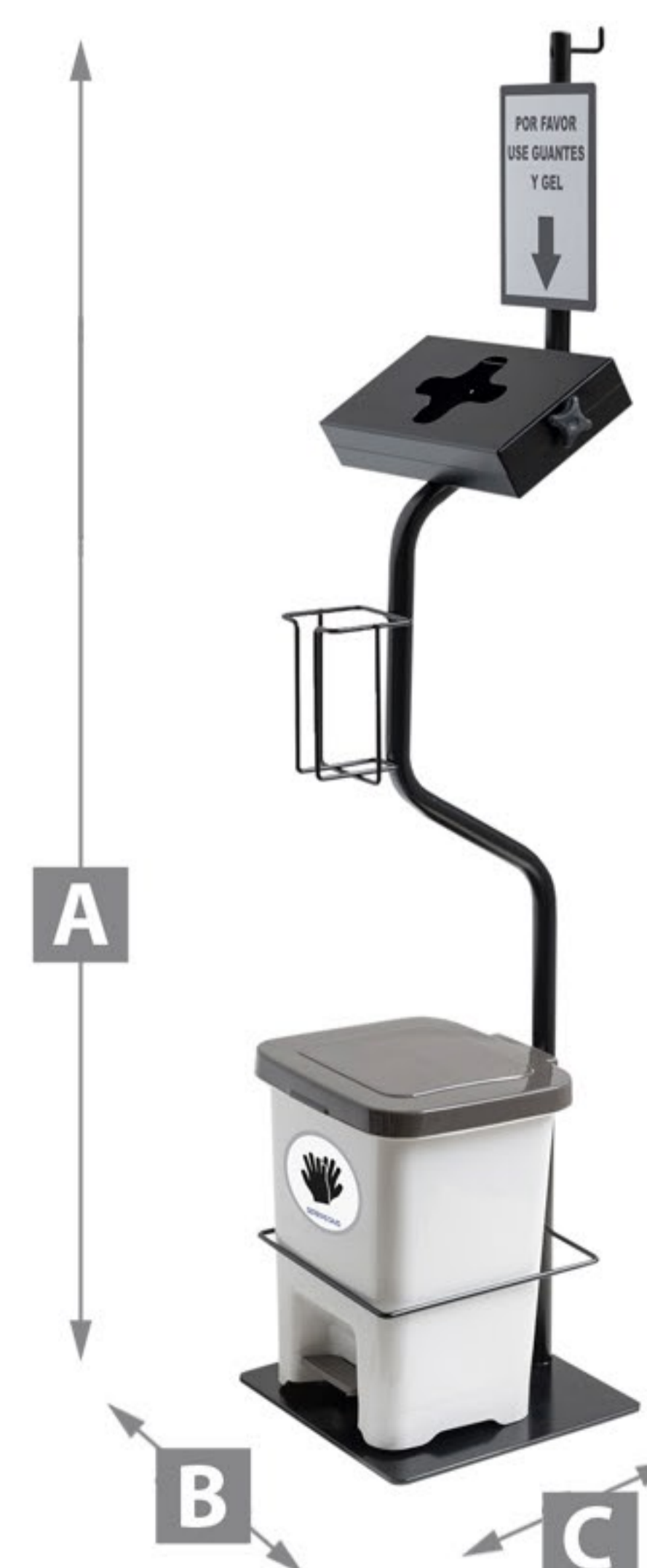

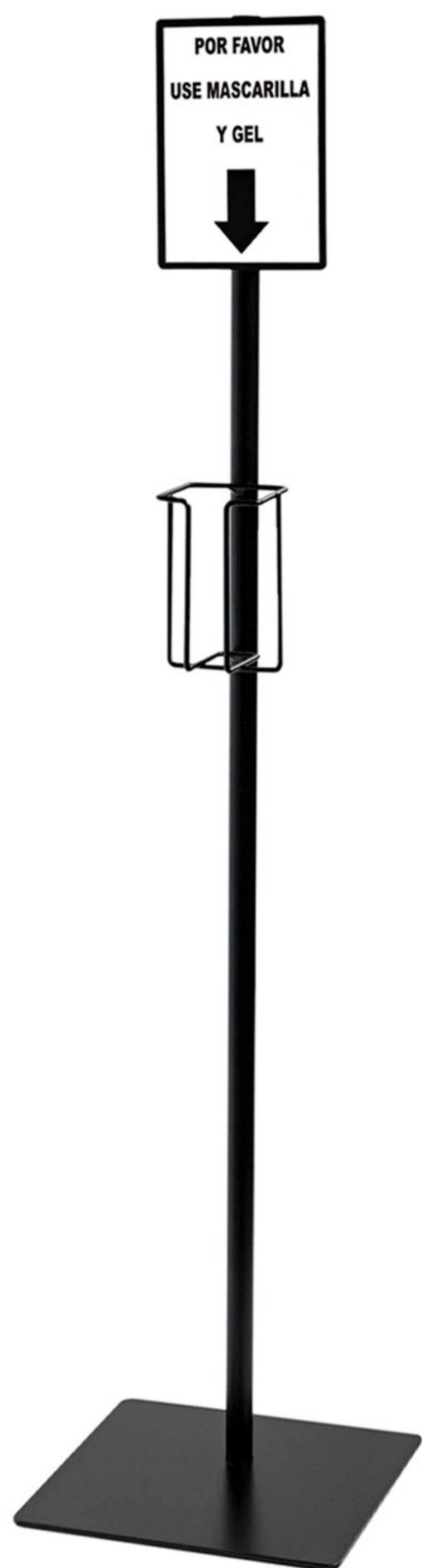

REF. D4

 EXPOSITOR DISPENSADOR DE GEL DESINFECTANTE ANTI VIRUS.

Artículo provisto de soporte de gel, bandeja con o sin tapa para guantes desechables, papelera con pedal de 12 litros de capacidad y soporte superior para bolsas. Estructura metálica resistente y estable pintada con pintura epoxi en color negro, blanco o plata.

Ideal para todo tipo de actividades Comerciales, oficinas, tiendas, empresas, supermercados, centros comerciales etc. (El expositor solamente incluye la papelera con pedal, no incluye ni los guantes ni el dosificador para geles desinfectantes)

 EXPOSANT DISTRIBUTEUR DE GEL DÉSINFECTANT ANTI VIRUS.

Cet article comprend un porte-gel, un plateau avec ou sans couvercle pour les gants jetables, une poubelle à pédale de 12 litres et un porte-sac supérieur. Structure métallique solide et stable peinte avec de la peinture époxy en noir, blanc ou argent.

Idéal pour toutes sortes d'activités commerciales, bureaux, magasins, entreprises, supermarchés, centres commerciaux, etc. (L'exposant n'inclut que le bac à pédales, n'inclut pas les gants ni le distributeur de gels désinfectants)

 ANTI-VIRUS DISINFECTANT GEL DISPENSER.

Article with gel support, tray with or without lid for disposable gloves, 12-litre pedal bin and top bag holder. Resistant and stable metal structure painted with black, white or silver epoxy paint.

Ideal for all kinds of commercial activities, offices, shops, companies, supermarkets, shopping centers. (The display only includes the pedal bin, does not include either gloves or the disinfectant gel dispenser)

 ANTIVIREN-DESINFEKTIONSGELSPENDER

Artikel mit Gelhalter, Tablett mit oder ohne Deckel für Einweghandschuhe, 12-Liter-Behälter mit Pedal und Oberbeutelhalter. Widerstandsfähige und stabile Metallstruktur mit schwarzer, weißer oder silberner Epoxidfarbe lackiert.

Ideal für alle Arten von kommerziellen Aktivitäten, Büros, Geschäften, Unternehmen, Supermärkten, Einkaufszentren usw. (Das Display enthält nur den Abfallbehälter mit Pedal. Es enthält weder Handschuhe noch den Desinfektionsgelspender)

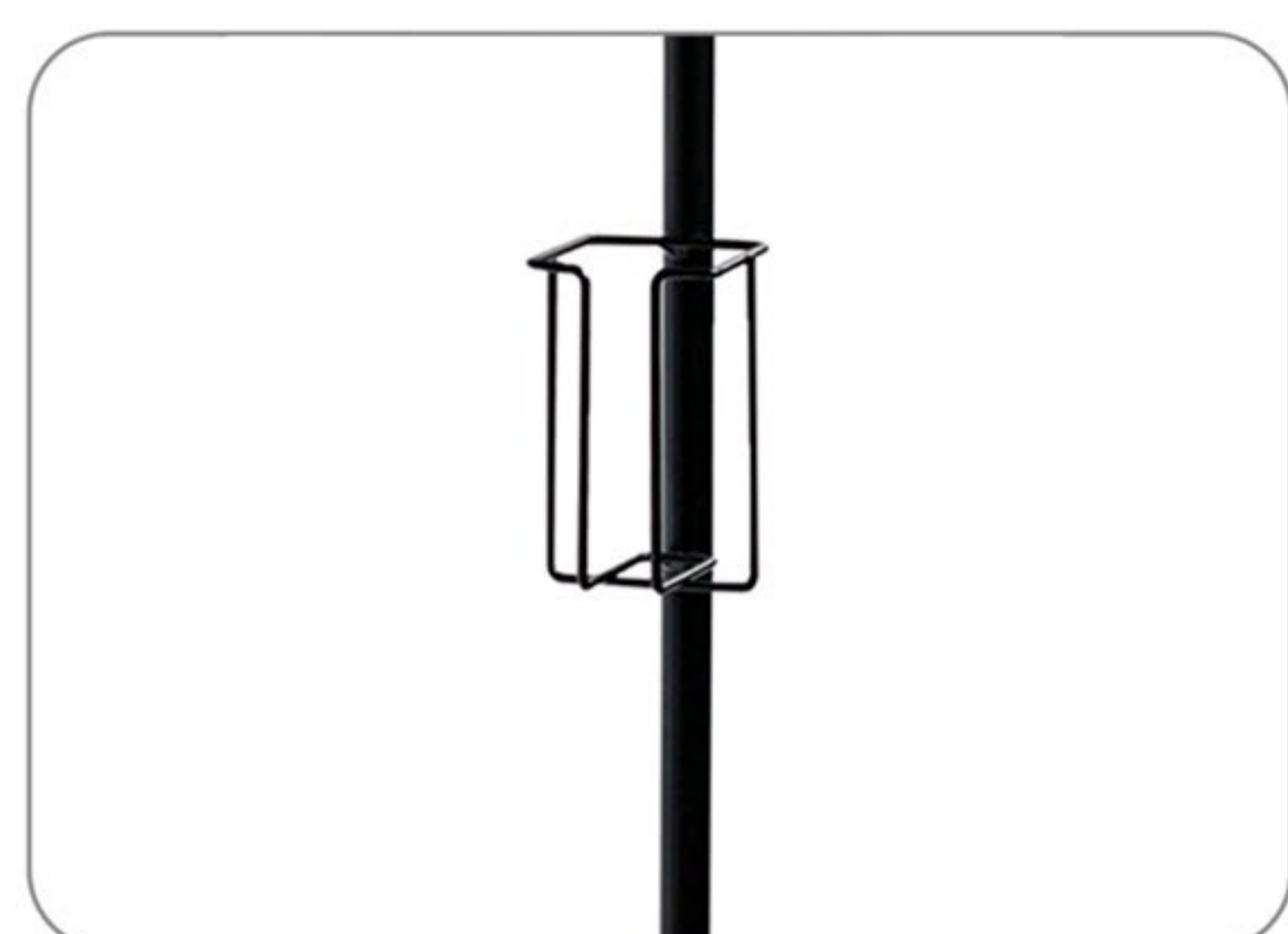

REF. D5

	A	B	C	D	E	
Ref.: D4	135 cm	30 cm	30 cm	8,2 cm	8,2 cm	94,00 €
Ref.: D5	135 cm	30 cm	30 cm	8,2 cm	8,2 cm	116,75 €

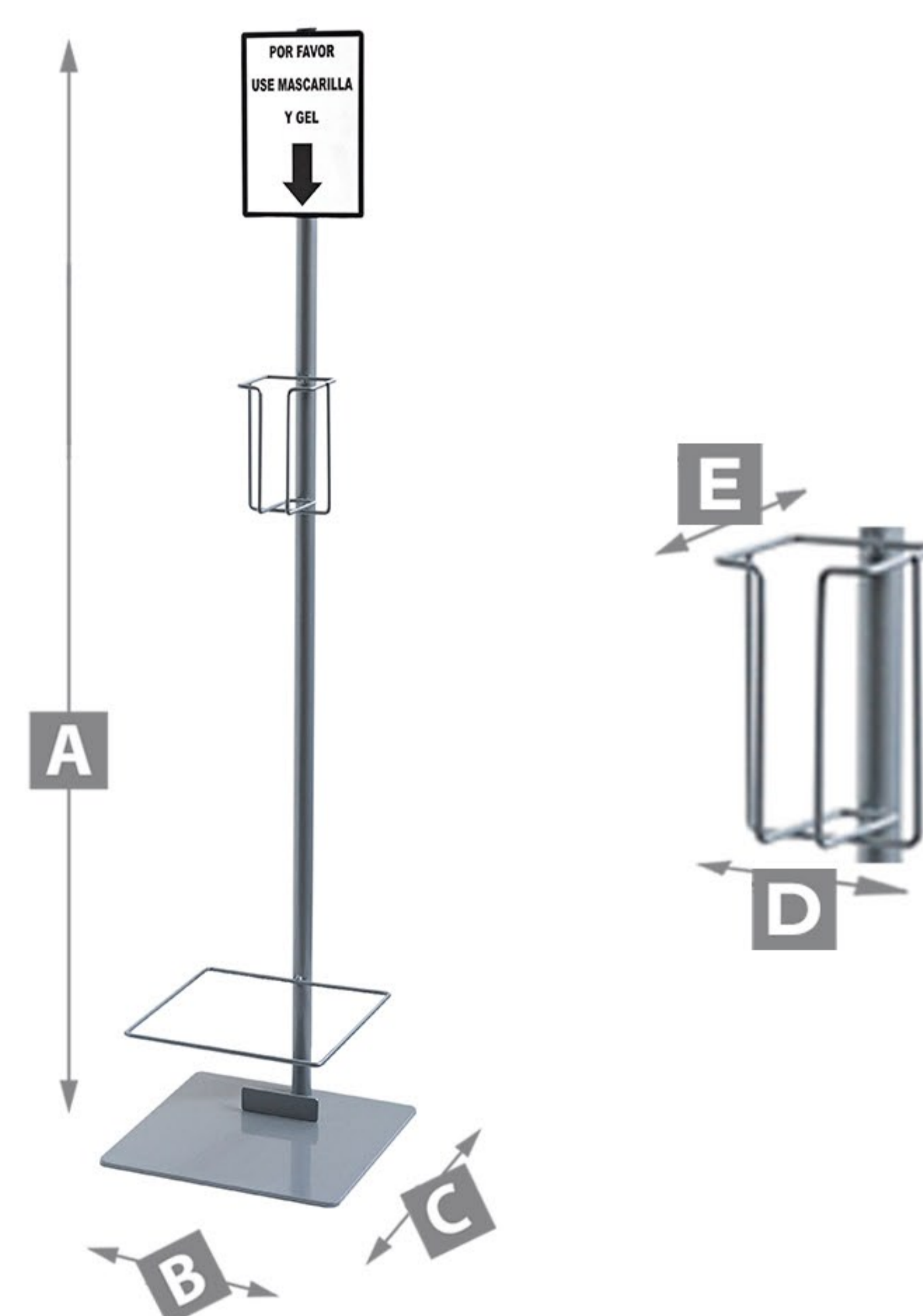



REF. D41



 EXPOSITOR DISPENSADOR DE GEL DESINFECTANTE ANTI VIRUS.

Estructura metálica resistente y estable pintada con pintura epoxi en color negro, blanco o plata. Ideal para todo tipo de actividades Comerciales, oficinas, tiendas, empresas, supermercados, centros comerciales etc.

Cubo de basura con pedal 12 Litros. Dispone de asas, para la fijación de la bolsa de basura. Incluye el dispensador automático ref. D10.

Estructura metálica pintada en color plata, negro o blanco.

 EXPOSANT DISTRIBUTEUR DE GEL DÉSINFECTANT ANTI VIRUS.

Structure métallique solide et stable peinte avec de la peinture époxy en noir, blanc ou argent. Idéal pour toutes sortes d'activités commerciales, bureaux, magasins, entreprises, supermarchés, centres commerciaux, etc.

Poubelle à pédale 12 Litres. Il a des poignées pour fixer le sac à poubelles.

Comprend un distributeur automatique réf. D10.

 ANTI-VIRUS DISINFECTANT GEL DISPENSER.

Resistant and stable metal structure painted with black, white or silver epoxy paint. Ideal for all kinds of commercial activities, offices, shops, companies, supermarkets, shopping centers.

Garbage container with pedal 12 Liters. It has handles, for fixing the garbage bag.

Includes automatic ref. D10 dispenser.

 ANTIVIREN-DESINFEKTIONSGELSPENDER

Widerstandsfähige und stabile Metallstruktur mit schwarzer, weißer oder silberner Epoxidfarbe lackiert. Ideal für alle Arten von kommerziellen Aktivitäten, Büros, Geschäften, Unternehmen, Supermärkten, Einkaufszentren usw.

Abfalleimer mit Pedal 12 Liters. Es hat Henkel für die Befestigung des Müllsacks.

Beinhaltet den automatischen Ref. D10 Spender.



REF. D51



	A	B	C	 Kg	
Ref.: D41	133 cm	33 cm	33 cm	8,00 Kg	129,00 €
Ref.: D51	133 cm	33 cm	33 cm	8,00 Kg	152,75 €

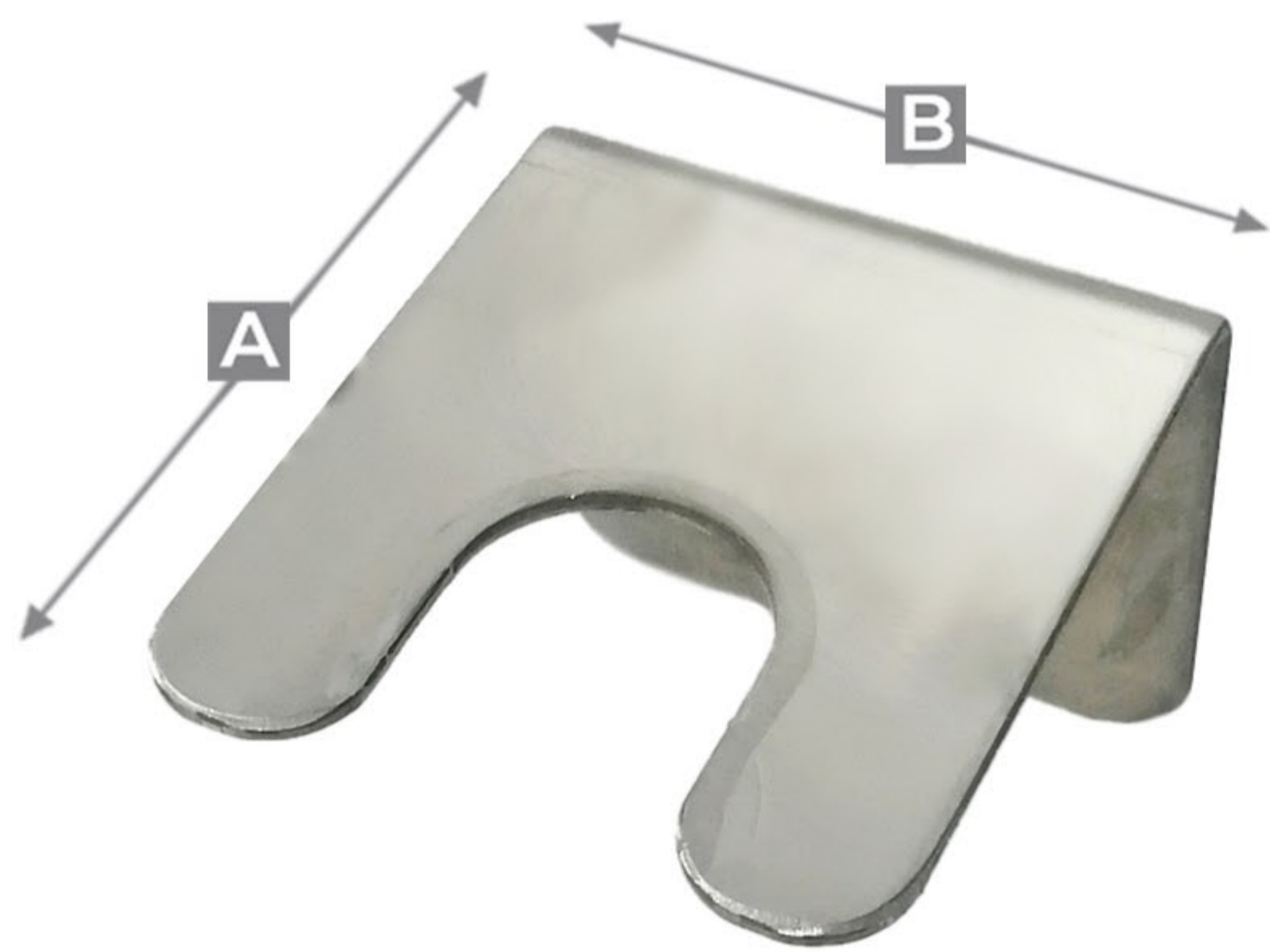

	A	B	C	€
Ref.: D11	6 cm	6 cm	7 cm	28,80 €

 **SOPORTE PARA DISPENSADOR.**

Soporte pared fabricado en acero inoxidable de 2 mm.
No se incluye el dosificador.

 **SUPPORT MURAL POUR DISTRIBUTEUR.**

Matériel: Acier inoxydable.
Le distributeur n'est pas inclus.

 **WALL SUPPORT FOR DISPENSER.**

Made of 2mm stainless steel.
Dispenser is not included.

 **WANDHÄLTER FÜR SPENDER.**

Werkstoff: Edelstahl.
Spender nicht beinhaltet.

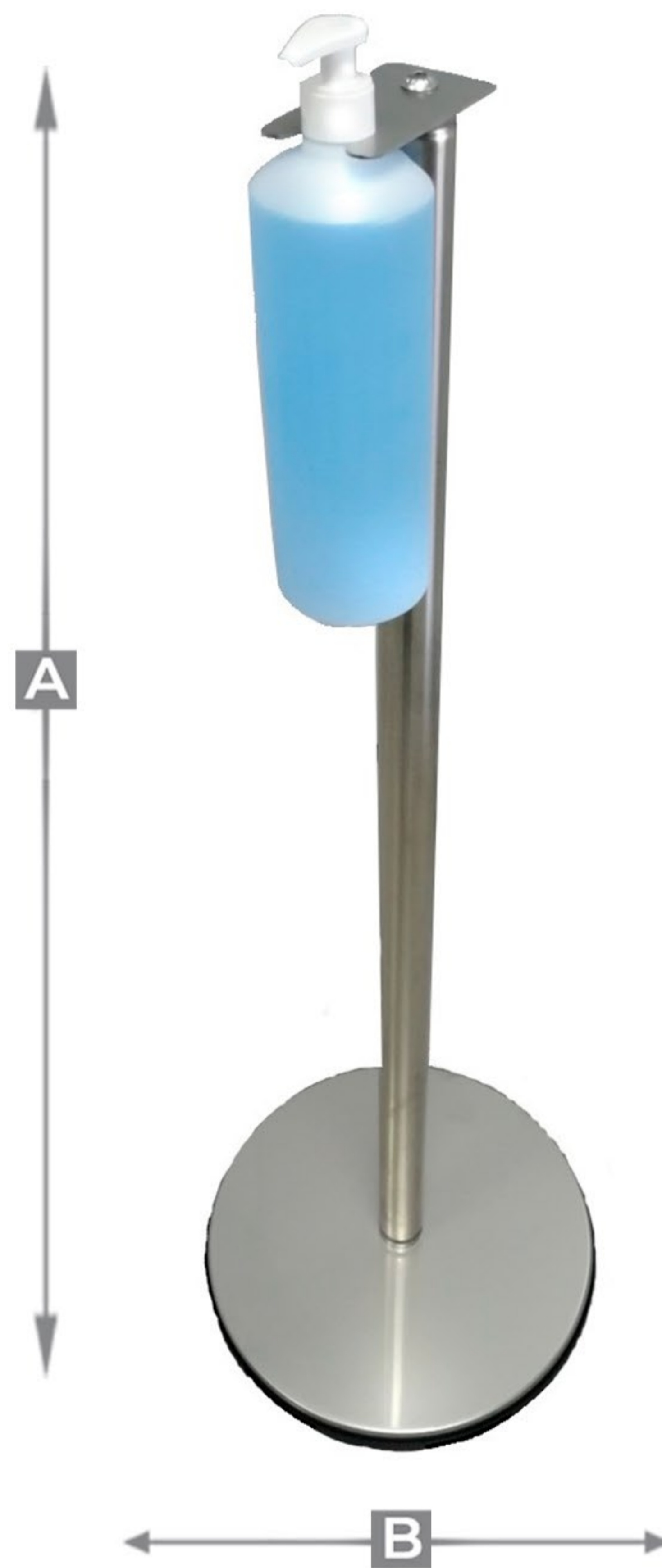

	A	B	C	€
Ref.: D6	103 cm	36cm	36 cm	129,00 €

 **SOPORTE DE PIE PARA DISPENSADOR DE GEL.**

Fabricado en acero inoxidable. Provisto de protector de goma en la base. No se incluye el dosificador.

 **SUPPORT SUR PIED POUR PLACER UN DISTRIBUTEUR DE DÉSINFECTION.**

Matériel: Acier inoxydable.
Le distributeur n'est pas inclus.

 **FLOOR SUPPORT FOR DESINFECTING DISPENSER.**

Article made of stainless steel.
Dispenser is not included.

 **BODENHÄLTER FÜR DESINFECTIERENDE SPENDER.**

Werkstoff: Edelstahl.
Spender nicht beinhaltet.



	A	B	€
Ref.: D7	130 cm	36 Ø	157,60 €
Ref.: D71	130 cm	36 Ø	234,30 €

ES SOPORTE DE PIE PARA DISPENSADOR AUTOMÁTICO DE GEL Y JABÓN DE MANOS.

Incluye bandeja para evitar el goteo, fabricada en acero inoxidable. Provisto de protector de goma en la base.

No incluye el dispensador de gel (Ref. D7).
Incluye el dispensador automático gel y jabón de manos (Ref. D71).

Puede incluir el dispensador de la imagen o otro tipo de dispensador automático.

FR SUPPORT SUR PIED POUR DISTRIBUTEUR AUTOMATIQUE DE GEL ET DE SAVON POUR LES MAINS.

Comprend un plateau pour éviter les gouttes.
Matériel: Acier inoxydable.

Le distributeur n'est pas inclus (Ref.D7).
Comprend le distributeur automatique de gel et de savon pour les mains (Ref.D71).

Il peut inclure le distributeur vu dans l'image ou un autre type de distributeur automatique.

UK FLOOR SUPPORT FOR AUTOMATIC HAND GEL AND SOAP DISPENSER.

Includes tray for avoiding dripping. Article made of stainless steel.

Dispenser is not included (Ref. D7).
Automatic hand gel and soap dispenser is included (Ref.D71)

It may include the dispenser in the image or another type of automatic dispenser

DE BODENHÄLTER FÜR AUTOMATISCHER HAND GEL UND SEIFE SPENDER.

Beinhaltet Tablett um das Tröpfeln zu vermeiden.
Werkstoff: Edelstahl.

Spender nicht beinhaltet (Ref. D7).
Automatischer Hand Gel und Seife Spender beinhaltet (Ref. D71).

Es kann den Spender des Bildes oder einen anderen automatischen Spender enthalten.





 SOPORTE DE PIE PARA DISPENSADOR AUTOMÁTICO DE GEL Y JABÓN DE MANOS.

Incluye bandeja para evitar el goteo. Estructura pintada en color negro. Imprescindible fijar el soporte al suelo para el uso de dosificadores manuales.

No incluye el dispensador de gel (Ref. D8). Incluye el dispensador automático gel y jabón de manos (Ref. D81).

Puede incluir el dispensador de la imagen o otro tipo de dispensador automático.

 SUPPORT SUR PIED POUR DISTRIBUTEUR AUTOMATIQUE DE GEL ET DE SAVON POUR LES MAINS.

Comprend un plateau pour éviter les gouttes. Il est indispensable de fixer le support au sol pour l'utilisation de distributeurs manuels.

Le distributeur n'est pas inclus (Ref.D8). Comprend le distributeur automatique de gel et de savon pour les mains (Ref.D81).

Il peut inclure le distributeur vu dans l'image ou un autre type de distributeur automatique.

 FLOOR SUPPORT FOR AUTOMATIC HAND GEL AND SOAP DISPENSER.

Includes tray for avoiding dripping. Absolutely necessary to fix the support to the floor for the use of manual dispensers.

Dispenser is not included (Ref. D8). Automatic hand gel and soap dispenser is included (Ref.D81)

It may include the dispenser in the image or another type of automatic dispenser.

 BODENHÄLTER FÜR AUTOMATISCHER HAND GEL UND SEIFE SPENDER.

Beinhaltet Tablett um das Tröpfeln zu vermeiden. Absolut notwendig den Halter auf den Boden zu montieren für den Gebrauch von manuellen Spender.

Spender nicht beinhaltet (Ref. D8). Automatischer Hand Gel und Seife Spender beinhaltet (Ref. D81).

Es kann den Spender des Bildes oder einen anderen automatischen Spender enthalten.

	A	B	C	€
Ref.: D8	125 cm	33 cm	33 cm	168,90 €
Ref.: D81	125 cm	33 cm	33 cm	247,50 €

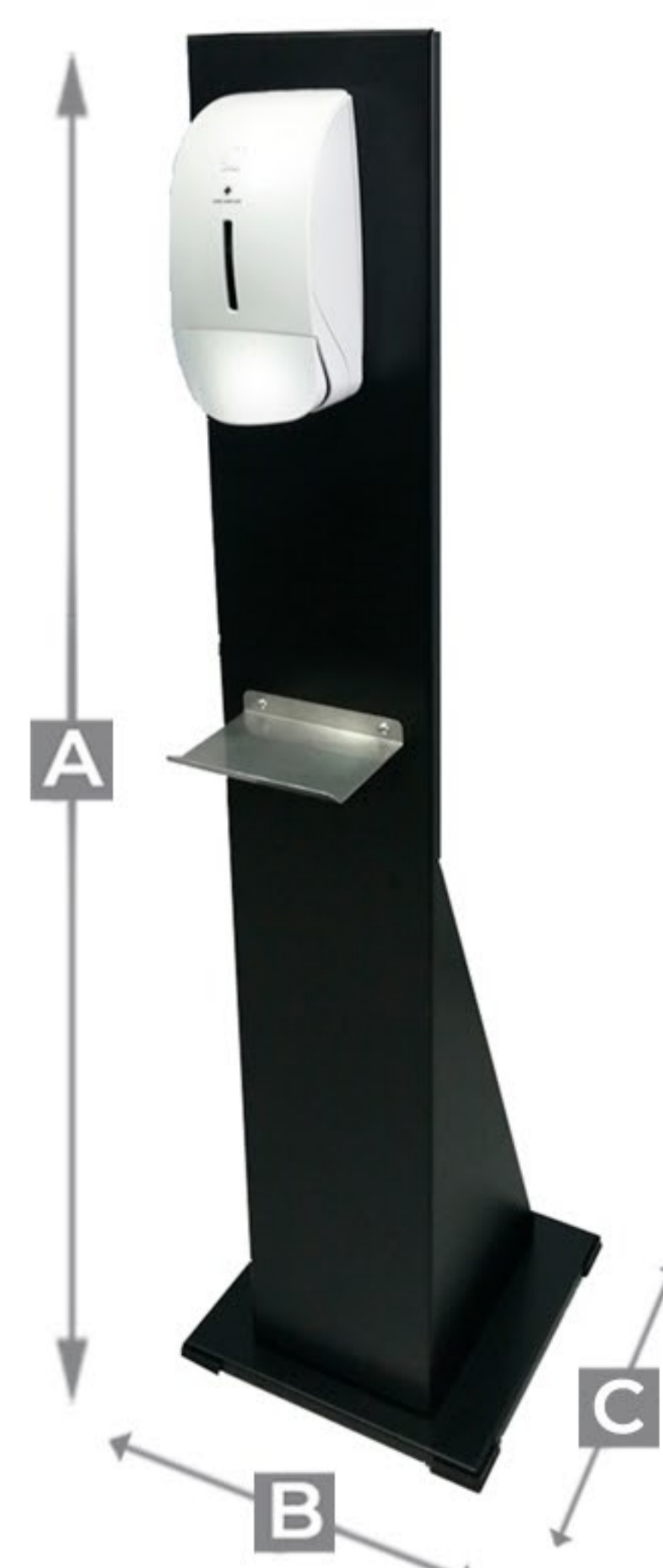



 **SOPORTE DE PIE CON PEDAL PARA DISPENSADOR DE GEL**

Mecanismo de pedal en acero inoxidable. Con regulador de dosis. Estructura pintada en color negro. No se incluye el dosificador

 **SUPPORT SUR PIED À PÉDALE**

Mécanisme du pédale en acier inoxydable. Avec régulateur de dose. Le distributeur n'est pas inclus.

 **FLOOR SUPPORT WITH PEDAL.**

Stainless steel pedal mechanism. With dose regulator. Dispenser is not included.

 **BODENHÄLTER MIT PEDAL**

Rostfreier stahl pedal mechanismus. Mit Dosenregulierer. Spender nicht beinhaltet.



	A	B	C	€
Ref.: D9	125 cm	33 cm	33 cm	386,60 €

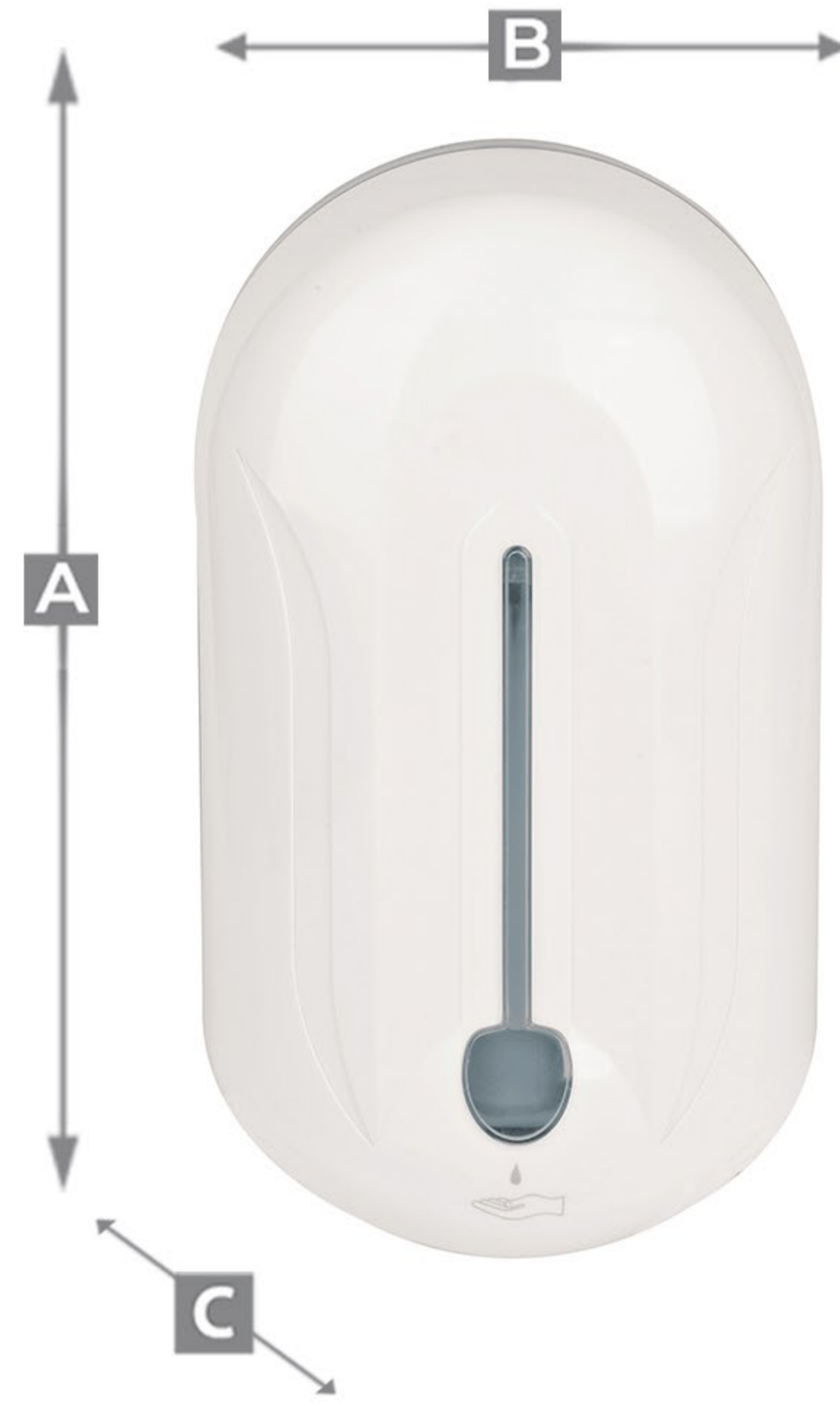

	A	B	C		
Ref.: D10	23,5 cm	14 cm	10,7 cm	0,900 Kg	45,25€

DISPENSADOR AUTOMÁTICO GEL

Dispensador Automático Gel y Jabón de Manos, sin contacto, funcionamiento por Sensor Infrarrojos Automático.

- Con válvula anti-goteo.
- Visor de llenado.
- Material: ABS.
- Capacidad: 1,1 litros.
- Dispensa: Jabón líquido / Gel hidroalcohólico.
- Rellenable por la parte superior.
- Funcionamiento automático con 4 pilas C-LR14.
- Dosis por pulsación: 1 ml.

DISTRIBUTEUR AUTOMATIQUE DE GEL

Distributeur automatique de gel et de savon pour les mains, sans contact, fonctionnement par capteur infrarouge automatique.

- Avec valve anti-goutte.
- Viseur de remplissage
- Matériel: ABS.
- Capacité: 1,1 litre.
- Dispenses: Savon liquide / Gel hydroalcoolique.
- Rechargeable en haut.
- Fonctionnement automatique avec 4 piles C-LR14.
- Dose par impulsion: 1 ml.

AUTOMATIC HAND GEL DISPENSER.

Automatic hand gel and soap dispenser, without contact, function through Automatic Infrared Sensor.

- With anti-trickle valve.
- Fill display.
- Material: ABS.
- Capacity: 1.1 litres.
- Dispenses: Liquid soap/ hydro alcoholic gel.
- Refillable through the top part.
- Automatic functioning with 4 C-LR14 batteries.
- Dose through pulsing: 1ml.

AUTOMATISCHER HAND GEL SPENDER

Automatischer Hand Gel und Seife Spender, ohne Kontakt, Funktion durch automatischen Infrarot Sensor.

- Mit anti-tröpfeln Klappe.
- Display mit Inhaltsangabe.
- Material: ABS.
- Kapazität: 1.1 Liter.
- Spendet: Flüssige Seife/ hydro-alkoholisches Gel.
- Nachfüllbar durch den oberen Teil.
- Automatisches Funktionieren mit 4 C-LR14 Batterien.
- Dosierung durch Anschlag: 1ml.



	A	B	C		
Ref.: D12	220 mm	100 mm	110 mm	1,10 Kg	85 €

DISPENSADOR AUTOMÁTICO GEL

Dispensador Automático Gel y Jabón de Manos, sin contacto, funcionamiento por Sensor Infrarrojos Automático.

- Visor de llenado.
- Material: Acero inoxidable Satinado.
- Capacidad: 0,70 litros.
- Dispensa: Jabón líquido / Gel hidroalcohólico.
- Sistema de bloqueo para impedir el robo y mantener la integridad del contenido.
- Funcionamiento automático con 4 pilas C-LR14.
- Dosis por pulsación: 0,5 – 2,5 ml.
- Indicador led para baja batería

DISTRIBUTEUR AUTOMATIQUE DE GEL

Distributeur automatique de gel et de savon pour les mains, sans contact, fonctionnement par capteur infrarouge automatique.

- Viseur de remplissage
- Matériel: Acier inoxydable satiné.
- Capacité: 0,7 litre.
- Dispenses: Savon liquide / Gel hydroalcoolique.
- Système de verrouillage pour empêcher le vol et maintenir l'intégrité du contenu.
- Fonctionnement automatique avec 4 piles C-LR14.
- Dose par impulsion: 0,5 – 2,5 ml.
- Indicateur LED de batterie faible.

AUTOMATIC HAND GEL DISPENSER.

Automatic hand gel and soap dispenser, without contact, function through Automatic Infrared Sensor.

- Fill display.
- Material: Glossy stainless Steel.
- Capacity: 0.7 litres.
- Dispenses: Liquid soap/ hydro alcoholic gel.
- Blockage system to avoid robberies and maintain the integrity of the content.
- Automatic functioning with 4 C-LR14 batteries.
- Dose through pulsing: 0,5 – 2,5ml.
- Led indicator for low battery.

AUTOMATISCHER HAND GEL SPENDER

Automatischer Hand Gel und Seife Spender, ohne Kontakt, Funktion durch automatischen Infrarot Sensor.

- Display mit Inhaltsangabe.
- Werkstoff: Satiniertes rostfreies Stahl.
- Kapazität: 0.7 Liter.
- Spendet: Flüssige Seife/ hydro-alkoholisches Gel.
- Blockierungssystem um Diebstähle zu vermeiden und die Integrität des Inhalts zu behalten.
- Automatisches Funktionieren mit 4 C-LR14 Batterien.
- Dosierung durch Anschlag: 0,5 – 2,5ml.
- Led-Anzeiger für niedriger Batteriestatus.



Ref.: D14 **A** 210 mm **B** 140 mm **C** 95 mm **Kg** 0,900 Kg **€** 88€

DISPENSADOR AUTOMÁTICO GEL

Dispensador Automático Gel y Jabón de Manos, sin contacto, funcionamiento por Sensor Infrarrojos Automático.

- Con válvula anti-goteo.
- Visor de llenado.
- Material: Acero inoxidable Brillo.
- Capacidad: 1,2 litros.
- Dispensa: Jabón líquido / Gel hidroalcohólico.
- Sistema de bloqueo para impedir el robo y mantener la integridad del contenido.
- Funcionamiento automático con 4 pilas C-LR14.
- Dosis por pulsación: 1 ml.
- Indicador led para baja batería.

AUTOMATIC HAND GEL DISPENSER.

Automatic hand gel and soap dispenser, without contact, function through Automatic Infrared Sensor.

- With anti-trickle valve.
- Fill display.
- Material: Shining Stainless Steel.
- Capacity: 1.2 litres.
- Dispenses: Liquid soap/ hydro alcoholic gel.
- Blockage system to avoid robberies and maintain the integrity of the content.
- Automatic functioning with 4 C-LR14 batteries.
- Dose through pulsing: 1ml.
- Led indicator for low battery.

DISTRIBUTEUR AUTOMATIQUE DE GEL

Distributeur automatique de gel et de savon pour les mains, sans contact, fonctionnement par capteur infrarouge automatique.

- Avec valve anti-goutte.
- Viseur de remplissage
- Matériel: acier inoxydable brillant.
- Capacité: 1,2 litre.
- Dispenses: Savon liquide / Gel hydroalcoolique.
- Système de verrouillage pour empêcher le vol et maintenir l'intégrité du contenu.
- Fonctionnement automatique avec 4 piles C-LR14.
- Dose par impulsion: 1 ml.
- Indicateur LED de batterie faible.

AUTOMATISCHER HAND GEL SPENDER

Automatischer Hand Gel und Seife Spender, ohne Kontakt, Funktion durch automatischen Infrarot Sensor.

- Mit anti-tröpfeln Klappe.
- Display mit Inhaltsangabe.
- Werkstoff: Helligkeit rostfreies Stahl.
- Kapazität: 1.2 Liter.
- Spendet: Flüssige Seife/ hydro-alkoholisches Gel.
- Blockierungssystem um Diebstähle zu vermeiden und die Integrität des Inhalts zu behalten.
- Automatisches Funktionieren mit 4 C-LR14 Batterien.
- Dosierung durch Anschlag: 1ml.
- Led-Anzeiger für niedriger Batteriestatus.



Ref.: D15

A	B	C	Kg	€
210 mm	140 mm	95 mm	0,900 Kg	85€

 **DISPENSADOR AUTOMÁTICO GEL**

Dispensador Automático Gel y Jabón de Manos, sin contacto, funcionamiento por Sensor Infrarrojos Automático.

- Con válvula anti-goteo.
- Visor de llenado.
- Material: Acero inoxidable Satinado.
- Capacidad: 1,2 litros.
- Dispensa: Jabón líquido / Gel hidroalcohólico.
- Sistema de bloqueo para impedir el robo y mantener la integridad del contenido.
- Funcionamiento automático con 4 pilas C-LR14.
- Dosis por pulsación: 1 ml.
- Indicador led para baja batería.

 **DISTRIBUTEUR AUTOMATIQUE DE GEL**

Distributeur automatique de gel et de savon pour les mains, sans contact, fonctionnement par capteur infrarouge automatique.

- Avec valve anti-goutte.
- Viseur de remplissage
- Matériel: Acier inoxydable satiné.
- Capacité: 1,2 litre.
- Dispenses: Savon liquide / Gel hydroalcoolique.
- Système de verrouillage pour empêcher le vol et maintenir l'intégrité du contenu.
- Fonctionnement automatique avec 4 piles C-LR14.
- Dose par impulsion: 1 ml.
- Indicateur LED de batterie faible.

 **AUTOMATIC HAND GEL DISPENSER.**

Automatic hand gel and soap dispenser, without contact, function through Automatic Infrared Sensor.

- With anti-trickle valve.
- Fill display.
- Material: Glossy stainless Steel.
- Capacity: 1.2 litres.
- Dispenses: Liquid soap/ hydro alcoholic gel.
- Blockage system to avoid robberies and maintain the integrity of the content.
- Automatic functioning with 4 C-LR14 batteries.
- Dose through pulsing: 1ml.
- Led indicator for low battery.

 **AUTOMATISCHER HAND GEL SPENDER**

Automatischer Hand Gel und Seife Spender, ohne Kontakt, Funktion durch automatischen Infrarot Sensor.

- Mit anti-tröpfeln Klappe.
- Display mit Inhaltsangabe.
- Werkstoff: Satiniertes rsotfreies Stahl.
- Kapazität: 1.2 Liter.
- Spendet: Flüssige Seife/ hydro-alkoholisches Gel.
- Blockierungssystem um Diebstähle zu vermeiden und die Integrität des Inhalts zu behalten.
- Automatisches Funktionieren mit 4 C-LR14 Batterien.
- Dosierung durch Anschlag: 1ml.
- Led-Anzeiger für niedriger Batteriestatus.



	A	B	C		
Ref.: D16	200 mm	100 mm	110 mm	0,100 Kg	18€

DISPENSADOR DE GEL

- Con válvula anti-goteo.
- Visor de llenado.
- Material: ABS Blanco / Gris
- Capacidad: 0,8 litros.
- Dispensa: Jabón líquido / Gel hidroalcohólico.
- Sistema de bloqueo para impedir el robo y mantener la integridad del contenido.

DISTRIBUTEUR DE GEL

- Avec valve anti-goutte.
- Viseur de remplissage
- Matériel: ABS blanc / gris
- Capacité: 0,8 litre.
- Dispenses: Savon liquide / Gel hydroalcoolique.
- Système de verrouillage pour empêcher le vol et maintenir l'intégrité du contenu.

HAND GEL DISPENSER

- With anti-trickle valve.
- Fill display.
- Material: ABS White / Gray
- Capacity: 0.8 litres.
- Dispenses: Liquid soap/ hydro alcoholic gel.
- Blockage system to avoid robberies and maintain the integrity of the content.

HAND GEL SPENDER

- Mit anti-tröpfeln Klappe.
- Display mit Inhaltsangabe.
- Werkstoff: ABS Weiß / Grau
- Kapazität: 0.8 Liter.
- Spendet: Flüssige Seife/ hydro-alkoholisches Gel.
- Blockierungssystem um Diebstähle zu vermeiden und die Integrität des Inhalts zu behalten.



	A	B	C		
Ref.: D17	210 mm	128 mm	90 mm	0,338 Kg	18€

DISPENSADOR DE GEL

- Con válvula anti-goteo.
- Visor de llenado.
- Material: ABS Blanco
- Capacidad: 0,9 litros.
- Dispensa: Jabón líquido / Gel hidroalcohólico.
- Sistema de bloqueo para impedir el robo y mantener la integridad del contenido.

DISTRIBUTEUR DE GEL

- Avec valve anti-goutte.
- Viseur de remplissage
- Matériel: ABS blanc
- Capacité: 0,9 litre.
- Dispenses: Savon liquide / Gel hydroalcoolique.
- Système de verrouillage pour empêcher le vol et maintenir l'intégrité du contenu.

HAND GEL DISPENSER.

- With anti-trickle valve.
- Fill display.
- Material: ABS White
- Capacity: 0.9 litres.
- Dispenses: Liquid soap/ hydro alcoholic gel.
- Blockage system to avoid robberies and maintain the integrity of the content.

HAND GEL SPENDER

- Mit anti-tröpfeln Klappe.
- Display mit Inhaltsangabe.
- Werkstoff: ABS Weiß
- Kapazität: 0.9 Liter.
- Spendet: Flüssige Seife/ hydro-alkoholisches Gel.
- Blockierungssystem um Diebstähle zu vermeiden und die Integrität des Inhalts zu behalten.

 MASCARILLA HIGIÉNICA REUTILIZABLE Y LAVABLE

Mascarilla higiénica con doble capa para una mayor protección. Capa exterior confeccionada con tejido hidrofugado que actúa como barrera del agua y las microgotas.

Eficacia de protección contra partículas de 3µm superior al 91%.
 Alta respirabilidad y eficiencia respiratoria de 745 L·m⁻²·s⁻¹.
 Las gomas laterales facilitan una buena adaptación a la cara.
 Reutilizable y lavable a 60°.
 Tallajes de adulto y niño.
 Homologación certificada por la DGA con resultado en Categoría 1 (UNS 1), equivalente UNE 0065:2020.

Modelos de mascarillas:
 Mascarilla sin impresión: Ref. M1
 Mascarilla impresión Logo a color: Ref. M2
 Mascarilla personalizada: Ref. M3 Mascarilla personalizada con cualquier tipo de diseño, logotipos, frases, colores, imágenes etc...)

Este producto no debe considerarse producto sanitario, ni equipo de protección (EPI).

 HYGIENIC, WASHABLE AND REUSABLE MASKS

Hygienic mask with a double layer for greater protection. Outer layer manufactured with damp-proof cloth that acts as a barrier for the water and the micro-drops.

Protection efficiency against 3µm particles superior to 91%.
 High breathability and respiratory efficiency of 745l m²·s⁻¹.
 The side elastics provide a good adaptation to the face.
 Reusable and washable at 60°.
 Sizes for adults and children.
 Certified standardization by the General Water Management with result in Category 1 (UNS 1) equivalent to UNE 0065:2020.

Mask models:
 Masks without printing. Ref. M1
 Mask with printing. Logo in color. Ref. M2
 Personalized mask. Ref. M3 Personalized masks with any type of design (logos, phrases, colors, images, etc...)

This product should be considered neither as sanitary nor as protective equipment (EPI).

 MASQUES HYGIÉNIQUES RÉUTILISABLES ET LAVABLES

Masque hygiénique à double couche pour une meilleure protection. Couche extérieure en tissu imperméable qui agit comme barrière contre l'eau et les micro gouttelettes.

Efficacité de protection contre les particules de 3 µm supérieure à 91%.
 Haute respirabilité et efficacité respiratoire de 745 L · m⁻² · s⁻¹.
 Les élastiques latéraux facilitent une bonne adaptation au visage.
 Réutilisable et lavable à 60 °.
 Tailles adultes et enfants.
 Conforme aux spécifications DGA avec résultat en catégorie 1 (UNS 1), équivalent UNE 0065: 2020.

Modèles de masques:
 Masque sans impression. Ref. M1
 Masque imprimé logo couleur. Ref. M2
 Masque personnalisée Ref. M3 Masque personnalisé avec tout type de design (logos, phrases, couleurs, images etc ...)

Ce produit ne doit pas être considéré comme un dispositif médical ou un équipement de protection (EPI).

 HYGENISCHE, WASCHBARE UND WIEDERBRAUCHBARE MASKEN

Hygienische Mask mit einer doppelten Schicht für mehr Schutz. Äussere Schicht hergestellt mit wassermeidendem Stoff der als Barriere gegen das Wasser und die Mikro-Tropfen wirkt.

Schutzeffizienz gegen 3µm Partikel höher als 91%.
 Hohe Atmungsaktivität und Atmungseffizienz von 745l m²·s⁻¹.
 Die seitlichen Gummibänder bieten eine gute Gesichtsanpassung an.
 Wiederbrauchbar und waschbar bei 60°.
 Größen für Erwachsene und Kinder.
 Bescheinigte Anerkennung durch die Generelle Wasser Direktion mit Resultat in der Kategorie 1 (UNS 1) gleichwertig zu UNE 0065:2020.

Maskenmodelle:
 Masken ohne Bedruckung. Ref. M1
 Maske mit Bedruckung. Farbiges Logo. Ref. M2
 Personalisierte Maske. Ref. M3 Personalisierte Maske mit jeglichem Designtyp (Logos, Texte, Farben, Abbildungen, usw.....)

Dieses Produkt sollte nicht als sanitäres noch als Schutzausstattung betrachtet werden.



REF. M1

MASCARILLA SIN IMPRESIÓN | MASQUE SANS IMPRESSION | MASKS WITHOUT PRINTING | MASKEN OHNE BEDRUCKUNG.



REF. M2

MASCARILLA IMPRESIÓN LOGO A COLOR | MASQUE IMPRIMÉ LOGO COULEUR | MASK WITH PRINTING. LOGO IN COLOR |
 MASKE MIT BEDRUCKUNG. FARBIGES LOGO.



REF. M3

MASCARILLA PERSONALIZADA | MASQUE PERSONNALISÉE | PERSONALIZED MASK | PERSONALISIERTE MASKE



Ref. : M1

12 gr.

2,60 €

Ref. : M2

12 gr.

3,85 €

Ref. : M3

12 gr.

5,26€

 MASCARILLA HIGIÉNICA REUTILIZABLE Y LAVABLE

La mascarilla higiénica reutilizable está confeccionada con 3 capas de 100% poliéster de 240gr/m². Tienen dos gomas elásticas con sujeción a las orejas para mayor comodidad. Fabricadas en tejido compactado de tres capas.

Este producto no debe considerarse producto sanitario, ni equipo de protección (EPI). Eficiencia de la filtración bacteriana (BFE): Después de 10 Lavados 75% (Certificado).

RESPIRABILIDAD: PRESIÓN DIFERENCIAL: ≤ 60

Material certificado OEKO-TEX®

Se venden en packs de 5 unidades (Precio por unidad)

Medidas: 16cm. (Alto) x 20 cm. (Ancho)

Colores: Negra, Azul, Granate, Negra/Blanca



 MASQUES HYGIÉNIQUES RÉUTILISABLES ET LAVABLES

Le masque hygiénique réutilisable est composé de 3 couches de 100% polyester de 240gr / m². Ils ont deux bandes élastiques avec fixation aux oreilles pour être plus confortables. Fabriqué en tissu compact à trois couches.

Ce produit ne doit pas être considéré comme un dispositif médical ou un équipement de protection (EPI). Efficacité de filtration bactérienne (BFE): après 10 lavages à 75% (certifié).

RESPIRABILITÉ: PRESSION DIFFÉRENTIELLE: ≤ 60

Matériel certifié OEKO-TEX®

Vendu en paquets de 5 unités (Prix unitaire).

Couleurs: noir, bleu, grenat, noir / blanc.



 HYGIENIC, WASHABLE AND REUSABLE MASKS

The reusable hygienic mask is made of 3 layers of 100% polyester of 240g/ m². It has two elastics in order to fasten over the ears for more comfort. Made of three-layer compact fabric.

This product should be considered neither as sanitary nor as protective equipment (EPI). Bacterial Filtration Efficiency (BFE): After 10 washings 75% (certified).

BREATHABILITY: DIFFERENTIAL PRESSURE: ≤ 60

OEKO-TEX certified material®

Sold in packs of 5 units (Price per unit).



 HYGENISCHE, WASCHBARE UND WIEDERBRAUCHBARE MASKEN

Die wiederverwendbare Hygienemaske besteht aus 3 Lagen 100% Polyester von 240g/m². Sie hat zwei elastische Gummis mit Ohrbefestigung für besseren Komfort. Hergestellt aus dreilagigem Kompaktgewebe.

Dieses Produkt sollte nicht als sanitäres noch als Schutzausstattung betrachtet werden. Bakterielle Filtrationseffizienz (BFE): Nach 10 Mal waschen 75% (bescheinigt).

ATMUNGSAKTIVITÄT: DIFFERENZDRUCK: ≤ 60

Bescheinigtes OEKO-TEX® Material

Wird verkauft in Packungen mit 5 Stück (Preis pro Einheit).



16 cm x 20 cm

Ref.: M4

 12 gr.

 **2,97 €**

🇪🇸 MASCARILLA HIGIÉNICA REUTILIZABLE Y LAVABLE

La mascarilla higiénica reutilizable está confeccionada con 2 capas de 100% poliéster de 86gr/m². Tienen dos gomas elásticas con sujeción a las orejas para mayor comodidad. Material certificado OEKO-TEX®

Tejido Hidrofugado doble capa.
 Tratamiento Antibacteriano.
 Capa interna blanca homologada.
 Resistente a la penetración microbiana : Blood Barrier.

Durabilidad de los tratamientos : 25 Lavados a 60 grados.
 Norma: UNE0065/20
 Respirabilidad (PA/cm²) < 60
 Filtración +95%

TALLAS:
 Niño 6-9 años: 6.5 x 15 cm aprox. (bajo pedido)
 Niño 9-12 años: 8.5 x 17 cm aprox.
 Adulto: 12 x 18 cm aprox.

Personalización a partir de 50 unidades (Precio por unidad).
 Este producto no debe considerarse producto sanitario, ni equipo de protección (EPI).

🇫🇷 MASQUES HYGIÉNIQUES RÉUTILISABLES ET LAVABLES

Le masque hygiénique réutilisable est composé de 2 couches de 100% polyester de 86gr / m². Ils ont deux bandes élastiques avec fixation aux oreilles pour être plus confortables. Matériel certifié OEKO-TEX®

RESPIRABILITÉ: PRESSION DIFFÉRENTIELLE: ≤ 60
 Normatif : UNE0065/20
 Filtration + 95%
 25 lavages

TAILLES:
 Enfant 6-9 ans: 6,5 x 15 cm. (Sur demande)
 Enfant 9-12 ans: 8,5 x 17 cm.
 Adulte: 12 x 18 cm.

Personnalisation à partir de 50 unités (Prix unitaire).
 Ce produit ne doit pas être considéré comme un dispositif médical ou un équipement de protection (EPI).

🇬🇧 HYGIENIC, WASHABLE AND REUSABLE MASKS

The reusable hygienic mask is made of 3 layers of 100% polyester of 86g/ m². It has two elastics in order to fasten over the ears for more comfort. OEKO-TEX certified material®

BREATHABILITY: DIFFERENTIAL PRESSURE: ≤ 60
 Normative : UNE0065/20
 Filtration + 95%
 25 Washes

SIZES:
 Child 6-9 years: 6.5 x 15 cm. (on request)
 Child 9-12 years: 8.5 x 17 cm.
 Adult: 12 x 18 cm.

Customization from 50 units (Price per unit).
 This product should be considered neither as sanitary nor as protective equipment (EPI).

🇩🇪 HYGENISCHE, WASCHBARE UND WIEDERBRAUCHBARE MASKEN

Die wiederverwendbare Hygienemaske besteht aus 3 Lagen 100% Polyester von 240g/m². Sie hat zwei elastische Gummis mit Ohrbefestigung für besseren Komfort. Hergestellt aus dreilagigem Kompaktgewebe.

Dieses Produkt sollte nicht als sanitäres noch als Schutzausstattung betrachtet werden. Bakterielle Filtrationseffizienz (BFE): Nach 10 Mal waschen 75% (bescheinigt).

GRÖSSEN:
 Kind 6-9 Jahre: 6,5 x 15 cm. (auf Anfrage)
 Kind 9-12 Jahre: 8,5 x 17 cm.
 Erwachsener: 12 x 18 cm.

ATMUNGSAKTIVITÄT: DIFFERENZDRUCK: ≤ 60
 Bescheinigtes OEKO-TEX® Material
 Wird verkauft in Packungen mit 5 Stück (Preis pro Einheit).

ADULTO / ADULTE / ADULT / ERWACHSENER

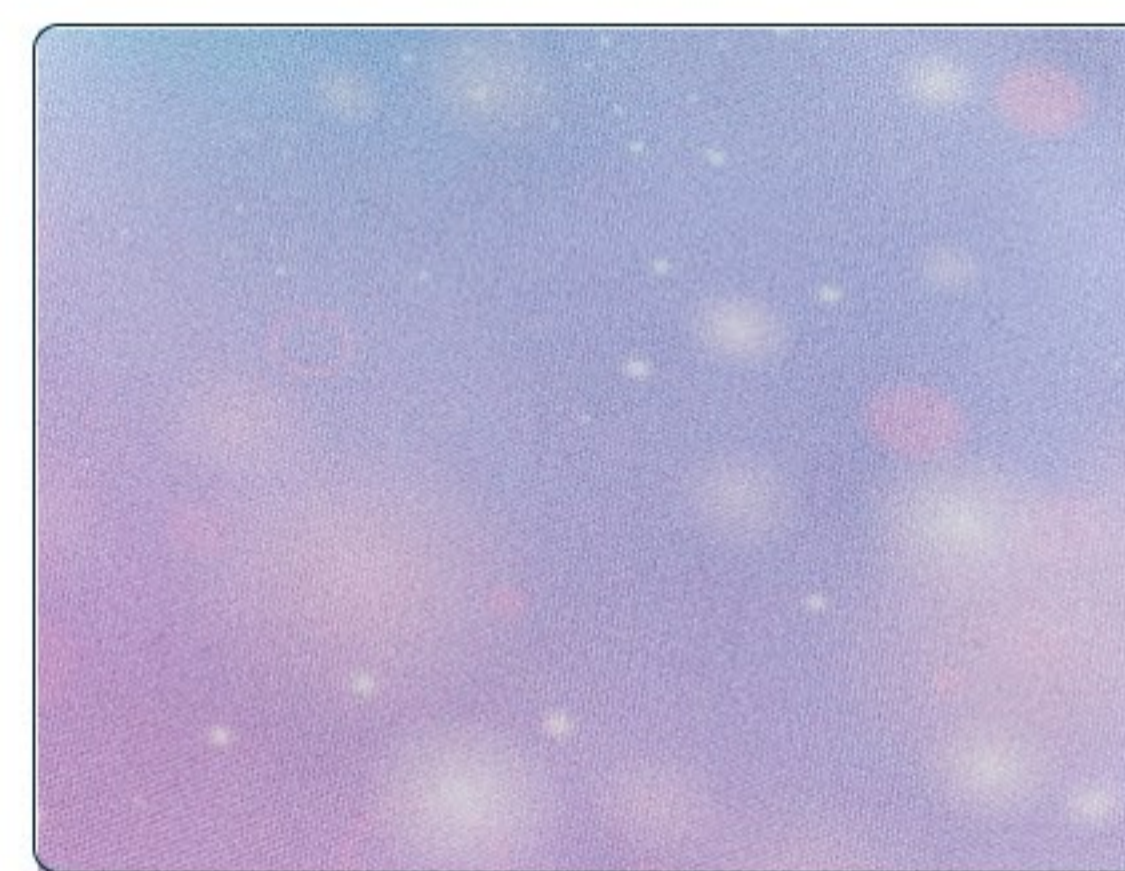
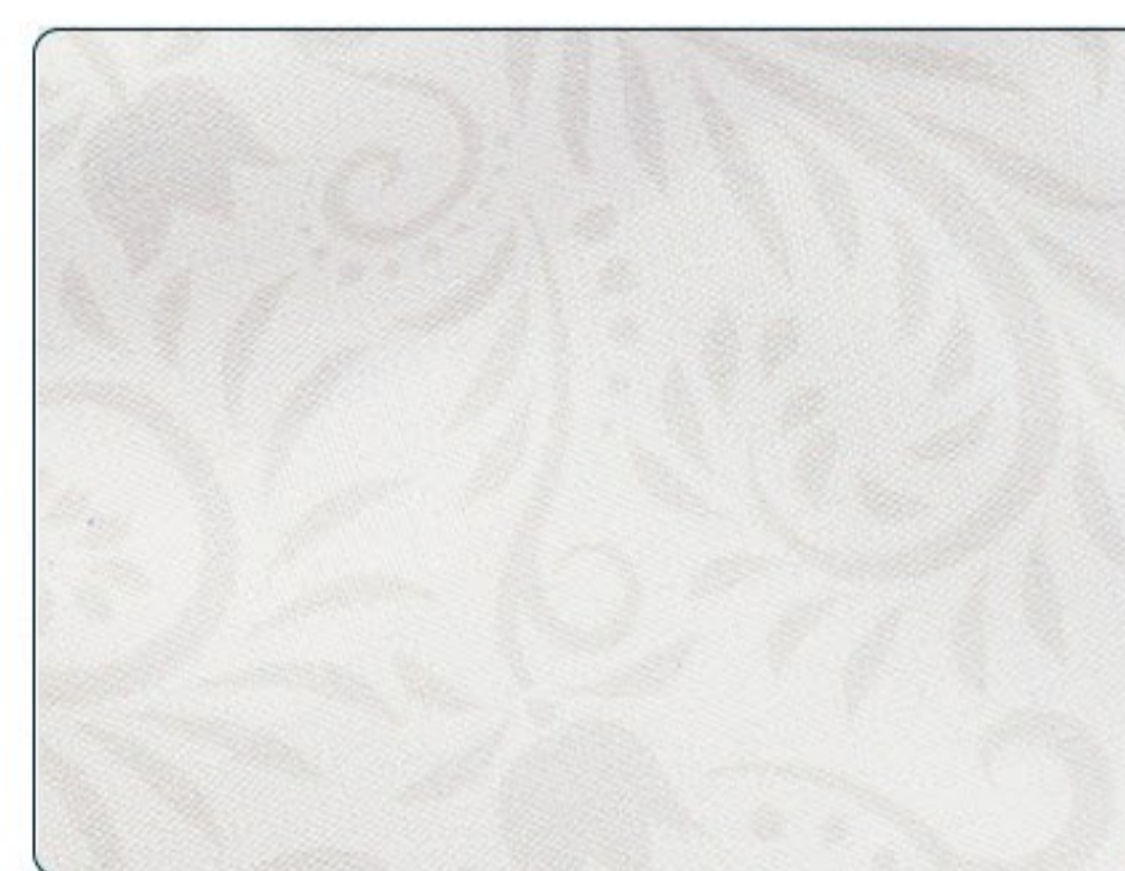
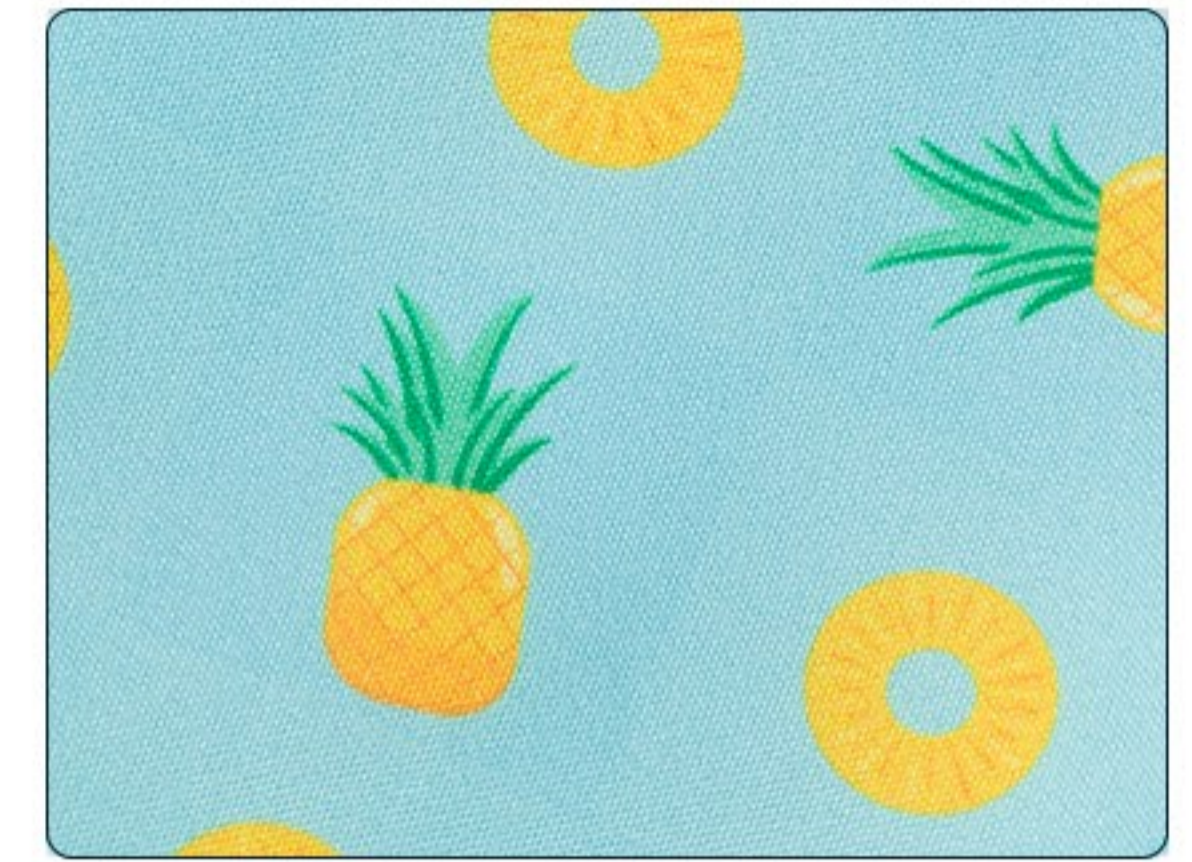
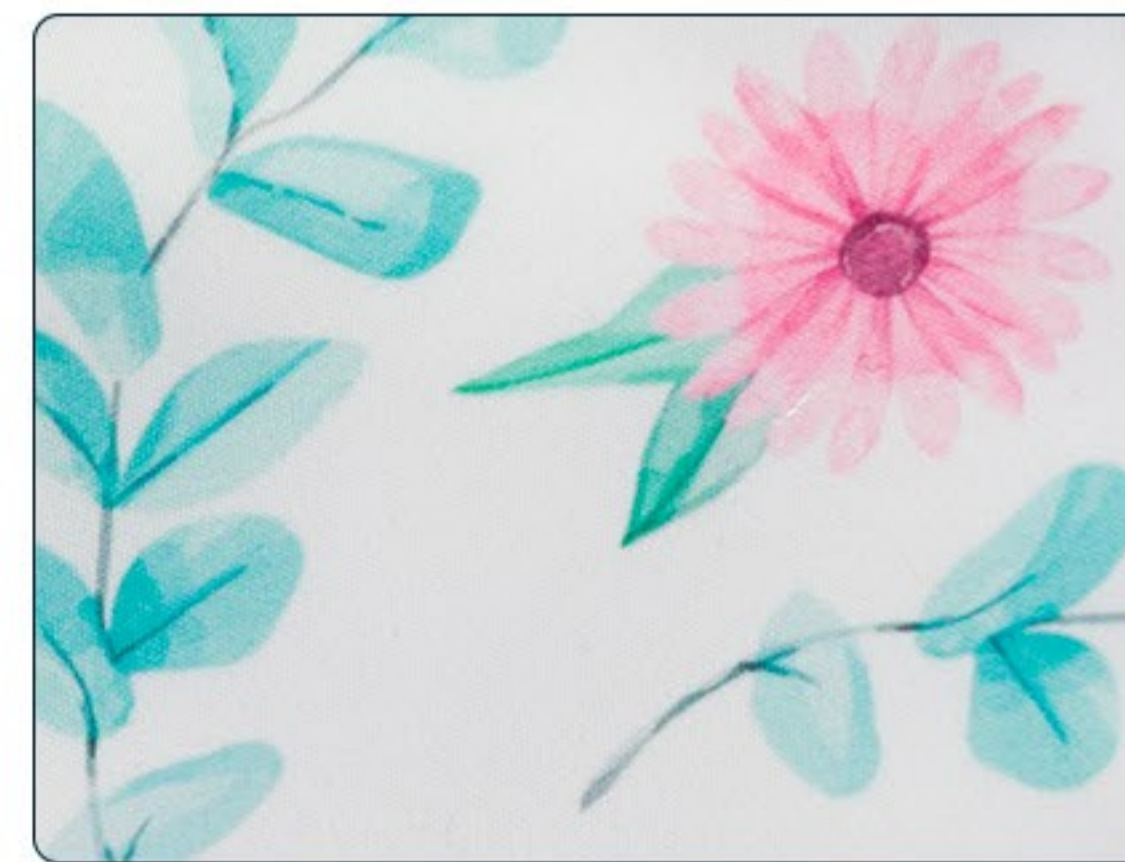

NIÑO 9 – 12 AÑOS / ENFANT 9-12 ANS / CHILD 9-12 YEARS / KIND 9-12 JAHRE



REF. M5



REF. M6



REF. M7



	A	Kg	€
Ref.: M5	12 x 18	0,012 Kg	8,00 €
Ref.: M6	12 x 18	0,012 Kg	8,00 €
Ref.: M7	12 x 18	0,012 Kg	8,00 €

REF. M8



REF. M9



REF. M10



	A	kg	€
Ref.: M8	12 x 18	0,012 Kg	8,00 €
Ref.: M9	12 x 18	0,012 Kg	8,00 €
Ref.: M10	12 x 18	0,012 Kg	8,00 €

REF. M11



REF. M12



REF. MKID1



	A	Kg	€
Ref.: M11	12 x 18	0,012 Kg	8,00 €
Ref: M12	12 x 18	0,012 Kg	8,00 €
Ref.: MKID1	8,5 X 17	0,012 Kg	8,00 €

EXPOSITOR DE SOBREMESA GIRATORIO PARA MASCARILLAS

Expositor metálico ideal para la colocación de mascarillas de protección, fabricado con tres niveles, cada nivel es giratorio 360 grados en los dos sentidos. Estructura metálica pintada en color plata, negro o blanco.

Capacidad: 120 mascarillas aproximadamente.

Empaquetado mascarillas: El expositor permite la colocación de mascarillas en los dos formatos, empaquetada doblada o empaquetado con la mascarilla extendida.

Ref.EM2 - Precio Expositor más 120 mascarillas de la ref. M4. : 309€

PRÉSENTOIR DE TABLE ROTATIF POUR MASQUES

Présentoir en métal idéal pour le placement de masques de protection, composé de trois niveaux, chaque niveau est pivotant à 360 degrés dans les deux sens. Structure métallique peinte en argent, noir ou blanc.

Capacité: 120 masques environ.

Emballage des masques: L'unité d'affichage permet le placement de masques dans les deux formats, emballage plié ou emballage avec le masque étendu.

Ref.EM2 - Prix présentoir plus 120 masques de la réf. M4. : 309€

TURNING TABLE DISPLAY FOR MASKS

Metallic display ideal for the placement of protective masks, manufactured with three levels, each level rotates 360 degrees in both directions. Metallic structure painted in silver, black or white.

Capacity: approximately 120 masks.

Packaging for the masks: The display allows the placement of masks in both formats, packaged folded or packaged with the extended mask.

Ref.EM2 - Exhibitor price plus 120 ref M4 masks. : 309€

DREHENDES TISCHDISPLAY FÜR MASKEN

Metallisches Display ideal für die Platzierung von Schutzmasken, mit drei Ebenen hergestellt, jede Ebene dreht sich um 360 Grad in beide Richtungen. Metallstruktur in silber, schwarz oder weiß lackiert.

Kapazität: ca. 120 Masken.

Verpackungen der Masken: Das Display ermöglicht die Platzierung von Masken in beiden Formaten, gefaltet verpackt oder mit der offenen Maske verpackt.

Ref.EM2- Preis des Displays mit 120 Masken der Ref. M4. : 309€

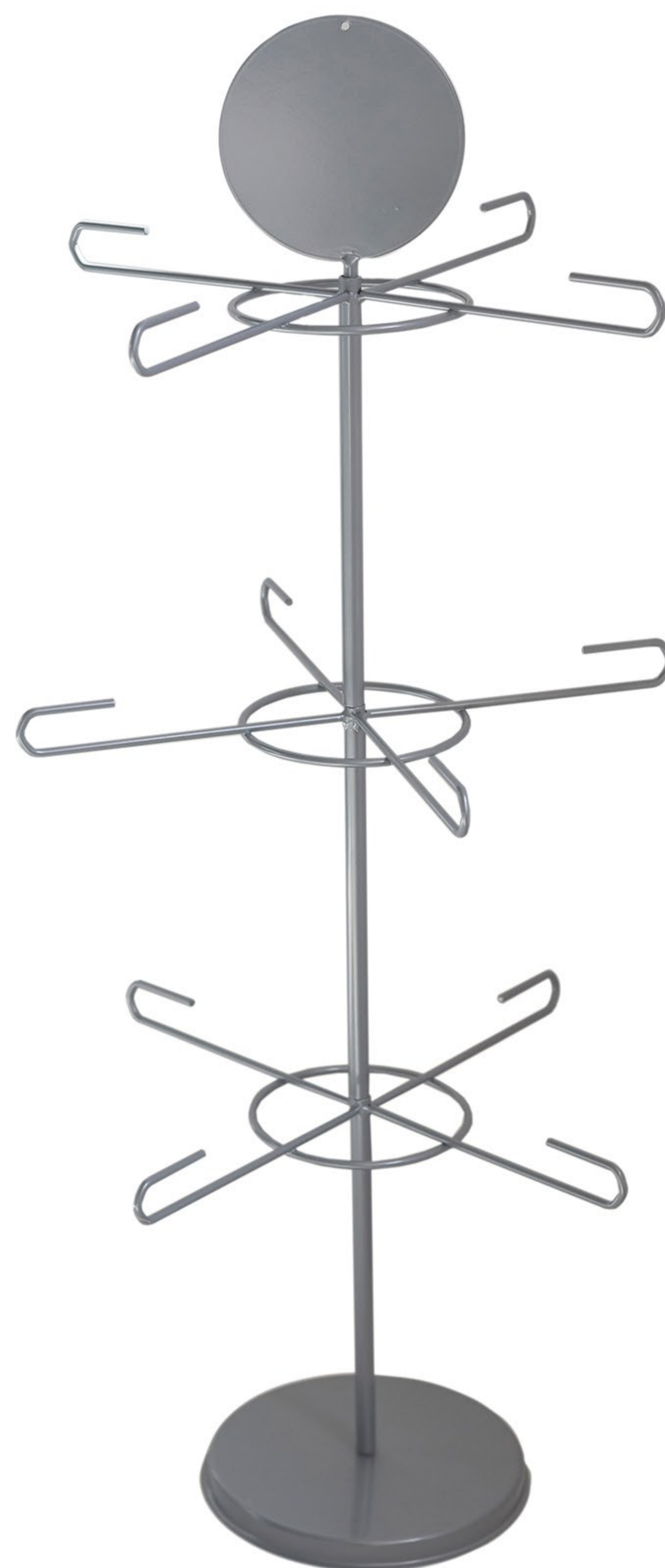

Ref. EM1.

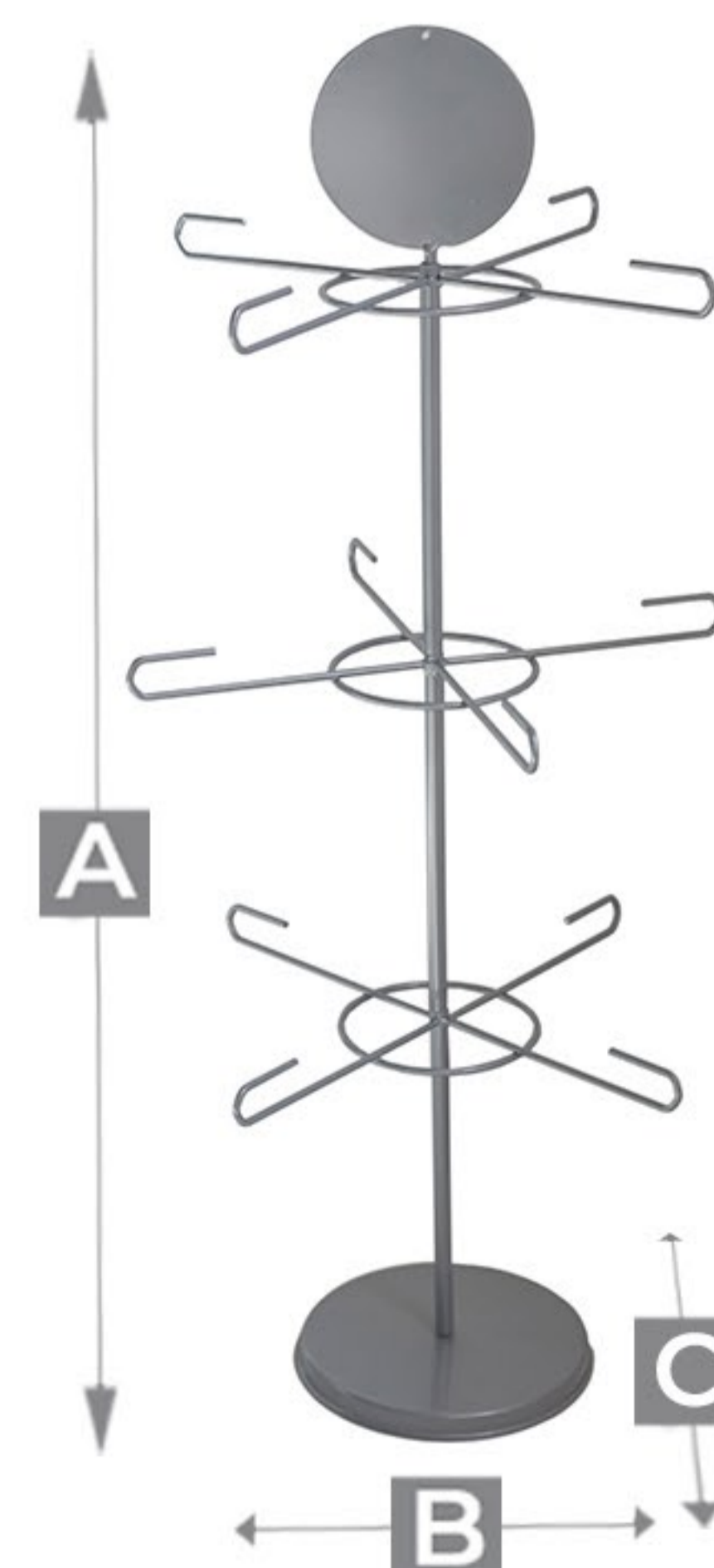

	A	B	C	Kg	€
Ref.: EM1	88 cm	38 cm	38 cm	2,02 Kg	39,97 €
Ref.: EM2	88 cm	38 cm	38 cm	3,46 Kg	309,00 €

